

Advance MVHR



Installation and User Guide



Stock Ref. N°

405215 Advance S
473881 Advance S Ventwise
405216 Advance SX
407808 Advance Sp LH
407809 Advance Sp RH
474020 Advance SXp LH
474025 Advance SXp RH



**PLEASE READ THESE INSTRUCTIONS CAREFULLY
BEFORE COMMENCING INSTALLATION OR OPERATION.**

**PLEASE REFER TO ACCOMPANYING DOCUMENTATION
FOR INFORMATION SPECIFIC TO YOUR UNIT.**

**PLEASE RETAIN THESE INSTRUCTIONS WITH THE
PRODUCT.**

476930



- Do not install this product in areas where the following may be present or occur:
 - Excessive oil or a grease laden atmosphere.
 - Corrosive or flammable gases, liquids or vapours.
 - Subject to direct water spray from hoses.
 - Ambient temperatures higher than 40°C and lower than -20°C.
 - Possible obstructions that may hinder access to or removal of the unit.
- All wiring must be in accordance with the current IEE wiring regulations BS7671, or appropriate standards of your country. Installation should be inspected and tested by a suitably qualified person after completion.
- Ensure the mains supply (voltage, frequency and phase) complies with the rating label.
- The unit should be provided with a local double pole fused spur fitted with a 3A fuse having a contact separation of at least 3mm. If a unit fitted with a preheater is being installed, a 13A fuse should be used.
- These units must be earthed.
- Precautions must be taken to avoid the back-flow of gases into the building from the open flue of gas or other fuel-burning appliances.
- This appliance is not intended for use by persons (including children) with reduced physical, sensory or mental capabilities, or lack of experience and knowledge, unless they have been given supervision or instruction concerning use of the appliance by a person responsible for their safety.
- Young children should be supervised to ensure that they do not play with the appliance.
- The installer is responsible for the installation and electrical connection of the sentinel system on site. It is the responsibility of the installer to ensure that the equipment is safely and securely installed and left only when mechanically and electrically safe.
- All regulations and requirements must be strictly followed to prevent hazards to life and property, both during and after installation, and during any subsequent servicing and maintenance.
- The unit's condensate drain must be connected to the building's wastewater drainage system.
- Certain applications may require the installation of sound attenuation to achieve the sound levels required.
- The unit must not be connected directly to a tumble drier.
- The supply and exhaust valves must be fully opened prior to commissioning.
- The intake air must be drawn from the exterior of the property.
- The unit should be allowed to stabilise during commissioning for a minimum period of 5 minutes when changing between boost and normal speeds.
- Ensure that the unit's external grilles are a minimum of 1500mm apart. The exhaust grille should be located at least 600mm away from any flue outlet. The inlet grille should be located 2000mm away from any flue outlet.
- This product and associated duct installation should be carried out in accordance with the Domestic Ventilation Compliance Guide.

UK Building Regulations (Part F) Declaration of Conformance

The unit conforms to the 2010 Building Regulation (Part F - Means of Ventilation, F1(1), F(2)) requirements for fixed systems for mechanical extract fans when installed in accordance with the instructions in this document and the Domestic Ventilation Compliance Guide

Operation and Monitoring	4
Product Description.....	4
Controlling the unit	5
Touch screen display	5
Control via WiFi.....	5
User controls.....	6
Settings and Performance.....	7
Control Unit Screens Summary	12
Control Unit Screens Summary	13
Maintenance	14
Filter Maintenance.....	14
Periodic Maintenance.....	15
Spares	16
Troubleshooting	17
Diagnosing a Problem	17
Installation	18
Overview.....	18
Wall Mounting the Unit	19
Floor Mounting the Unit.....	20
Floor Mounting the Unit (Alternate Method).....	21
Vertical Discharge Condensate Installation	22
Attach the Ducting.....	23
Electrical Installation	24
Connect Switches and Sensors.....	25
Connect the Power Supply.....	27
Commissioning	28
Powering up the Unit.....	28
Overview.....	28
Control Unit Touch Screen Display.....	28
Modifying Settings.....	29
Commissioning Screens Summary.....	30
Modifying Commissioning Settings.....	32
Commissioning the Unit via USB.....	41
Accessories	42
WiFi Controller	42
Ventwise Accessory	46
Input Switch Accessory	50
Switched Live Expansion PCB Accessory	52
Analogue Input PCB Accessory	54
Wired Remote docking Kit Accessory.....	56
Technical data	58
Flow Rate settings.....	58
Frost Protection.....	58
Summer Bypass Mode.....	59
Product Dimensions	60
Spares	61
Default settings	62
Disposal.....	64

Product Description

Mechanical Ventilation/Heat Recovery (MVHR). This heat recovery unit is designed for the energy efficient ventilation of houses and similar dwellings, conforming to the latest requirements of the Building Regulations document F 2010.

The unit is designed for continuous 24 hour extract ventilation of stale moist air from bathrooms, toilets, utility rooms and kitchens. As the stale air is extracted, a heat exchanger within the unit transfers up to 93% of the extract air's heat, into the supply air entering the bedrooms and lounge. This provides significant energy recovery, reducing household heat costs, and providing the optimum comfort conditions.

In addition, some models will have features that maintain a constant airflow independent of the blocked filters.

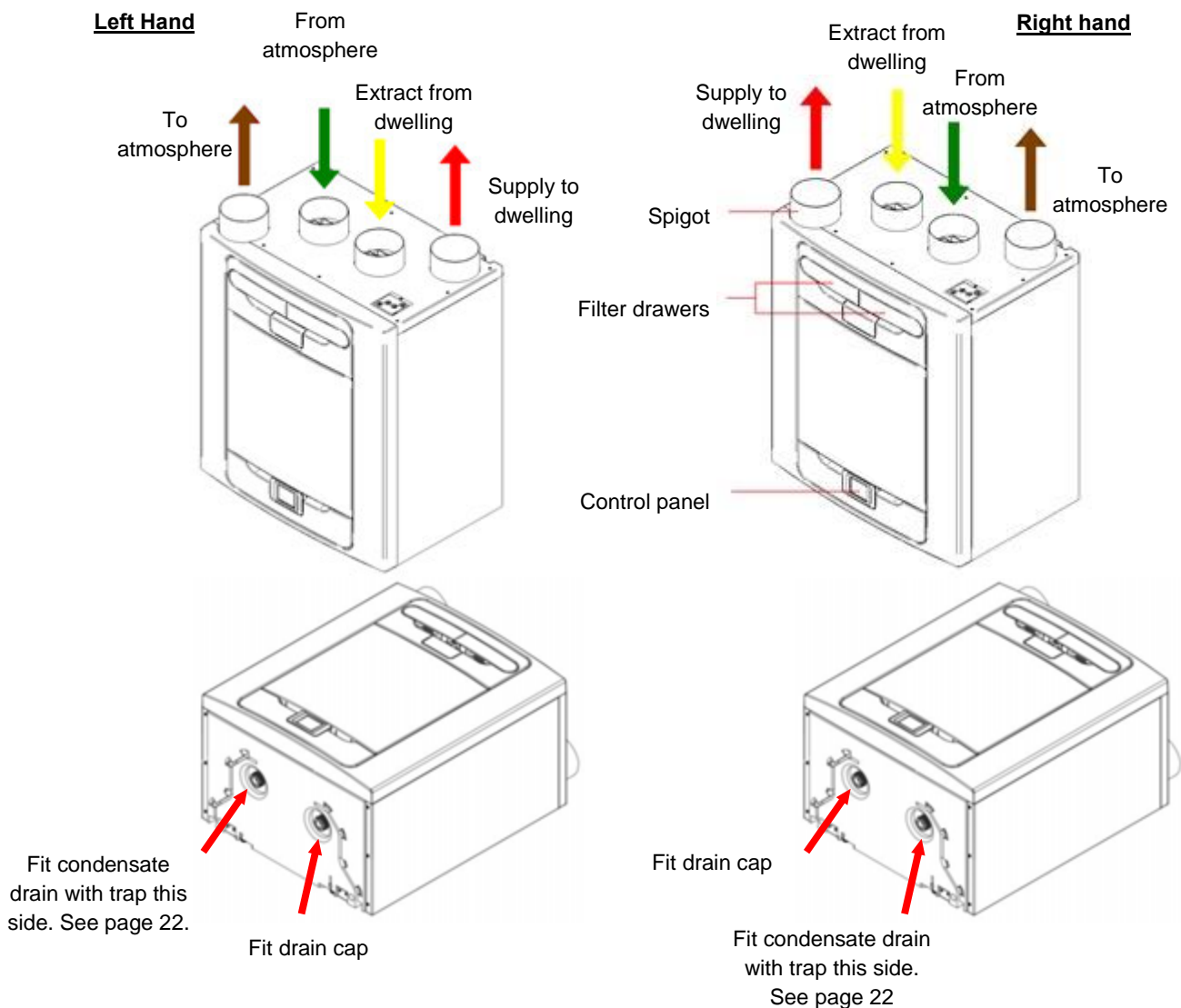

Figure 1: MVHR with Left Hand and Right Hand spigot configuration.

Units with a preheater are preconfigured from the factory and the handing cannot be changed.







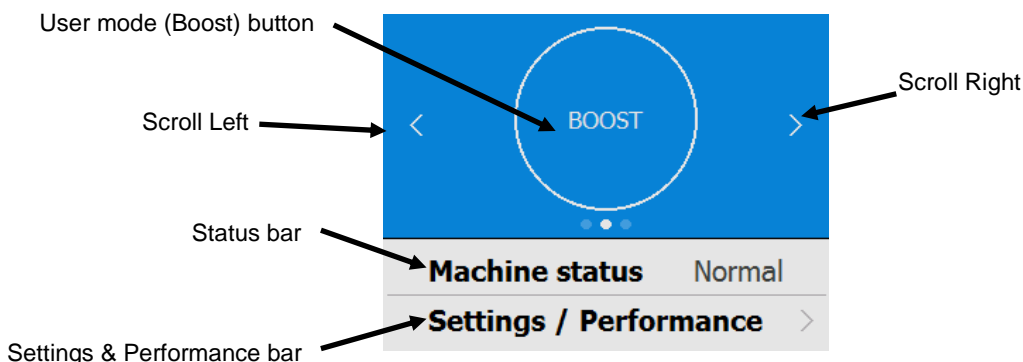

Controlling the unit

The unit can be controlled via the Touch screen display, via WiFi, switched inputs, or via a third party building control system.

Touch screen display

The touch screen display can be located on the front of the unit or connected to the unit via a remote docking kit. The Control Unit provides the user interface for commissioning and monitoring purposes. The display is a resistive touchscreen with LED backlight, which will turn off to automatically after 5 minutes to minimise power consumption. To activate the backlight, touch the display.



Navigate through the functions by pressing the      symbols, adjust settings using the   buttons. A  symbol indicates that there are further screens related to a menu option. Select the option on the touchscreen to access the related screens.

Control via WiFi

The MVHR WiFi controller is a plug & play accessory that fits next to the control module. It allows the user instant access to commissioning, configuration, direct monitoring and control of the MVHR unit, using a smart phone or tablet with the app, available from the iTunes Store or on Google Play. See page 43 for App address.



User controls

User Menu Home Screen

The user menu home screen, consists of a User Mode (BOOST) button, a Machine status bar, and a Settings / Performance bar.

The Machine status scrolls through Mode of operation, Summer bypass status and Frost protection status.

Press Settings / Performance to access these menus.

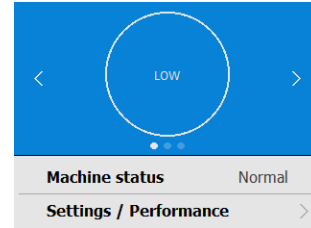

User Mode

Scroll through the pre-defined user modes (factory defaults are BOOST, LOW, and PURGE) using the < > buttons either side of the User Mode button. Select the required function by pressing the centre button.

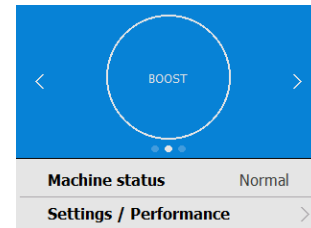

When a user mode is selected, select the duration by pressing the required button from the four options on the screen.

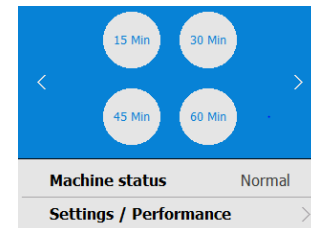

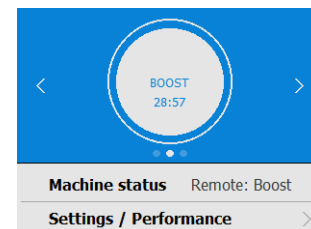

The button will appear white and the user mode will flash. A countdown clock will also appear showing the time remaining for the selected User Mode.

Pressing the User mode button again will cancel the User Mode and the unit will default back to Normal mode.



Settings and Performance

Settings

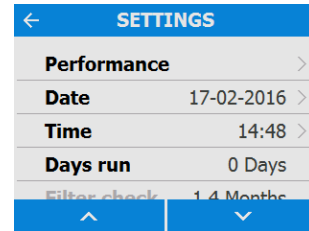

Scroll through the settings using the  &  buttons and select using  where applicable to access Language, Date, Time, Reset filter, Display settings, Summer Bypass, Mode Scheduling, Service phone, Commissioner Menu & Diagnostics.

Days Run and Filter check are reported values and do not have editable parameters in this section.



Performance



The performance menu shows key performance indicators such as recovered Temperature and Estimated power consumption.

Scroll through the list using the  &  buttons and select the required parameter.

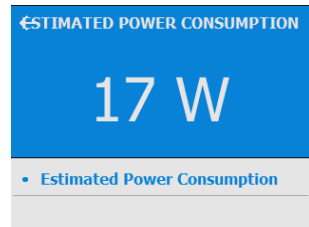
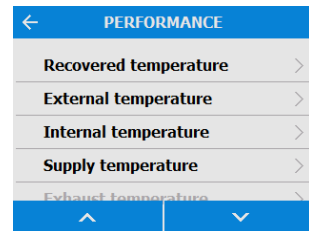
Each performance temperature can be shown in Celsius or Fahrenheit by pressing the required temperature.



Date

Change the date using the  /  buttons on the screen.

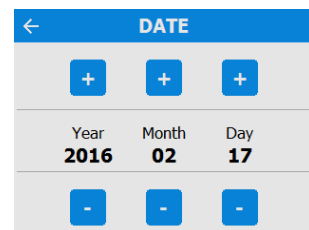

Time

Change the time using the **+** / **-** buttons on the screen.

Note: The clock is 24 hour

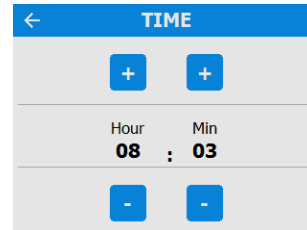

Clean/Replace Filter

After maintenance or replacement of the filters, the filter timer can be reset by pressing NOW.

Press LATER to return to the Settings Menu.

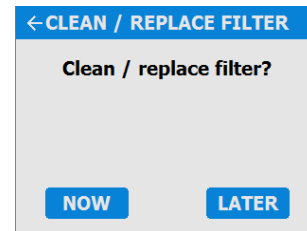

Display Settings

Change the brightness of the touch screen using the **+** / **-** buttons.

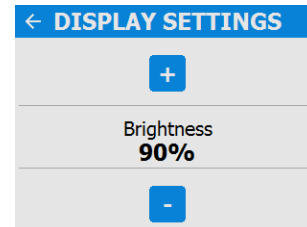

Summer Bypass

See page 9 for a full description of the Summer Bypass modes and functions

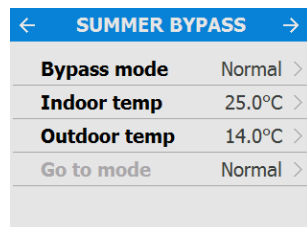

Select the required bypass mode.

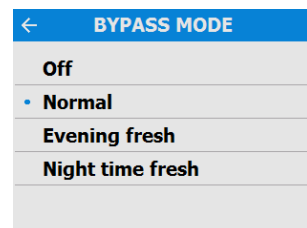

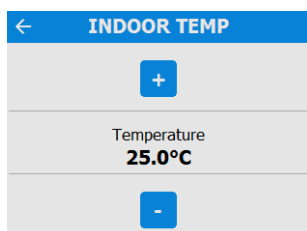

The indoor temperature setting is the maximum desired room temperature. This should be set to 3° above the central heating temperature.

Change the indoor temperature using the **+** / **-** buttons on the screen.



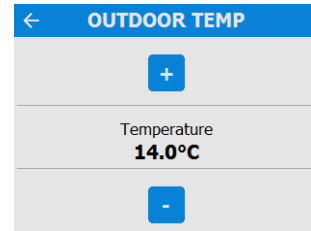

The outdoor temperature is the minimum air temperature that the bypass will permit. This is to prevent cold draughts.

Change the outdoor temperature using the  /  buttons on the screen.



This is the mode the bypass will switch to when activated.

The suggested Mode for Evening fresh and Night time fresh setting is Boost.

Scroll through the settings using the  &  buttons and select the Go To mode.

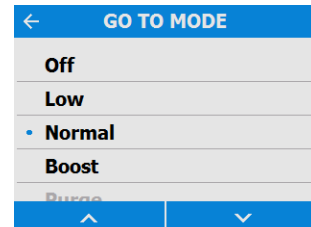

Note: Number of available modes may differ from image shown depending on bypass setting and the modes set in the commissioning process.

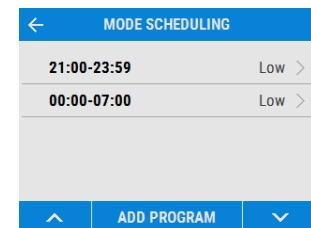

Mode Scheduling

Use a schedule to set a Mode (Airflow setting) for a fixed, repeated period. For example, set Boost Mode every morning between 7:00am and 8:00am while cooking breakfast.



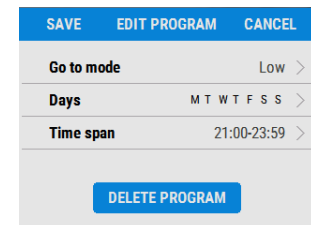

Select the Schedule to view the settings

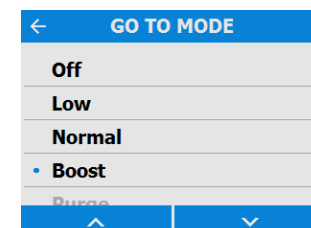

Scroll through the settings using the  &  buttons and select the Go To mode for each Schedule.



Scroll through the days of the week using the  &  buttons and select each day to be included in the Schedule program.

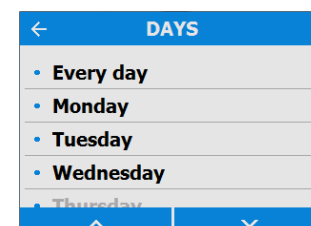

Adjust the start and finish times for each day using the **+** / **-** buttons.

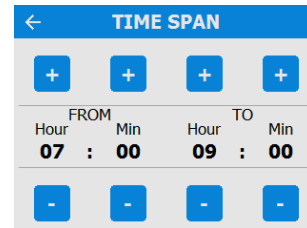

Silent Hours

Silent Hours mode is useful to impose a speed/flow restriction on the unit to minimise unwanted noise during the night.

If Silent hours are enabled, the unit will not speed up above the set Maximum Mode. Silent Hours can be set to reoccur on specific days and times.

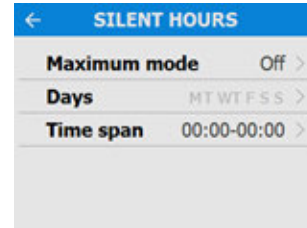

Service Phone

The service phone number can be entered by the installer and should be used if the unit displays a fault code, or to arrange routine servicing for the unit.

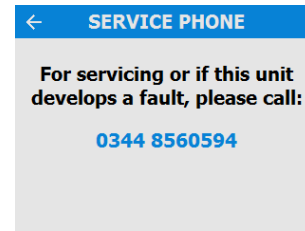



Commissioning Menu

Enter the lock code using the **+** / **-** buttons to access the Commissioner Menu.

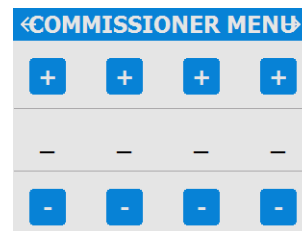

Note: the lock code is set by the installer and settings beyond this point should only be accessed and modified by a qualified installer.



Diagnostics

Scroll through the Diagnostics list using the  &  buttons to access the following information. Machine Status, Days Run, Filter Check, Bypass, Energy Consumption, Air flows, Option boards. Input status, Output Status, WiFi Status, WiFi signal.

Note: Optional upgrades may be necessary to view all information.

← DIAGNOSTICS	
Display version	1.3 ASSERT
Main board version	0
Model	S/Small
Serial	0
Machine status	Normal
Days run	0 Days
Filter check	1.4 Months
Bypass	Off
Estimated Power Consumption ⓘ	
Airflows	>
Option boards	>
Input status	>
Output status	>
WiFi status	- >
USB status	Not available
 	

Control Unit Screens Summary

The following Control Unit screens are available for daily operation and monitoring of the unit. Colour and visual appearance may be different to the below depending on model version and region.

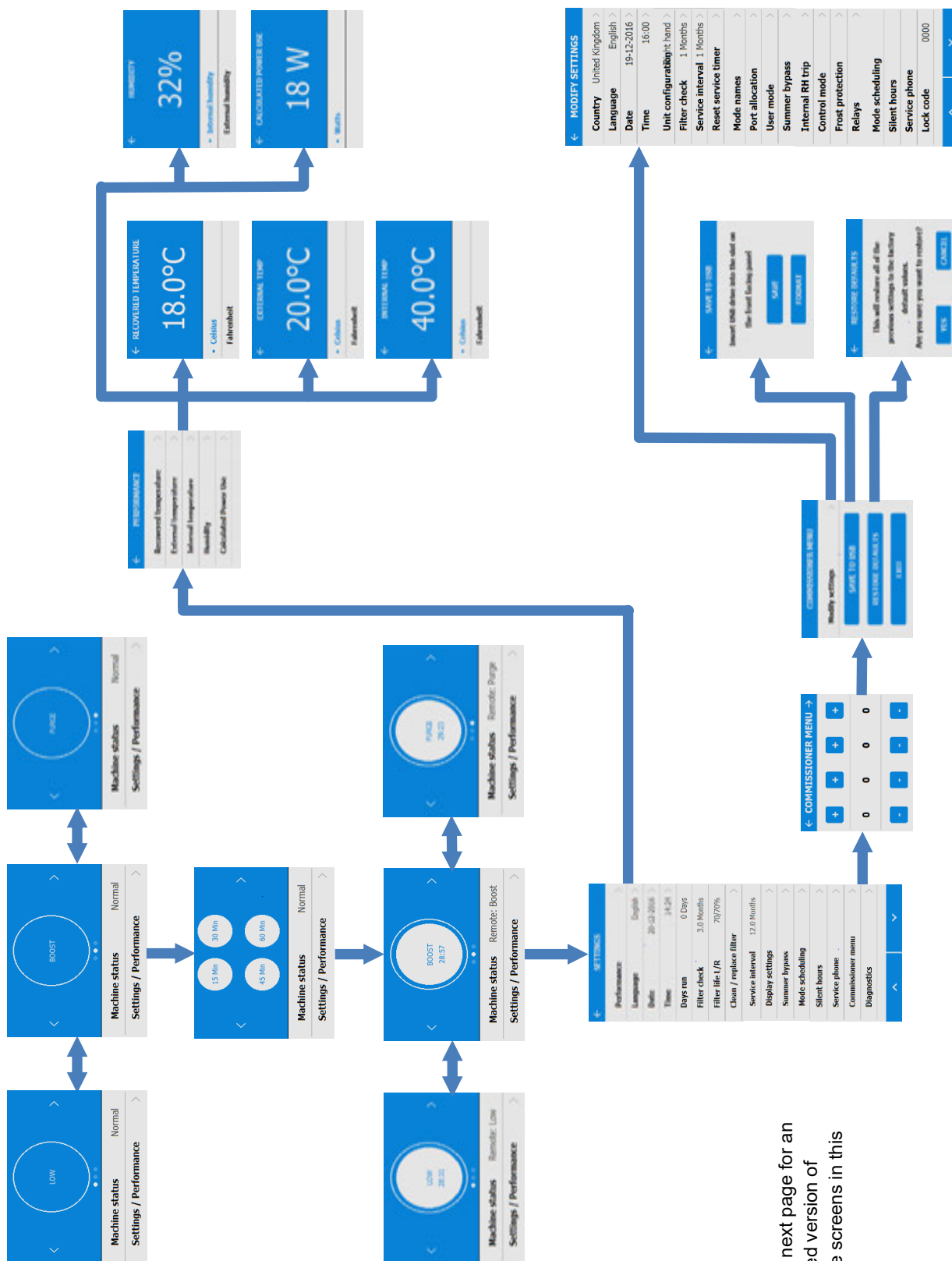

Refer to next page for an expanded version of available screens in this section.

Control Unit Screens Summary

The following Control Unit screens are available in the Settings / Performance section. Colour, visual appearance, and some features may be different to the below depending on model version and region.

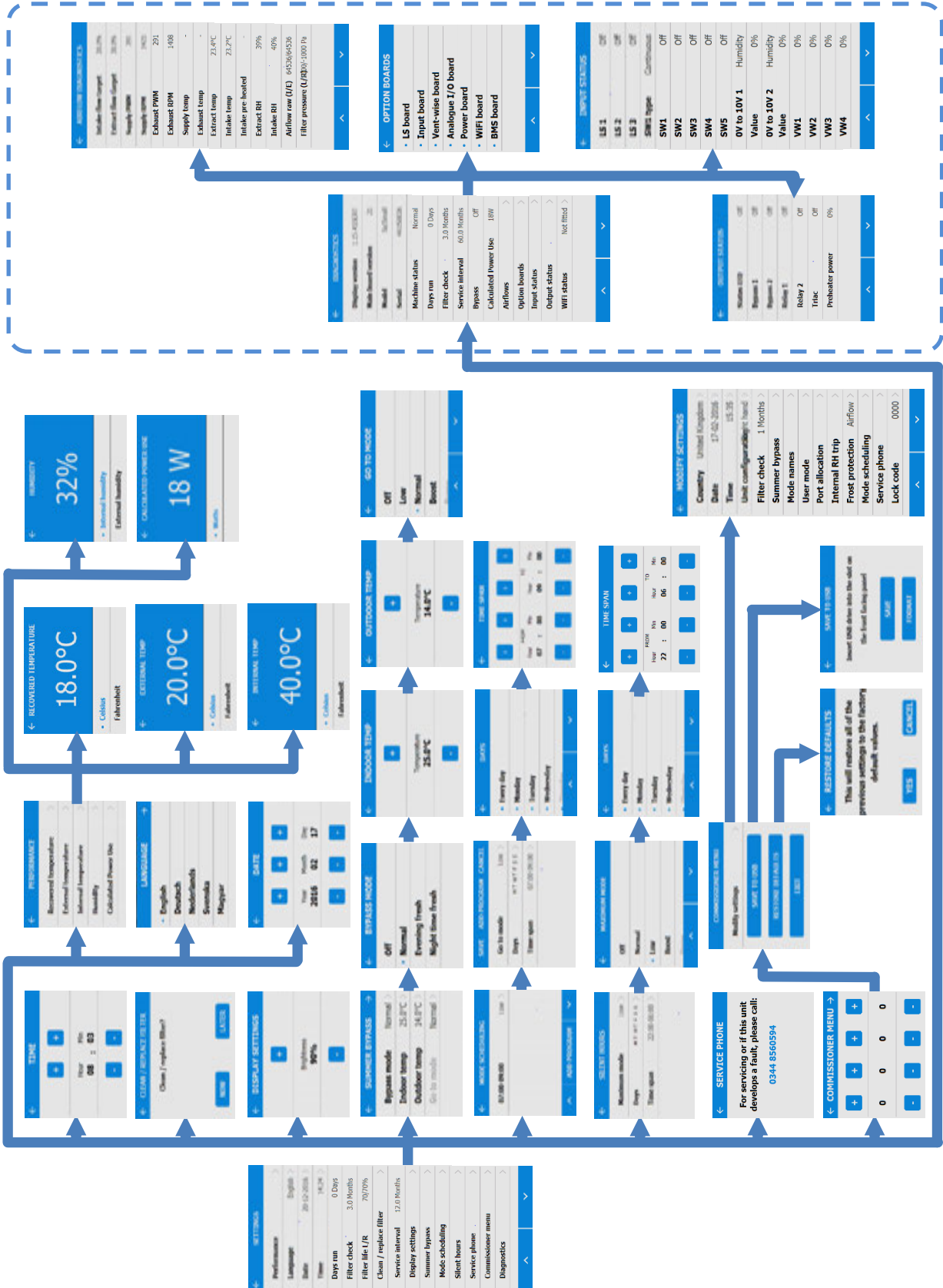

Filter Maintenance

Heat recovery units require regular maintenance.

This unit has been designed to facilitate access to enable maintenance to be carried out easily.

When the unit displays “Clean or replace filters”. This is a reminder to ensure that the filters are not so dirty that they are blocking the airflow or allowing dirt to pass through. The rate at which the filters become dirty will vary hugely depending on the environment and the activity within the property.

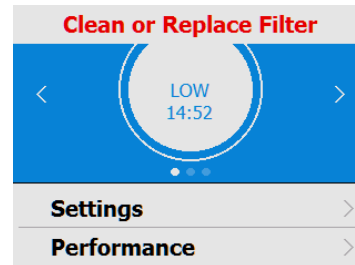

See page 61 for a list of spare filters.

1. Open the filter drawers by pressing the finger plate upwards and sliding the drawer out.

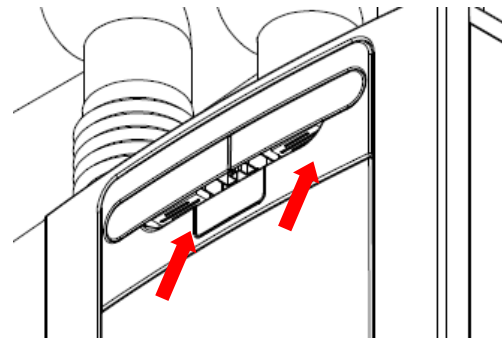

- 2. Lift each filter out and clean gently by tapping or carefully using a vacuum cleaner if necessary.
- 3. Replace the filters
- 4. Close the filter drawers, ensuring the latches have clicked back into the locked position.

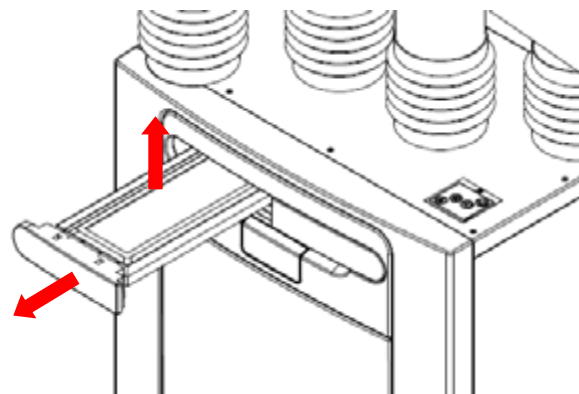

5. After maintenance of the filters, the filter timer can be reset by going to Settings/Performance, Clean/Replace filter.

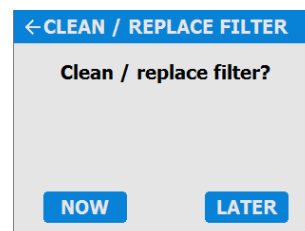

Periodic Maintenance



WARNING

THE FAN AND ANCILLARY CONTROL EQUIPMENT MUST BE ISOLATED FROM THE POWER SUPPLY DURING MAINTENANCE.

Fan Filters

Check fan filters as described on the previous page.

Heat Exchanger Cell

Step 1: Remove the outer cover by pressing the tabs either side of the control module and lifting the cover outwards from the bottom edge.

Step 2: Remove the inner door by undoing the 4 retaining screws.

Step 3: Slide the heat exchanger out from the unit.

Step 4: Wash the outer cover and heat exchanger in warm water using a mild detergent (such as Milton Fluid) and dry thoroughly.

NOTE: Keep water away from all electrical components and wiring within the unit.

Motors

Inspect the motors for build-up of dust and dirt on the impeller blades, which could cause imbalance and increased noise levels. Vacuum or clean if necessary.

Condensate Drain

Check the condensate drain tube is secure and clear of debris. Clean if necessary. Ensure the trap is fully charged with water.

Fastenings

Check that all unit and wall-mount fastenings are sufficiently tight and have not become loose. Re-tighten if necessary.

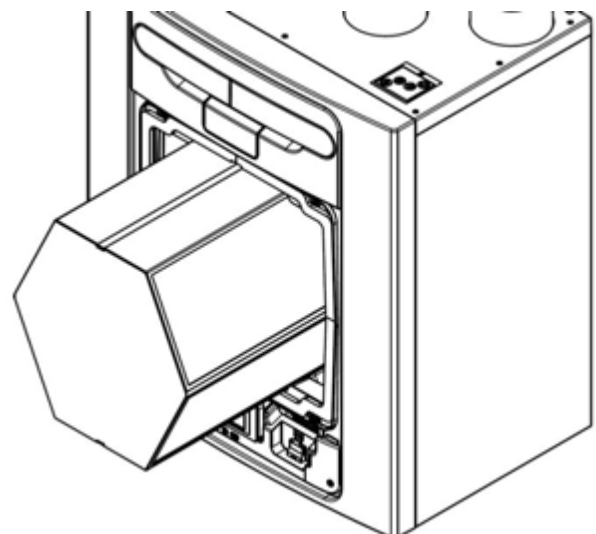
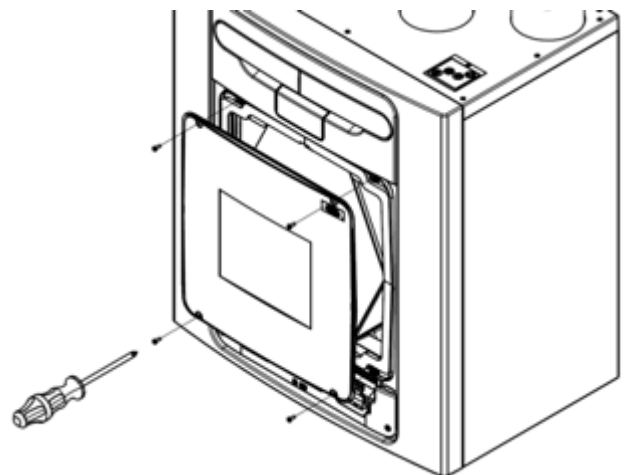
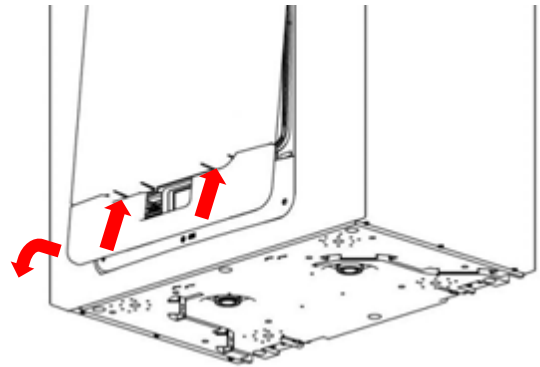

Spares

The following spare parts may be ordered from Vent-Axia:

Part No	Description
472663	Main Power Board
472665	Control Module
472667	Filters G3, 2 per pack
472669	Filters M5, 1 per pack
472671	Filters F7, 1 per pack
472673	Motor Scroll Assembly
472675	Summer Bypass Motor Assembly
472685	Temperature/Humidity Sensor T1 (Right)
472679	Temperature Sensor T2 (Left)
472687	Temperature/Humidity Sensor T3 (Left)
472683	Temperature Sensor T4 (Right)
474529	Constant Volume + Clean Filter Pressure Sensors PCBA

Table 3: Spare parts

Diagnosing a Problem

In the event of a problem, always troubleshoot the unit according to:

- **Warning code** displayed on the control unit.
A warning code is advisory and will not immediately stop the function of the unit.
- **Fault code** displayed on the Control Unit.
- **Fault LED** if connected.

If no indications are displayed, then troubleshoot problem according to the fault symptom as described in the following tables.

Service/Fault Code Screens

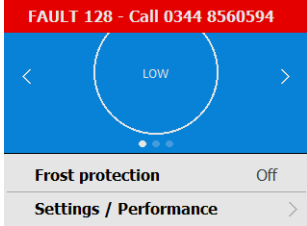
<p>The Fault Code notification is displayed, when a fault has occurred. Take note of the fault code when reporting a fault.</p>	
---	---

For assistance contact the service provider and quote the fault code number and the product serial number which can be found behind the front cover.

Note that the fault code is not displayed until the fault has been present for 3 minutes.

The following fault codes numbers may be displayed.

Code numbers are added together if more than one fault is detected.

For example: Code 03 indicates that both left and right fans are not running.

Code	Problem
01	Left Fan Fault
02	Right fan Fault
04	Left Thermistor Fault
08	Right Thermistor Fault
16	Left Centre Thermistor Fault
32	Right Centre Thermistor Fault
64	Left Centre Temp/Humidity Sensor Fault
128	Right Centre Temp/Humidity Sensor Fault

Table 4: Fault Codes

Overview

Before installation of the unit

We advise installers to fix all mains and sensor wiring along with any internal accessories prior to fixing the MVHR unit in position, leaving approximately 500mm tails to allow for internal routing.

Inspect the Unit

When taking delivery of the unit, check the items delivered against the enclosed delivery note. Inspect the unit for damage in transit. If in doubt, contact Customer Services. Each box contains a heat recovery unit, a wall bracket and accessory pack containing miscellaneous fixings and product documentation.

Unit Installation

Installation should be carried out by a suitably qualified and competent person.

If the unit is wall mounted, the wall should have sufficient strength to support the unit

The unit may also be floor mounted, either directly to the floor or using standard kitchen cabinet feet (not supplied). Ensure that the unit is mounted upright.

Do not use this unit as a support for any other equipment.

Service Void

Clearance must be left around the unit to allow for cleaning and servicing, the dimensions below are the minimum requirements. The condensate drain trap used will dictate the necessary clearance below the unit which may be larger than the minimums.

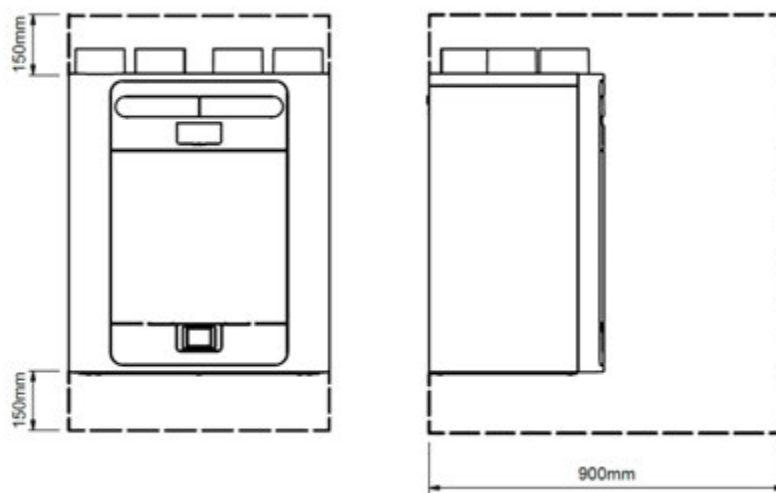

Select Unit Configuration

The unit is configurable as either Left or Right Handed (Default), see page 4 for the spigot configuration. Use the left hand condensate drain for the Left Hand configuration, the right hand drain for the Right Hand configuration. If the unit is fitted with a preheater, the configuration is factory set and cannot be altered.

Wall Mounting the Unit

Step 1: Mark the wall bracket position using the dimensions shown. Note the position of the top of the unit in relation to the wall bracket. Ensure the bracket position is horizontal.

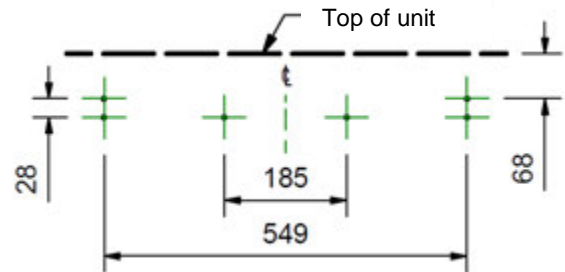

Step 2: Attach the wall bracket to the wall using appropriate fixings.

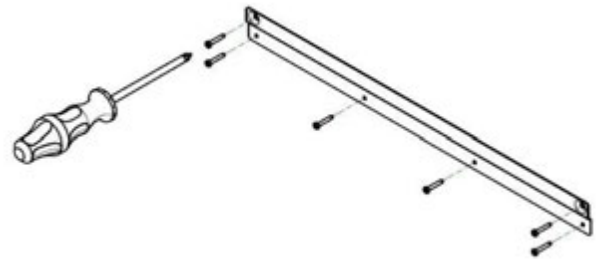

Step 3: Lift the unit and locate the two hooks on the rear onto the wall bracket.

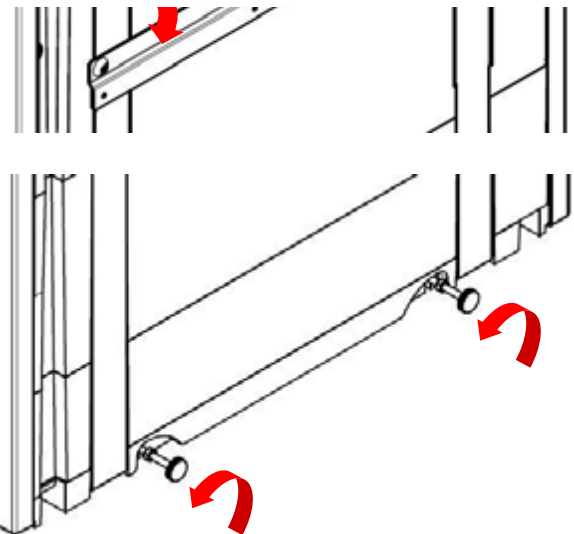

Step 4: Use the two adjusters at the bottom of the unit to ensure the base of the unit is horizontal in both axis. Lock the adjusters in the correct position using the two M6 nuts.

Floor Mounting the Unit

Step 1: The unit has 44 x 12mm deep fixing holes on the underside suitable for a No.6 screw. Pre drill a board using the dimensions shown, and cut 2 x 105mm minimum diameter holes for the condensate drain access.

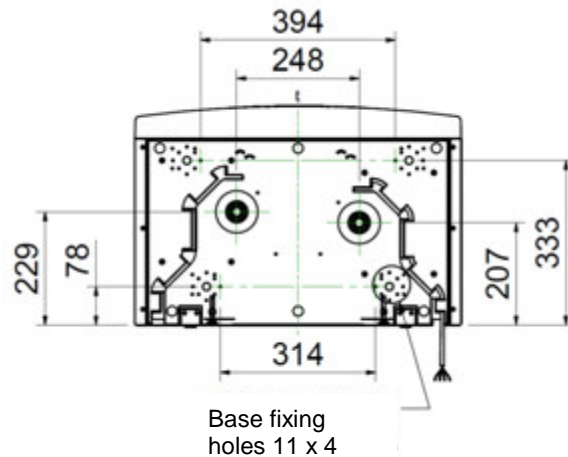

Step 2: Mount the board to the underside of the unit using appropriate fixings.

Note: Ensure any other cabling requirements (e.g. sensor, control cables etc) are routed through the two cable channels as required prior to attaching the board.

The board may then be attached to joists, flooring, or equivalent.

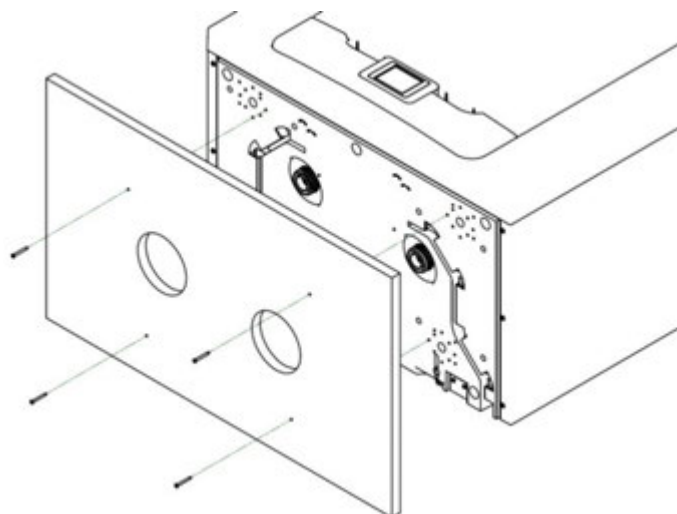

Vent-Axia recommend that where possible, the wall bracket is used in conjunction with any floor mount solution to prevent the unit from tipping.

Step 3: Mark the wall bracket position using the dimensions shown. Note the position of the top of the unit in relation to the wall bracket. Ensure the bracket position is parallel to the floor.

Step 4: Attach the wall bracket to the wall or batten using appropriate fixings. (As shown on page 19)

Step 5: Lift the unit and locate the two hooks on the rear onto the wall bracket prior to fixing the unit to the floor. (As shown on page 19)

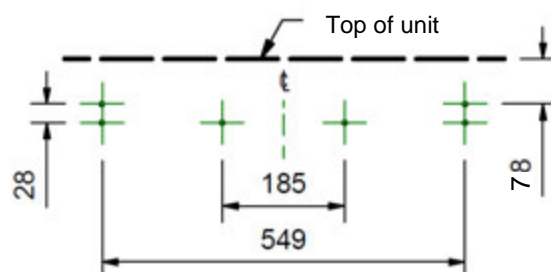

Floor Mounting the Unit (Alternate Method)

Step 1: The unit has 44 x 12mm deep fixing holes on the underside suitable for a No.6 screw. The holes are configured to allow fitment of most standard kitchen foot types (not supplied).

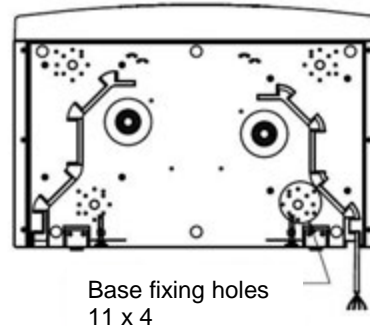

Step 2: Mount your chosen foot type to the underside of the unit using appropriate fixings.

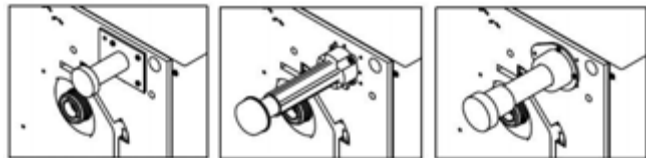

Step 3: Adjust your chosen foot type to ensure the base of the unit is horizontal in both axis.

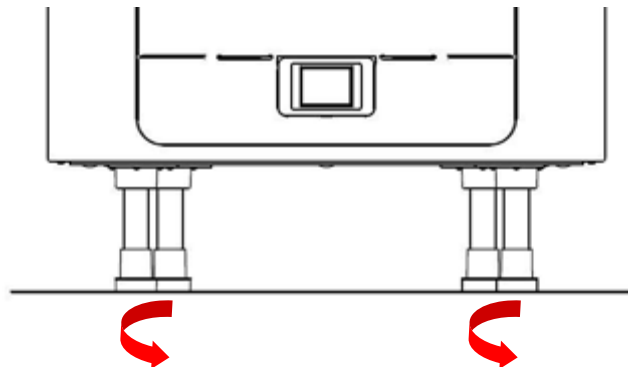

It is recommended that where possible, the wall bracket is used in conjunction with any floor mount solution to prevent the unit from tipping.

Step 4: Mark the wall bracket position using the dimensions shown. Note the position of the top of the unit in relation to the wall bracket. Ensure the bracket position is parallel to the floor.

Step 5: Attach the wall bracket to the wall or batten using appropriate fixings. (As shown on page 19)

Step 6: Lift the unit and locate the two hooks on the rear onto the wall bracket prior to fixing the unit to the floor. (As shown on page 19)

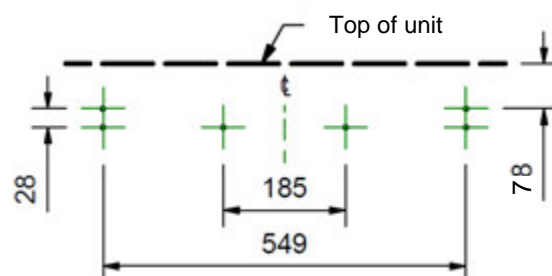

Vertical Discharge Condensate Installation

Note

A water trap with at least a seal of 60mm or a HepVo valve must be fitted between the unit and the rest of the waste system.

The condensate outlet is compatible with standard 22 mm plastic solvent weld fittings and 32mm plastic waste pipe fittings.

Wastepipes must have a 3 degree minimum angle to allow the water to drain away from the unit naturally.

In areas where freezing weather conditions occur, outlet pipes must be insulated to avoid blockage by ice, which may cause damage to the unit and surroundings.

This guide shows a Right Hand configuration for illustration.

If the unit is configured as Left Hand, then the condensate drain should be installed on the left with the blanking cap on the right.

22mm waste pipe

Solvent weld a small piece of 22mm plastic waste pipe to the (RH) condensate outlet.

Attach the appropriate pipe fittings for your installation. Always use a demountable coupler close to the unit.

Fit a water trap with a seal of at least 60mm, or a HepVo valve close to the unit.

Fit the blanking cap supplied with the unit to the appropriate side of the unit, depending on the handing of the unit, see page 4. Ensure the sealing gasket is fitted inside the blanking cap.

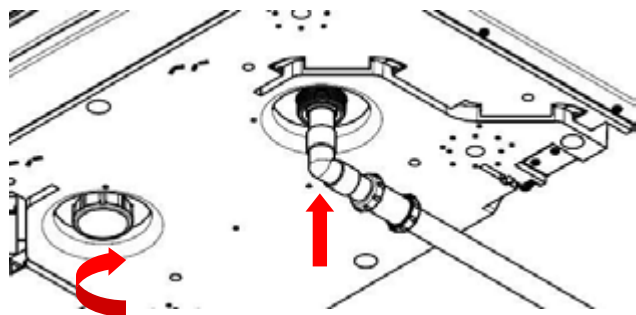
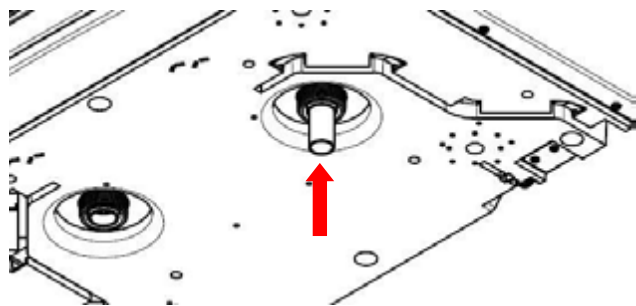

32mm waste pipe

Attach the appropriate pipe fittings for your installation to the (RH) condensate outlet.

Fit a water trap with a seal of at least 60mm, or a HepVo valve close to the unit.

Fit the blanking cap supplied with the unit to the appropriate side of the unit, depending on the handing of the unit, see page 4. Ensure the sealing gasket is fitted inside the blanking cap.

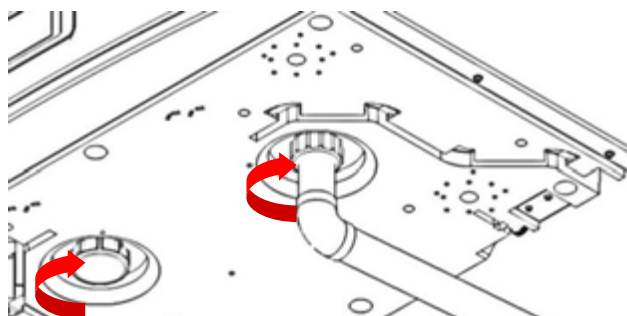

Attach the Ducting

1. Always use a short piece of insulated flexible duct maximum 150 mm long, extended to its full length when connecting to ductwork.
2. Securely connect the ducting to the spigots using worm-drive clips or suitable plastic ties.
3. Insulate any ducting passing through an unheated space to prevent any heat losses or surface condensation.
4. Insulate all ducting to and from outside vents.

All ducting must be installed in accordance with the Domestic Ventilation Compliance Guide

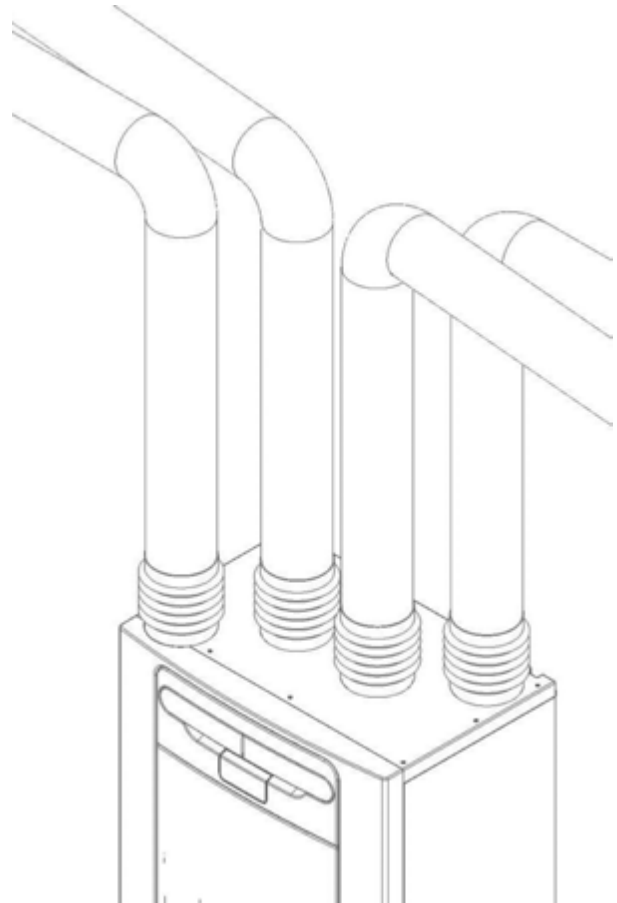

Electrical Installation



WARNING

THE ENSURE THE ELECTRICAL SUPPLY AND CONTROLS ARE ISOLATED FROM THE POWER SUPPLY BEFORE REMOVING ACCESS COVERS

Step 1: Remove the outer cover by pressing the tabs either side of the control module and lifting the cover outwards from the bottom edge.

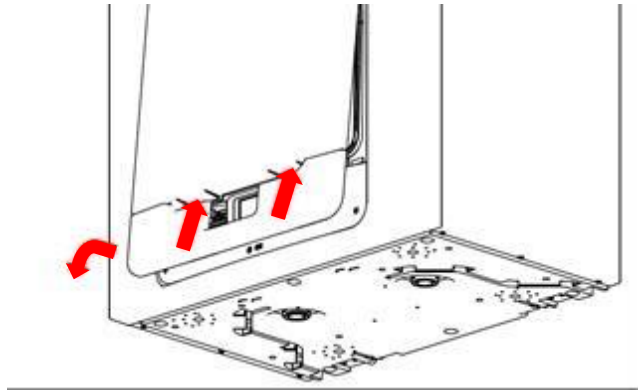

Step 2: Remove the control module by sliding it upwards and away from the unit.

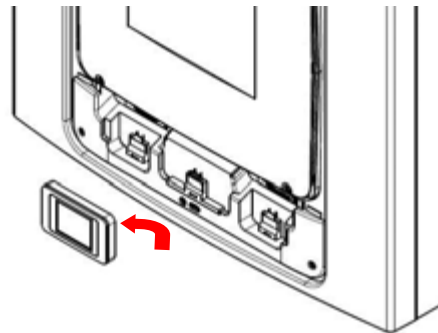

Step 3: Remove the two screws on either side of the access panel. Lift the panel outwards from the bottom edge to remove

Note: The access panel is tethered on the left hand side.

Note: All printed circuit boards are ESD sensitive. Always ensure the correct ESD protection is used (e.g. conductive wrist straps and anti-static mats.)

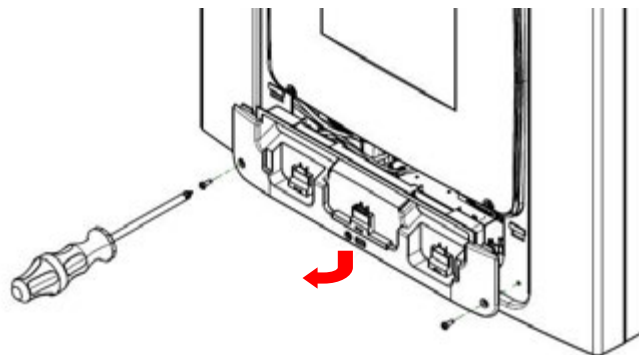

Step 4: Push the locking tab away from the printed circuit board and slide it outwards to access the terminals

Note: The printed circuit board will relock after 60mm

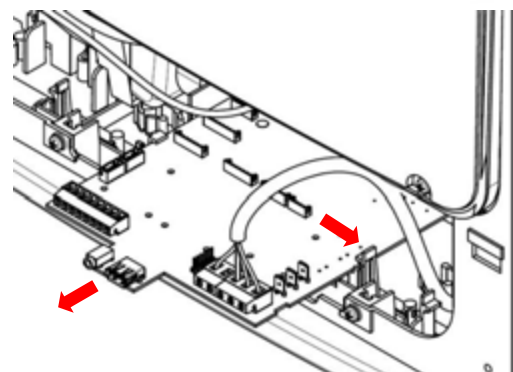

Connect Switches and Sensors

The unit can be switched to boost by applying 240V to the LS input .

Note: Alternative switches and inputs can be achieved by adding optional input accessories to the printed circuit board. See Accessories on page 42 for further details.

For good EMC engineering practice, any sensor, switched live or Volt free cables should not be installed within 50mm of other cable or on the same metal cable tray as other cables.

Connect any switches or sensors required to control the unit by connecting to the terminal connectors at the bottom of the control unit as shown on the next page in Table 1. If necessary contact your distributor regarding the wiring and fixing of accessories and sensors.

When fitting external controls, all cables should be routed through the two cable channels on the underside of the unit shown below.

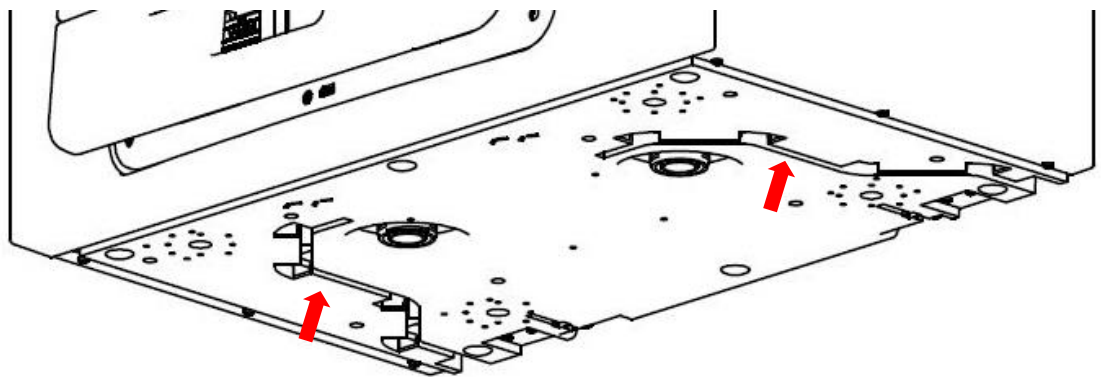
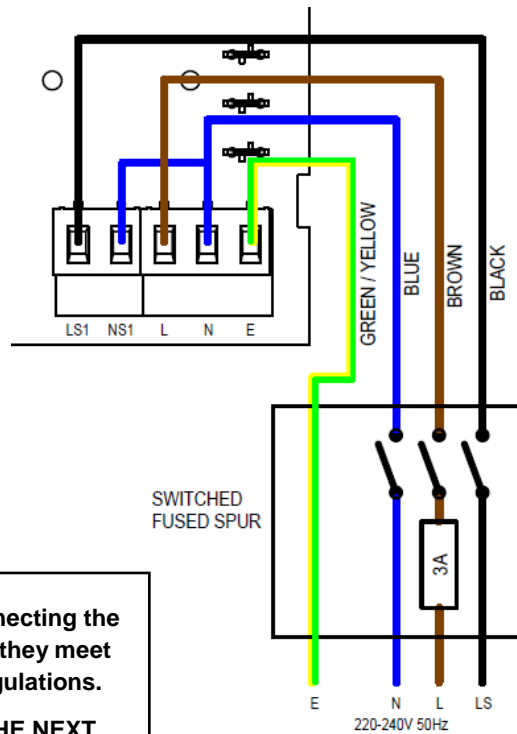

Figure 4: cable channels



Other means of connecting the unit may be used if they meet the local wiring regulations.

SEE NOTES ON THE NEXT PAGE

Terminal No.	Name	Description
REMOTE	Remote	Terminals for connecting a remote external to the unit.
SWI	Switch 1	Volt-free contact for sensor input between + and - terminals
LED	Red Light Emitting Diode Output	A 5 V LED driving signal output between the + and – terminals that enables remote indication of a unit fault. See the Control Panel for fault code (see <i>Service/Fault Code Screens</i> on page 17). May also be used for a connection to a BMS or similar.
DIAG	Diagnostic	Diagnostic port
USB	USB	Commissioning port.
LS1	Switched Live	220-240 V AC, 50 Hz input
NS1	Switched Neutral	220-240 V AC, 50 Hz input
L	Mains Live	220-240 V AC, 50 Hz input
N	Mains Neutral	220-240 V AC, 50 Hz input
⊕ EARTH	Mains Earth	Earth connector

Table 1: Terminal Connections

Connect the Power Supply



WARNINGS

1. MAINS SUPPLY VOLTAGES (220-240 V AC) ARE PRESENT IN THIS EQUIPMENT, WHICH MAY CAUSE DEATH OR SERIOUS INJURY BY ELECTRIC SHOCK. ONLY A SUITABLY QUALIFIED PERSON SHOULD CONNECT THE POWER SUPPLY TO THIS UNIT.
2. THIS UNIT MUST BE CORRECTLY EARTHED.

This unit is designed for operation from a single-phase alternating current source (220-240 VAC).

A 1.5m cable is connected internally to the unit for connection to an isolator switch.

To connect the power supply:

Ensure the local AC power supply is switched off.

One end of the power cable supplied is already connected to the unit in the manner shown above.

Connect the other end of the cable to the switched fused spur.

Use cable clamps and clips to secure the cable, as appropriate.

Connecting a Boost (Light) Switch

A Switched Live (LS1) may be used to boost the airflow when a light is turned on, for instance in a bathroom or kitchen. If the LS1 core of the mains cable is not used it should be terminated in an appropriate manner.

If the unit and the LS1 connection are on the same circuit, the jumper should be left between N and NS1 as shown above.

Connecting a Boost (Light) Switch from a different circuit

If the supply used for the Switched Live (LS) is on a different circuit to the power connections, the connections LS1 and NS1 should both be connected to the same circuit. LS1 and NS1 are connected to the unit via a built in isolator and a separate isolating relay is not needed. The factory fitted link wire should be removed.

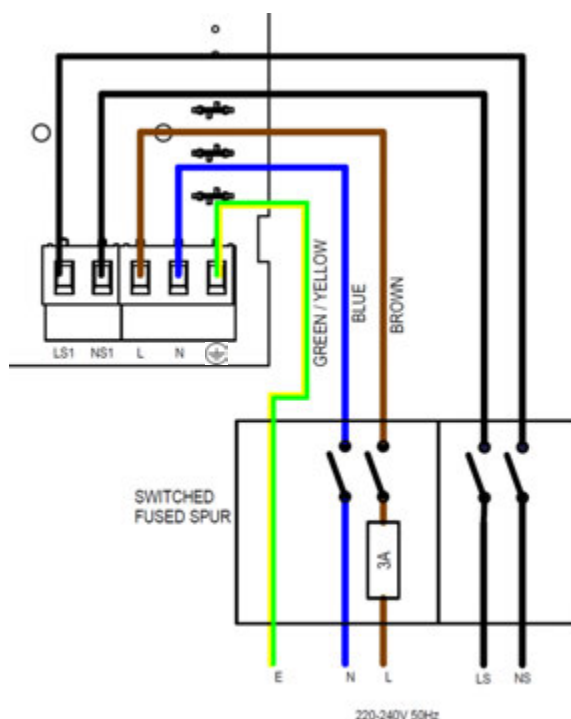

Powering up the Unit

Switching On

To switch the unit on:

1. Switch on the power at the mains supply isolator feeding the unit.
2. Following switch-on, the fan motors will start and the Control Unit will display a start-up screen, described on page 29.

N.B. If you are intending to carry out work or maintenance inside the unit, isolate the supply to the unit before removing any covers.

Switching Off

To switch the unit off:

1. Turn the power off at the mains supply isolator.

SAP Compliance

The touch-screen controller consumes 0.5W when fitted to the unit and in standby mode. The SAP PCDB results are achieved with the touch-screen controller removed from the unit. For SAP compliance, remove the controller from the unit after commissioning and store in a safe place, See page 24.

Overview







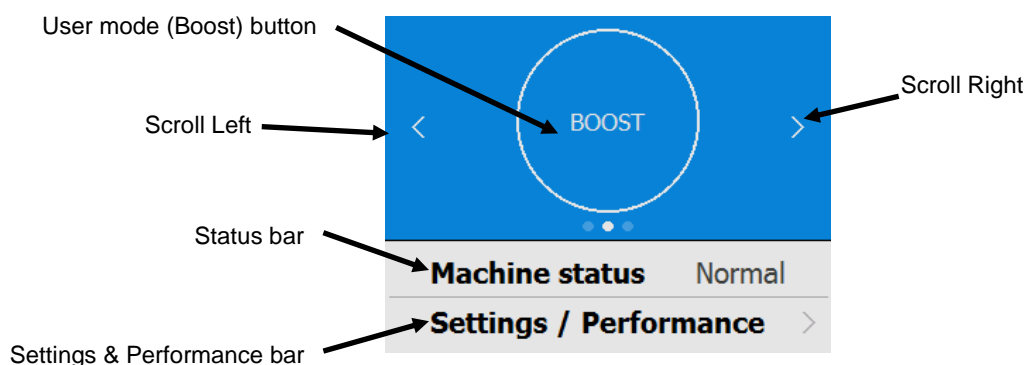

The instructions in this section are intended to provide configuration and operation information for setting up the equipment. In the event of problems, see *Diagnosing a Problem* on page 17.

Follow good practice when commissioning the unit. Ensure that the system is installed according to the system designers intent incorporating any acoustic ducting, that all joints are air tight, ducting is well supported, bends are avoided close to vents, and that the vent valves are fully open at the start of the commissioning process.

Control Unit Touch Screen Display

The touch screen display can be located on the front of the unit or connected to the unit via a remote docking kit. The Control Unit provides the user interface for commissioning and monitoring purposes. The display is a resistive touchscreen with LED backlight, which will turn off to automatically after 5 minutes to minimise power consumption. To activate the backlight, touch the display.



Navigate through the functions by pressing the      symbols, adjust settings using the   buttons. A  symbol indicates that there are further screens related to a menu option. Select the option on the touchscreen to access the related screens.

Modifying Settings

If settings need to be changed after the unit has been commissioned, access to the commissioning menu can be accessed by following the steps below.

Start up screen

Every time the unit is powered up, the start up screen appears as the software loads showing the display version.

A Quick Start sequence will appear when powering up the unit for the first time.

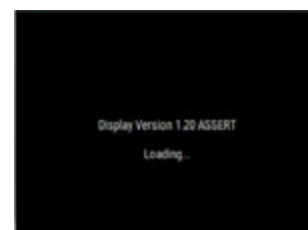



User Menu Home Screen

The user menu home screen, consists of a User Mode (LOW, BOOST, PURGE) button, a Machine status bar, and a Settings / Performance bar.

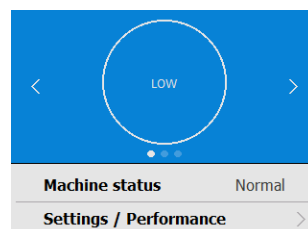

The Machine status scrolls through Mode of operation, Summer bypass status and Frost protection status.

Press **'Settings / Performance'** to access the menus.

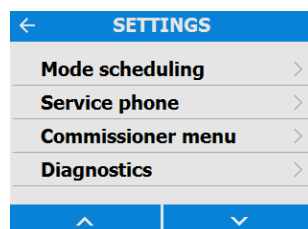

Scroll down to **'Commissioner menu'** using the   buttons at the bottom of the screen.



Enter the 4 digit lock code using the  /  buttons on the screen to access the commissioning menu. The default is 0000 and can be changed in the Modify Settings menu.

Press → to enter the commissioning menu

Press ← to return the settings menu

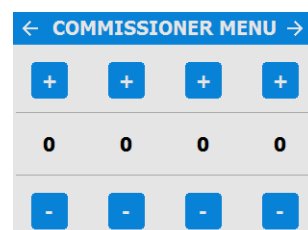

Press **'Modify settings'** to enter the commissioning screens.

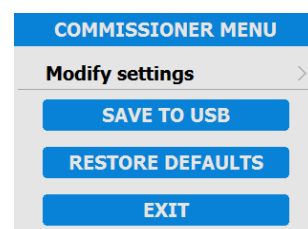

Commissioning Screens Summary

The following pages show all available settings within the commissioning menu. Please note that some settings may not be available, or may be in a different order, due to pre-configuration by your distributor. A Quick Start sequence will appear when powering up the unit for the first time.

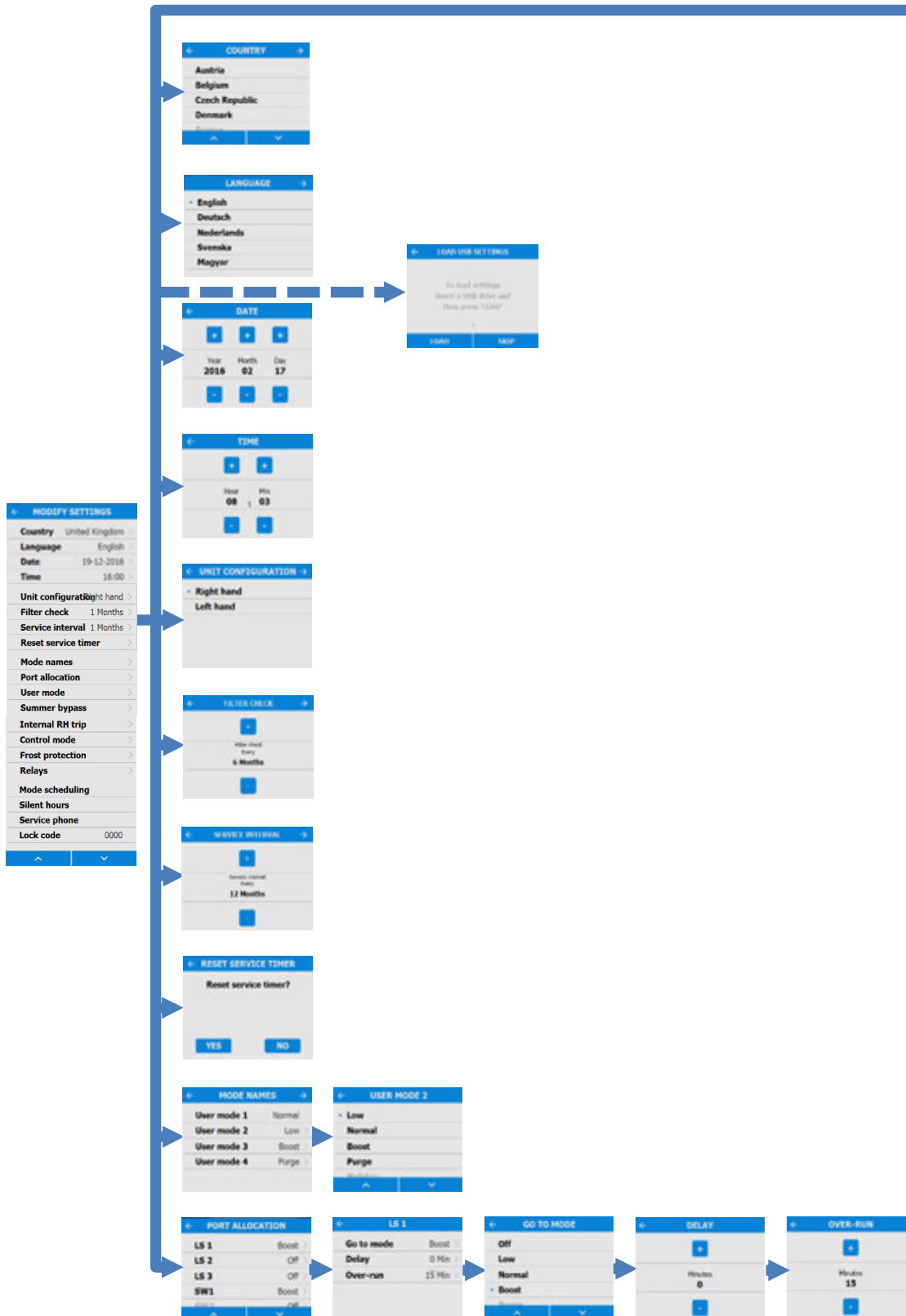

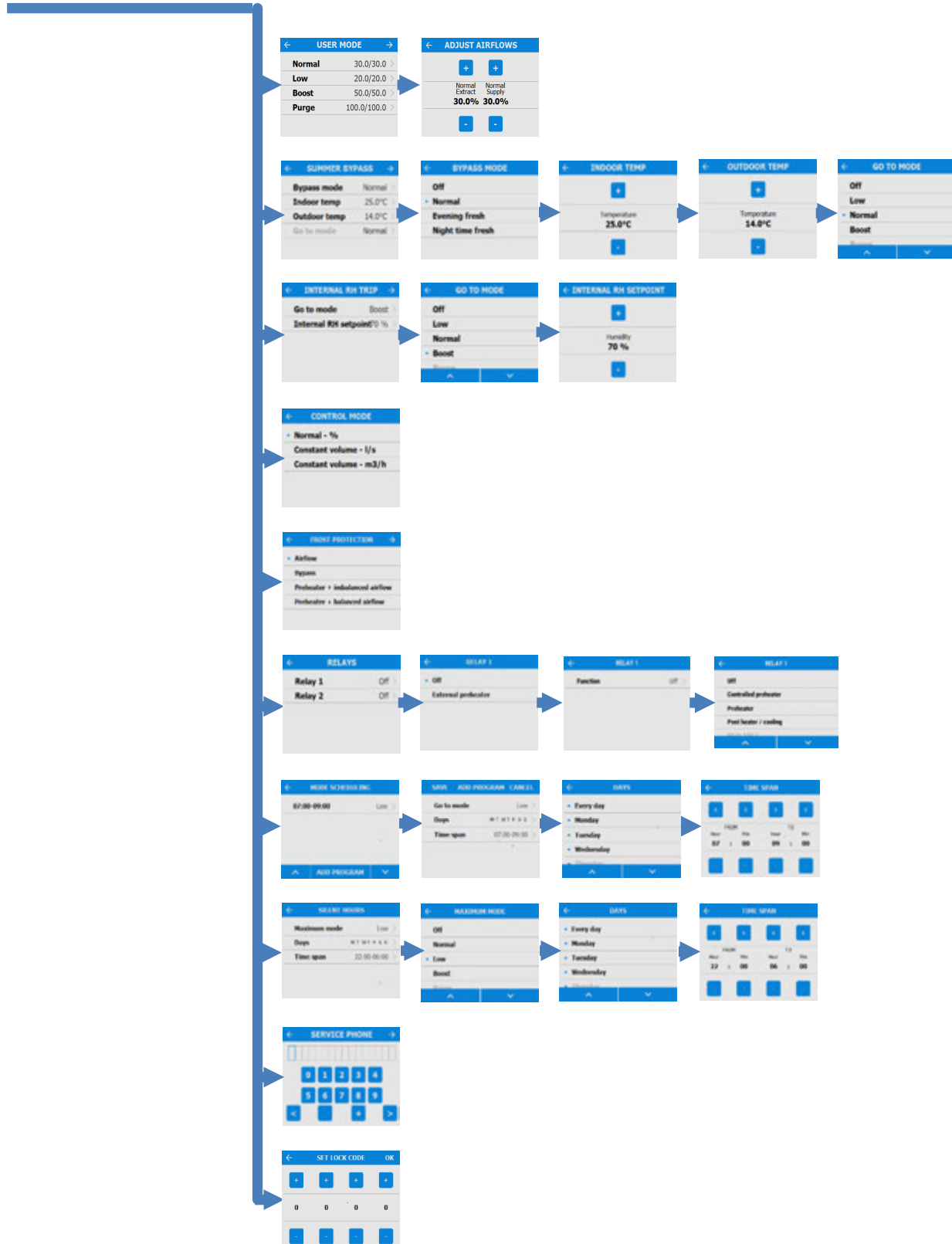

Modifying Commissioning Settings

Country

Select country – This will load any pre-determined national default parameters for all subsequent screens.

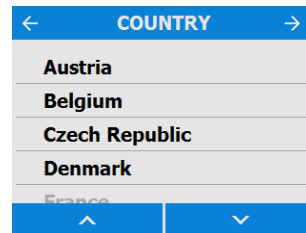

Language

Select language – The language choice does not affect the defaults setup by the country choice.



Load USB Settings

Settings can be automatically loaded to the unit via the USB port. Note: This option will only appear on the Quick Start sequence. Access to this screen can be obtained by using the Restore Defaults feature.



Date

The Date is pre-loaded as part of the factory defaults, but may be changed if required using the **+** / **-** buttons on the screen.

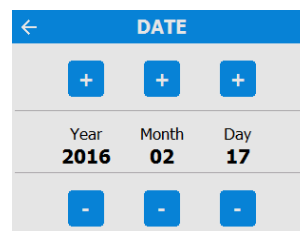

Time

The Time is pre-loaded as part of the factory defaults, but may be changed if required using the **+** / **-** buttons on the screen.

Note: The clock is 24 hour

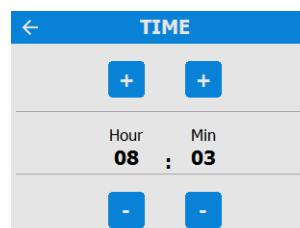

Unit configuration

Select the orientation of the unit depending on the configuration of the installation.

Units with a preheater are preconfigured from the factory and cannot be changed.

See page 18 for a description of the unit handing. Press ← to save and return to the commissioning menu.

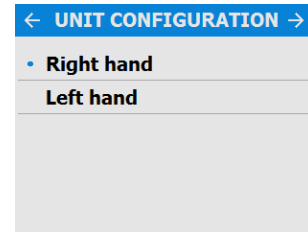

Filter Check

Select the time interval for checking the filters using the + / - buttons on the screen, between 1 month and 18 months.

Note: There is an automatic filter check notification 3 months after installation, irrespective of set intervals.

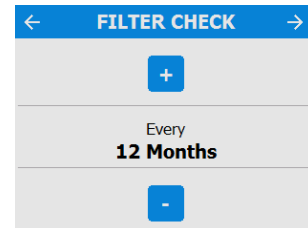

Service interval

Set the service frequency.

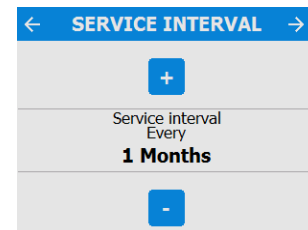

Reset Service Timer

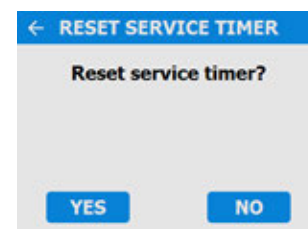

After the unit has been serviced, use this option to reset the timer.



Mode Names

The names and speed for each mode can be changed if required.

Note: The user mode 1, Normal, is not editable.

Scroll through the settings using the  &  buttons and select the mode pre-set for each User mode.



Press  to save and return to the commissioning menu.

MODE NAMES	
User mode 1	Normal
User mode 2	Low >
User mode 3	Boost >
User mode 4	Purge >

USER MODE 2	
• Low	
Normal	
Boost	
Purge	
Holiday	





User Mode

Adjust the supply and extract airflows for each mode pre-set. Select each mode to adjust to the required flow rate.

Adjust the airflows using the  /  buttons.

Press  to save and return to the commissioning menu.

USER MODE	
Normal	30.0/30.0 >
Low	20.0/20.0 >
Boost	50.0/50.0 >
Purge	100.0/100.0 >

ADJUST AIRFLOWS	
	
Normal Extract	Normal Supply
30.0%	30.0%
	

Port Allocation



The unit will automatically detect the following inputs:



- wired to the lighting
- Current sensors
- Vent-wise sensors or momentary switch



Note: Number of available ports and port types may differ from image shown depending on unit specification.

Select the Port to view the Go To Mode (speed setting), Delay and Over-run parameters.

Select the parameters to edit them.

Scroll through the settings using the  &  buttons and select the Go To mode for each Port Allocation.

Adjust the time delay for each Port Allocation using the  /  buttons. Selectable range is 0-20

Adjust the Over-Run for each Port Allocation using the  /  buttons. Selectable range is 0-30

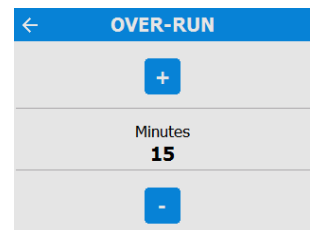
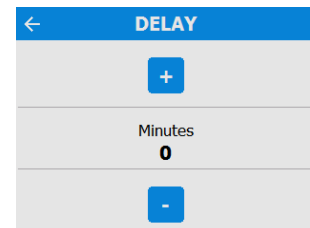
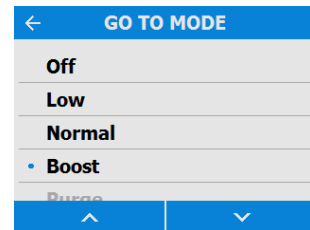
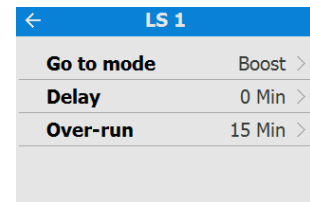
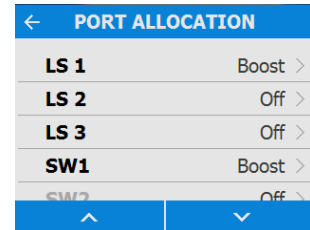



Summer Bypass



See page 59 for a full description of the Summer Bypass modes and functions

Select the required bypass mode.

The indoor temperature setting is the maximum desired room temperature. This should be set to 3° above the central heating temperature.



Change the indoor temperature using the  /  buttons on the screen.

The outdoor temperature is the minimum air temperature that the bypass will permit. This is to prevent cold draughts.

Change the indoor temperature using the  /  buttons on the screen.

This is the mode the bypass will switch to when activated.

The suggested Mode for Evening fresh and Night time fresh setting is Boost.



Scroll through the settings using the  &  buttons and select the Go To mode.

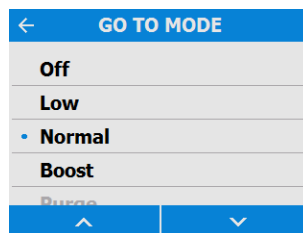
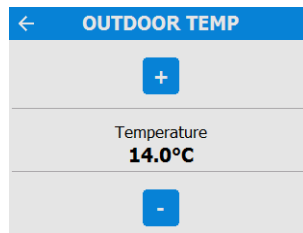
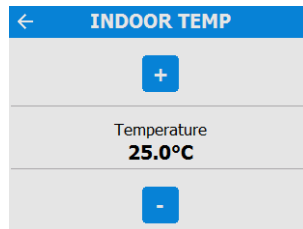
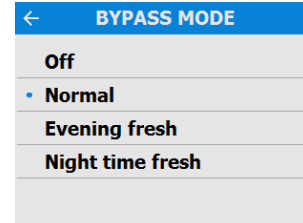
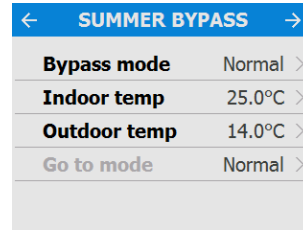

Note: Number of available modes may differ from image shown depending on bypass setting and the modes set in the commissioning process.



Internal RH Trip

The integral humidity sensor increases airflow speed in proportion to relative humidity levels. The sensor also reacts to small but rapid increases in humidity, even if the normal trigger threshold is not reached. The night time relative humidity setback feature suppresses nuisance tripping as humidity gradually increases with falling temperature.

Scroll through the settings using the  &  buttons and select the required Go To mode.

Adjust the internal Relative Humidity using the  /  buttons. Selectable range is 60% - 90%.

Internal RH sensing can be switched off by selecting "OFF", this option is above 90%, or below 60%.

Control Mode

Select whether the unit should operate in Normal or Constant Volume mode.

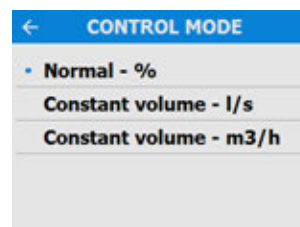
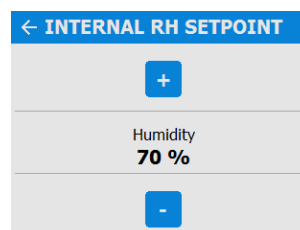
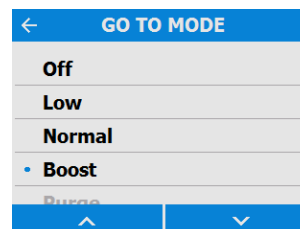
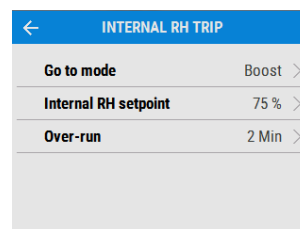

Frost Protection

Frost Protection is required to prevent condensate freezing in the heat exchanger at low temperatures. The process is fully automatic. The method used for frost protection will depend on the model and building it is installed in.

For buildings with a leak rate of 3m³/hr or less (at 50Pa), a balanced frost protection mode must be used. A balanced mode must also be used when a combustion device without a dedicated air supply is present.

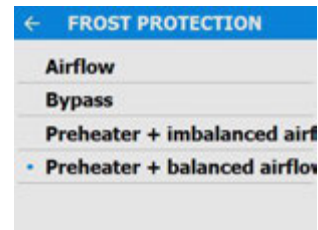

Airflow (Imbalanced)

Airflow mode reduces the Intake flow and increases the Extract flow in varying proportions dependent on the incoming air temperature. The unit will continue to recover heat as low as -20C. At this point, the unit switches to 'Extract Only' mode.

Bypass (Balanced)

Bypass mode opens the Summer Bypass and stops recovering heat until the external temperature increases sufficiently.

Airflow & Preheater (Imbalanced)

If a preheater is fitted, the preheater will turn on to warm the incoming air to above freezing. If the air temperature is so low that the heater cannot warm the air sufficiently, the supply flow rate will be reduced to compensate.

Airflow & Preheater (Balanced)

If a preheater is fitted, the preheater will turn on to warm the incoming air to above freezing. If the air temperature is so low that the heater cannot warm the air sufficiently, both the supply and extract flow rate will be reduced to compensate.

Relays



Select whether the external preheater outputs are activated. These outputs are 230V 5A maximum each.







Mode Scheduling

Use a schedule to set a Mode (Airflow setting) for a fixed, repeated period. For example, set Boost Mode every morning between 7:00am and 8:00am while cooking breakfast.

Select the Schedule to view the settings

Scroll through the settings using the  &  buttons and select the Go To mode for each Schedule.

Scroll through the days of the week using the  &  buttons and select each day to be included in the Schedule program.

Adjust the start and finish times for each day using the  /  buttons.

Silent Hours

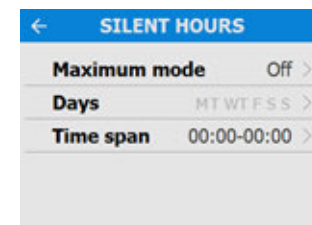
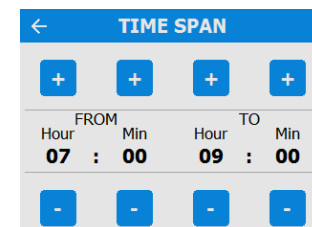
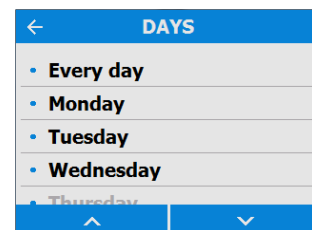
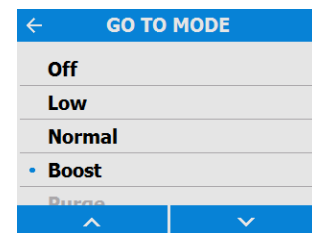
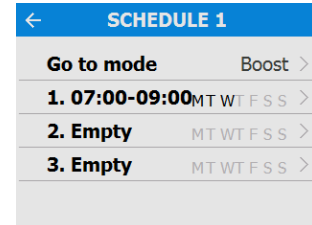
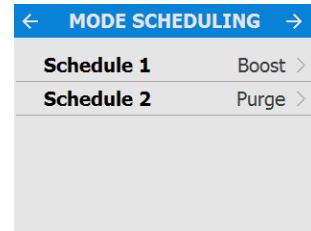

Silent Hours mode is useful to impose a speed/flow restriction on the unit to minimise unwanted noise during the night.

If Silent hours are enabled, the unit will not speed up above the set Maximum Mode. Silent Hours can be set to reoccur on specific days and times.





Service Phone

The Service Phone screen enables the installer to enter the telephone number that should be called for service in the event of a unit fault or for routine maintenance.

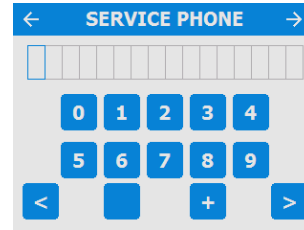
Enter the number using the buttons on the screen, Scroll through the number using the   buttons.



Set Lock Code

Set the lock code using the  /  buttons on the screen, press OK to save the code.

Note: Default code if not set at this point will be 0000.

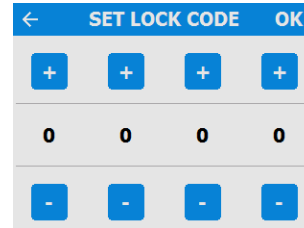

Commissioner Menu

Once the commissioning settings have been modified exit to the commissioning menu.

Settings are stored in a non-volatile memory and will be retained irrespective of mains supply breaks, however, the unit can also be restored back to factory defaults at this screen.

Press EXIT to return to the User Menu Home screen.

To complete the setup process, press the EXIT button.

If a USB device is present, the settings from the unit can be saved and used for the setup of similar units.

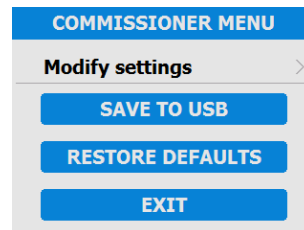

Restore Defaults

To return the unit back to factory settings press the Restore Defaults button. A confirmation screen will appear. Press YES to confirm, or CANCEL to return to the Commissioning Home screen

Once confirmed the following screen will appear, the restore process takes approximately 5 seconds. Press CANCEL to stop the restore process during this time.

Once the system has restored back to factory default settings it will go back to the start up screens.

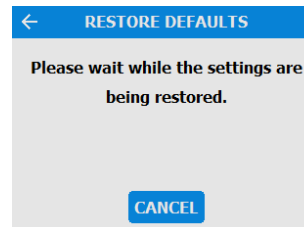

Commissioning the Unit via USB

When carrying out commissioning on multiple similar installations, commissioned settings may be downloaded and saved onto a USB at the end of the setup routine (see page 40). They can then be uploaded onto subsequent units saving time on site. The option to upload the settings is available at the beginning of the commissioning quick start menu (see page 29 & 32).

No two systems are exactly the same and the settings and flow rates at each installation should be verified.

The USB does not have to be blank however only the most recent file will be read.

Accessories

- **WiFi Controller Accessory 409195**

The WiFi controller is a plug & play accessory that fits next to the Control module. This offers the user instant access to various functions and features for direct monitoring and control of the unit using a smart phone or tablet via the Vent-Axia mobile application.

- **Ventwise PCB Accessory 472693**

The optional Ventwise controller has four inputs. These can be used for sensing temperature rise in a bath/shower hot water supply and/or current in a cooker/hob electrical circuit to activate boost, ensuring additional ventilation when needed.

- **Volt-Free Input Switch PCB Accessory 472697**

The optional Input Switch Accessory offers four volt-free pairs of switch terminals to allow boosting from manual switches or a full range of Vent-Axia controllers e.g. humidistats, PIRs and timers.

- **Switched Live expansion PCB Accessory 472699**

The optional Switched Live (LS) expansion accessory offers two extra switched live inputs (LS2 and LS3) for boosting via light switches (220-240V AC) or Normal/Boost switch. This connection has the advantage of Delay and Over-run features.

Delay enables the prevention of boost airflow between 1-20 minutes.

Over-run enables boost airflow to continue after the light switch has been turned off between 1-30 minutes

- **Analogue Input PCB Accessory 472701**

The Analogue Input Accessory has two terminals with 0-10V inputs to allow proportional 0–10V control by sophisticated controllers such as CO2 sensors and proportional humidistats.

- **Wired Remote Docking Kit Accessory 474491**

The Controller Docking Kit has been designed to allow the Controller module to be removed from the MVHR & mounted remotely to either a single or double gang flush mount back-box of 25mm depth (min). The kit is supplied with a 15m lead and control panel cover.

Further information regarding these alternative control options is available at the back of this document, Please contact your supplier for availability in your region. Some accessories may be included as standard equipment depending on unit version, please check before ordering.

WiFi Controller

The WiFi controller is a plug & play accessory that fits next to the control module. It allows the user instant access to commissioning, configuration, direct monitoring and control of the MVHR unit, using a smart phone or tablet with the Vent-Axia Connect app, available from the iTunes Store or on Google Play.



Device Compatibility

iOS

The app is compatible with the following iOS devices:

- iPhone 4s (or newer)
- iPod touch (5th generation or newer)
- iPad (3rd generation or newer)
- iPad mini
- iPad air

Android

The app is compatible with most Android devices equipped with Bluetooth 4.0 and running Android 4.3 (Jelly Bean) or later.

Installation

Installation must be carried out by a competent person.

Installation may be carried out without removing power from the unit, provided **no screws are removed**.

Step 1: Remove the outer cover by pressing the tabs either side of the control module and lifting the cover outwards from the bottom edge.

Step 2: Insert WiFi module into slot to the left of the touchscreen control module.

Step 3: The WiFi controller status LED illuminates when the module is fitted correctly.

Step 4: Connect phone or tablet device to WiFi network using the AP SSID (network name) indicated on the WiFi controller. Status LED will indicate **green** when connected.

Step 5: Use the app to connect to the unit, either using the phone camera, or entering the device name and security key indicated on the WiFi controller label.

Step 6: Replace outer cover.

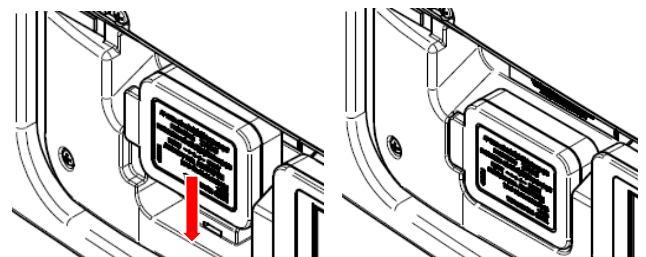
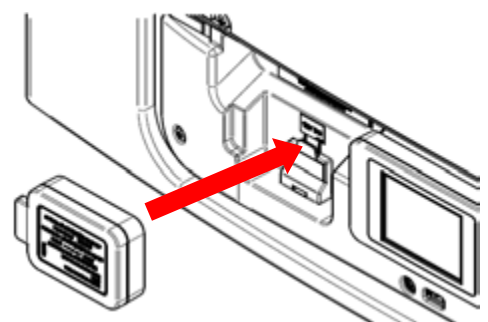
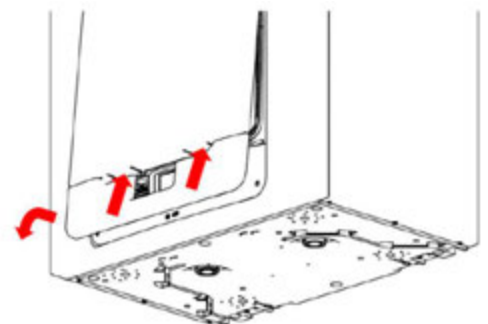

Understanding the product label

AP SSID

The name of the wireless network hosted by the WiFi controller when it is not configured to communicate online.

DEVICE ID

The name the WiFi module identifies as when selecting a device to configure from the App.

SECURITY KEY

The pass-phrase required to enable secure communications with WiFi controller, required when adding the device to the app.

RESET BUTTON

A reset button is hidden behind this area of the label.

STATUS LED

A tri-colour LED is placed behind this area of the label, indicating the status of the WiFi controller.

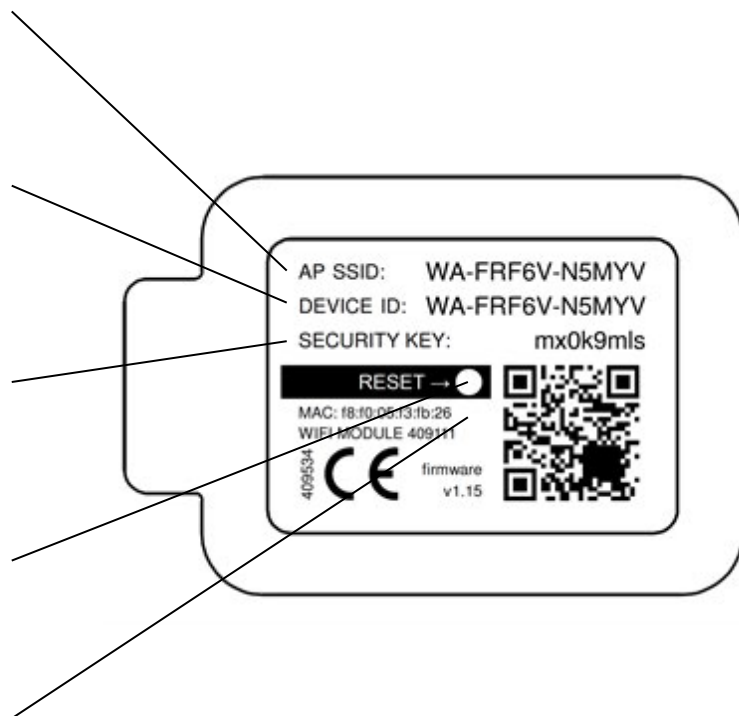

Resetting the WiFi Controller

A reset button is provided behind the label on the front of the WiFi Controller. It may be accessed by piercing the label with a small screwdriver in the position indicated on the label.

Short Press (< 5 seconds)

A press less than 5 seconds shall toggle the WiFi controller between 'Temporary AP' and 'WLAN' modes (if the unit is configured for WLAN access). Use this if the WiFi status indicates 'WiFi error' to correct network settings.

Long Press (\geq 5 seconds) - Reset to factory defaults

A press longer than 5 seconds shall put the WiFi controller into 'reset confirm' state, with a fast red LED flash. To confirm the intent to reset to factory defaults, press and hold the reset button for a further 5 seconds. The LED will change to solid red to confirm it is resetting and will reboot when the button is released.

Supported Networks

The WiFi controller supports IEEE 802.11 b/g/n networks at 2.4GHz using the following network security:

- Open
- WEP
- WPA
- WPA2

Troubleshooting

LED Status	Description	Actions
Solid blue	Initialising	None - normal operation
Slow blue flash	Connecting to a wireless network	
Solid green	Connected to a wireless network	
Fast green flash	Active communication with a connected network	
Solid yellow	WiFi controller is hosting a temporary network, without a device currently connected	Connect phone or tablet to the AP SSID (network name) indicated on the WiFi controller
Fast yellow flash	Active communication & weak signal	Move existing or introduce additional WiFi access point closer to the MVHR unit.
Slow red flash	WiFi error (e.g. cannot connect to network)	Configure WiFi controller in temporary access point mode (see previous page) and correct network settings
Fast red flash	Factory defaults reset confirm	See previous page regarding resetting the WiFi controller
Solid Light Blue	Bootloader mode <i>Should not appear in normal operation</i>	Isolate power to the MVHR unit, wait 30 seconds and re-power the MVHR. If this fault persists, contact your distributor support for further assistance.
Solid Purple	Network controller update mode <i>Should not appear in normal operation</i>	
Solid Red	Communications fault between mainboard and WiFi controller	
Slow Flash - Red / Green	Internal fault on WiFi controller	

Ventwise Accessory



WARNING

THE FAN AND ANCILLARY CONTROL EQUIPMENT MUST BE ISOLATED FROM THE POWER SUPPLY DURING ANY MAINTENANCE AND WHEN FITTING THIS CONTROL MODULE

Vent Wise Accessory controls the unit by the choice of either or both current and temperature sensors, which detect when a cooker, shower are in use. The unit (**Vent Wise Accessory**) has four input for the sensors. Setup of these sensors is done in the Kinetic advance controller in the commissioning menu.

For electric showers and cookers a current sensor is used to detect current flow.

For conventional showers (fed from a hot water system) a temperature sensor is used to detect the presence of hot water in the hot water pipe to the shower.

Both current and temperature sensors are available with cable lengths as follows: 4, 6 and 12 metre lengths.

Installation

1. Access the main printed circuit board following the electrical installation instruction in the “Installation & Commissioning” section of this document.

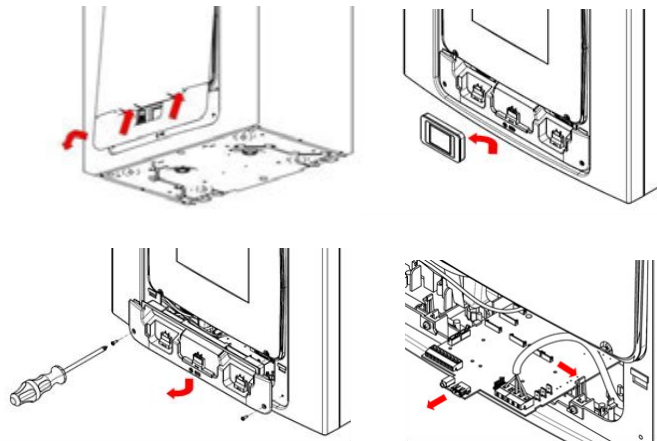

2. Fit the three plastic stand-offs provided, into the three holes in the Input Switch PCB.

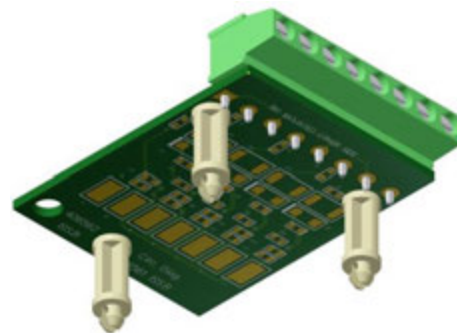

3. Fit the Input switch PCB to the main PCB in position shown.

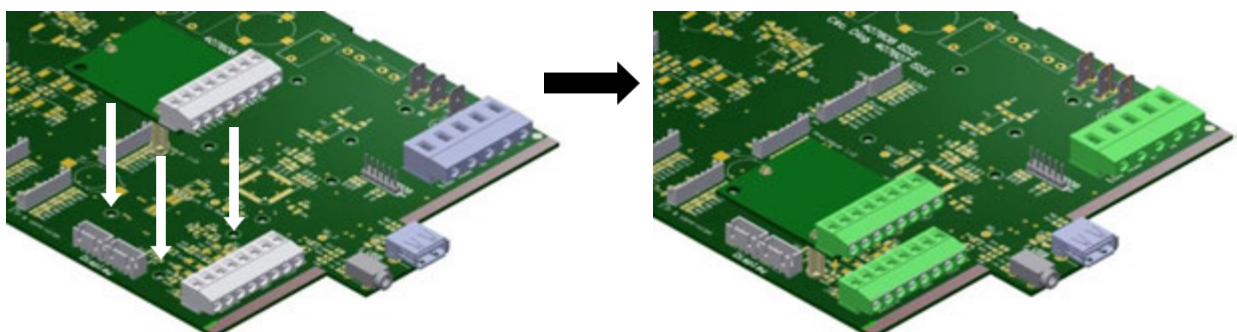

4. Connected the lead from the Vent Wise board into the socket shown above marked "I/O & Vent Wise"

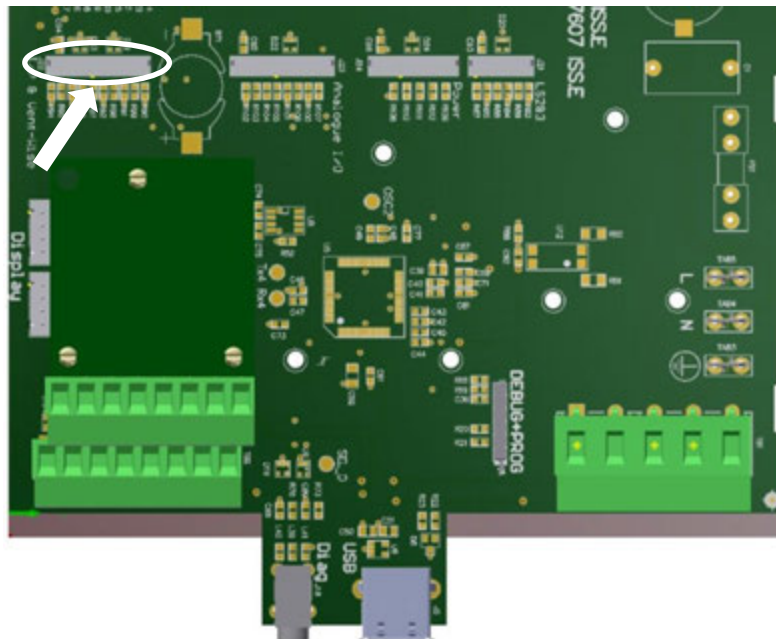

Current Sensing (For Cookers)

5a. Ensure the power is isolated. Decide upon the best possible position to mount the sensor. Disconnect the live conductor and carefully thread the sensor over. Slide the sensor over the conductor to a position where it will not be trapped. Reconnect the live conductor.

Current Sensing (For Showers)

5b. Find a suitable position to fit the current sensor, this could be in a local isolator, at the distribution board or inside the shower unit. Once the position has been determined, ensure the power is isolated. Disconnect the live conductor and carefully thread the sensor over. Slide the sensor over the conductor to a position where it will not be trapped. Reconnect the live conductor.

6. From wherever the sensor is fitted, find a suitable route to run the sensor control wiring to the MVHR unit. For sensor entry to the MVHR unit see page 25. If the sensor is fitted in a shower unit **ensure that you do not damage the waterproof integrity in any way.**

At all times ensure the wire does not get damaged by trapping of the cable when re-instating casings or covers to isolators.

7. Wire the cable into the terminals as indicated in the wiring diagrams Fig 1.

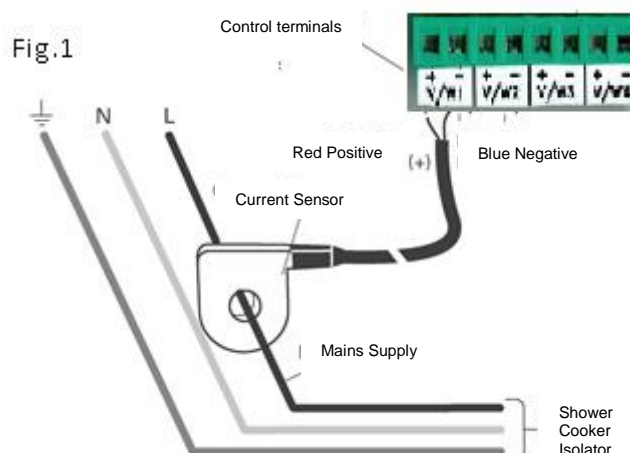

Temperature Sensing

8. Where used for temperature sensing to a normal shower, the sensor must be fitted to the hot water feed pipe on the shower mixer. Find a position, on the pipework which must be uninsulated copper. Remove any paint or corrosion from the pipe, apply thermal grease to the flat part of the sensor then firmly secure the sensor to the pipe using the clip provided. It is most important that good thermal conductivity is obtained. (See fig. 2 below).

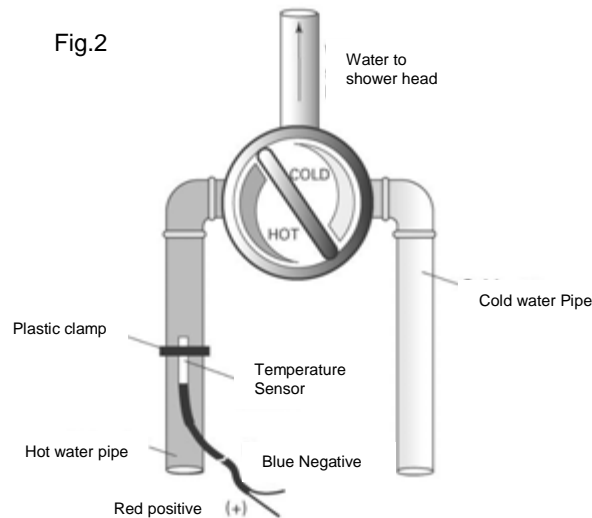

9. From wherever the sensor is fitted, find a suitable route to run the sensor control wiring to the MVHR unit. For sensor entry to the unit see page 25. At all times ensure the wire does not get damaged by trapping of the cable.

10. Wire the cable into the terminals as indicated in the diagrams Fig 1.

11. Before fitting the covers to the MVHR unit note which terminals have been used on the Vent Wise board for each sensor.

12. Replace the covers on the MVHR unit and turn it on.

13. For the current sensing turn on the breaker and the cooker/shower isolating switch.

14. Turn on the cooker/shower to low power and the machine status should change from Normal to Vent-Wise after five seconds. If not the load pot needs adjusting.

15. Adjust the load pot if necessary, this is done in the Commissioner menu by selecting port allocation, and then select Vent-Wise, this gives access to set each of the four inputs. Select the input sensor. At this point load pot or time pot can be selected. Select the load pot, this can be adjusted between 5% & 95% by the + & - buttons, adjust so the unit goes to boost when cooker/shower is used.

16. Now select the time pot and adjust time by the + & - buttons. It has a range of 1 to 25 minutes, for optimum performance and energy conservation a 20 minute overrun time is probably the best starting point. **N.B. the overrun time serves two functions: the first to ensure the fan does not cycle with the cooker/ shower thermostat. Second to clear residual steam and condensation following and after showering has finished.**

17. For the Temperature Sensing (shower).

18. Turn on the shower, wait 30 seconds after the hot water is being delivered, the unit status should change from Normal to Vent-Wise, if it does not the load pot needs adjusting.

19. Adjust the load pot if necessary, this is done in the Commissioner menu by selecting port allocation, and then select Vent-Wise this gives access to set each of the four inputs. Select the input the sensor. At this point load pot or time pot can be selected. Select the load pot, this can be adjusted between 5% & 95% by the + & - buttons, adjust so the unit goes to boost when shower is used. Do not adjust the pot below the 50% position as this can cause nuisance triggering. If a lower setting is needed first check that the temperature of the hot water is above 60oC as this should be to kill off legionella, if it is at this temperature then the integrity of the conduction of heat from the pipe to the sensor should be carefully checked.

20. Now select the time pot and adjust time by the + & - buttons. It has a range of 1 to 25 minutes, for optimum performance and energy conservation; a 20 minute overrun time is probably the best starting point. N.B. the overrun time should be set to ensure the fan clears all residual steam and condensation after showering has finished.

Special Notes regarding Temperature Sensing

- a) There will be an inevitable delay between hot water being delivered at point of use and the controller sensing the temperature, this is due to the time taken by the conduction of heat from the water through to the outside of the pipe and then to the clamp on sensor. This time delay will vary with ambient conditions, hot water temperature and pipe wall thickness. It is most important therefore that great care is taken when fixing the sensor to maximise the heat conduction process. Please pay particular attention to cleaning the pipe, applying the thermal grease and clamping the sensor.
- b) Similarly there will be a delay in the unit turning off the fan as it will take time for the dead leg to lose heat, again this will vary with ambient conditions, hot water temperature and pipe wall thickness. The time of this natural cooling process should be taken account of when setting the run on timer. As a guide, at an ambient temperature of 21oC and a hot water temperature of 50oC. The cooling down process will be 5 – 10 minutes and this should be taken into account when setting the overrun timer.
- c) The temperature sensor must be fitted to the copper pipe. With plastic plumbing systems a section of copper pipe must therefore be installed to receive the sensor.

Input Switch Accessory



WARNING

THE FAN AND ANCILLARY CONTROL EQUIPMENT MUST BE ISOLATED FROM THE POWER SUPPLY DURING ANY MAINTENANCE AND WHEN FITTING THIS CONTROL MODULE.

The volt free Input Switch accessory board has four inputs for volt free contacts, allowing up to four independent switched inputs to be used.

Installation

1. Access the main printed circuit board following the electrical installation instruction in the “Installation & Commissioning” sections of this document.

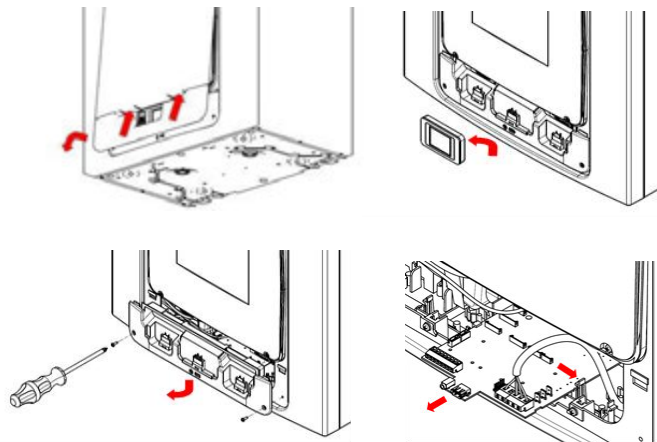

2. Fit the three plastic stand-offs provided, into the three holes in the Input Switch PCB.

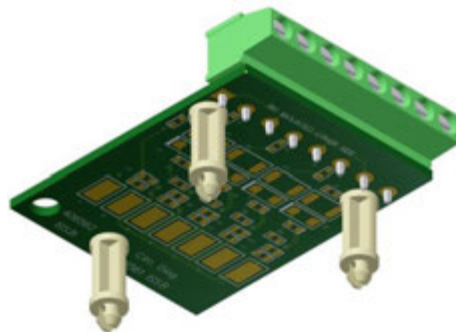

3. Fit the Input switch PCB to the main PCB in position shown.

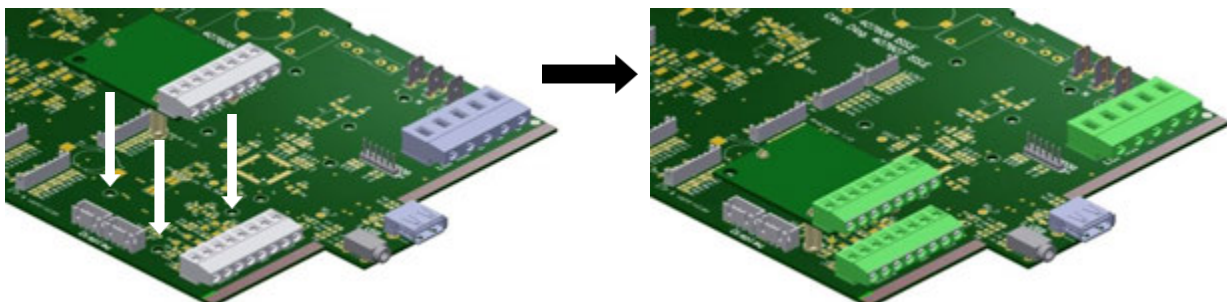

4. Connect the lead from Input Switch PCB into the socket on the left hand side of the PCB marked "I/P VentWise".

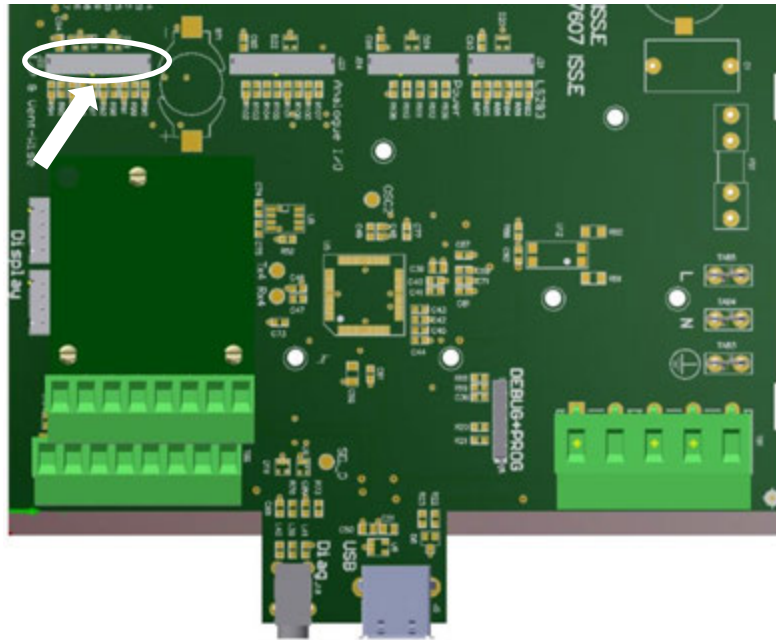

5. For cable routing from the switches into the unit, refer to the electrical installation instruction on page 25.
6. Connect the lead from each switch into the terminal block, one wire in the + and the other in the -.
7. Before fitting the covers, note which terminals have been used.
8. Replace the covers and turn it on.
9. Activate each switch input in turn to ensure functionality.
10. To adjust the speed for each input refer to the Installation & Commissioning sections of this document and go to the commissioning menu and follow the steps to change speeds.

Switched Live Expansion PCB Accessory



WARNING

THE FAN AND ANCILLARY CONTROL EQUIPMENT MUST BE ISOLATED FROM THE POWER SUPPLY DURING ANY MAINTENANCE AND WHEN FITTING THIS CONTROL MODULE.

The LS2/3 accessory board has two independent LS (Switched live) inputs which can be connected to switches on different circuits to the power circuit of the MVHR unit.

Installation.

1. Access the main printed circuit board following the electrical installation instruction in the “Installation & Commissioning” sections of this document.

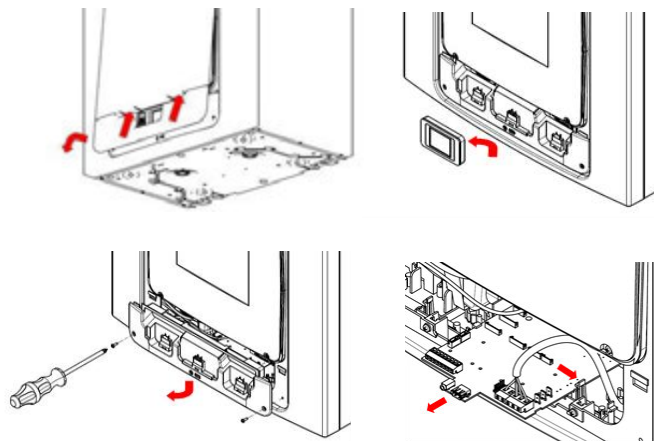

2. Fit the three plastic stand-offs provided into the three holes in the LS2/3 PCB.

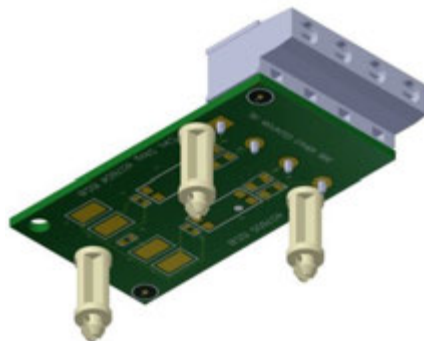

3. Fit the LS2/3 PCB to the main PCB in position shown.

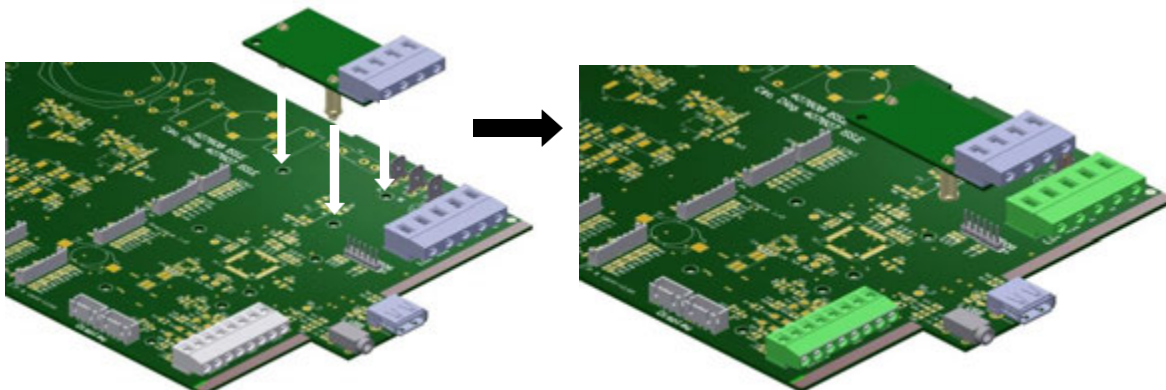

4. Connect the lead from LS2/3 PCB into the socket J21 shown below.

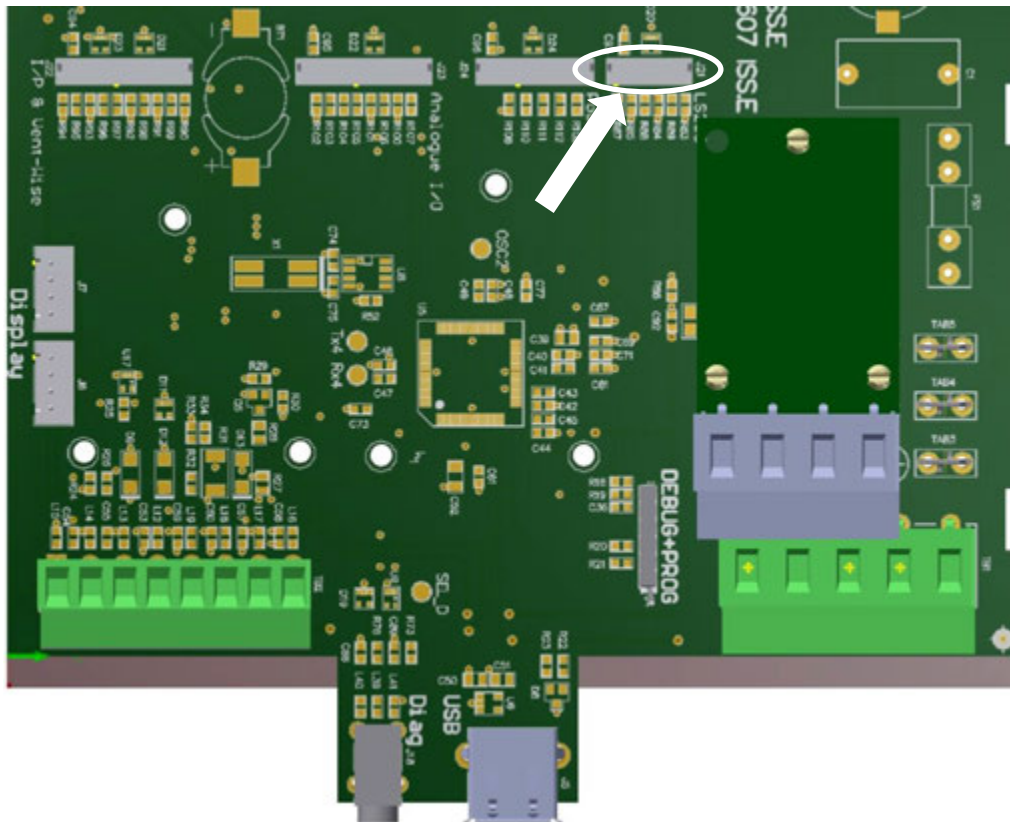

5. For routing the wires into the unit reference the electrical installation instruction on page 25.
6. From the required circuit, take the switched live and the neutral. Connect the switched live wire to the terminal marked LS2 and the neutral wire to the terminal marked NS2. For additional circuit use terminals LS3 and NS3.
7. Replace the covers and turn it on.
8. The LS2 & 3 input can be set up with delay on, over run and boost speed, refer to the Installation & Commissioning sections of this document to change settings.
9. After set up, test the LS input functions as required.

Analogue Input PCB Accessory



WARNING

THE FAN AND ANCILLARY CONTROL EQUIPMENT MUST BE ISOLATED FROM THE POWER SUPPLY DURING ANY MAINTENANCE AND WHEN FITTING THIS CONTROL MODULE.

The analogue input (I/O) PCB accessory has two 0-10V inputs for proportional sensors, and two 0-10V outputs for proportional dampers. Note: The proportional sensors and dampers require their own power supply.

Installation.

1. Access the main printed circuit board following the electrical installation instruction in the “Installation & Commissioning” sections of this document.

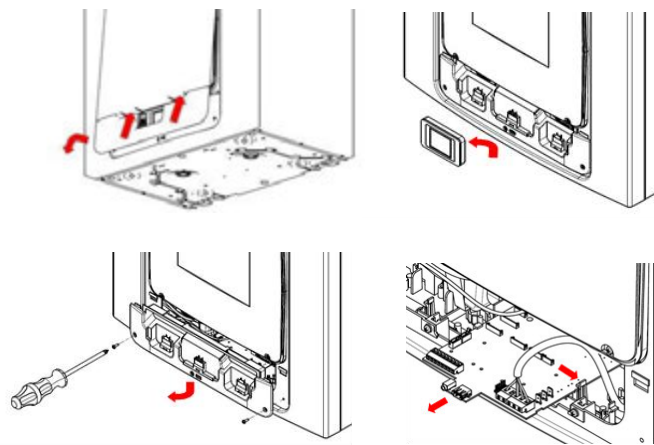

2. Fit the three plastic stand-offs provided into the three holes in the Analogue input PCB.



3. Fit the Analogue input PCB to the Main PCB in position shown.

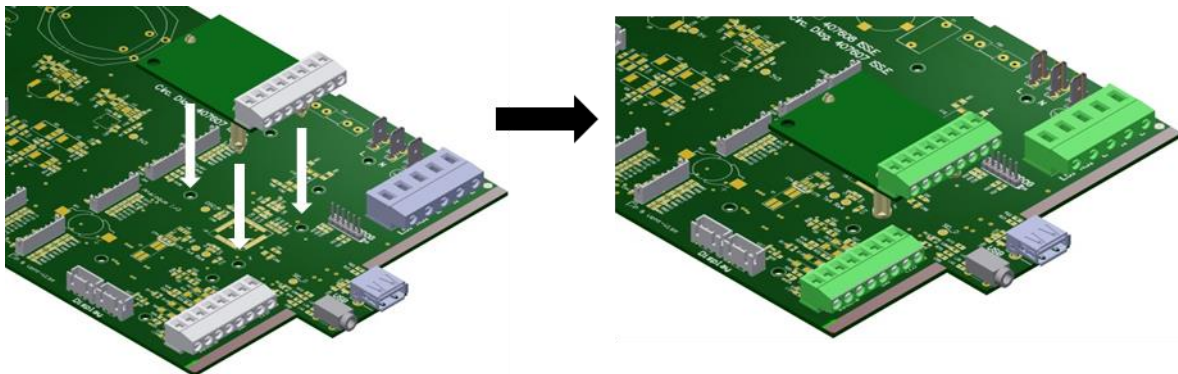

4. Connect the lead from Analogue I/O PCB into the socket marked "Analogue I/O" shown below.

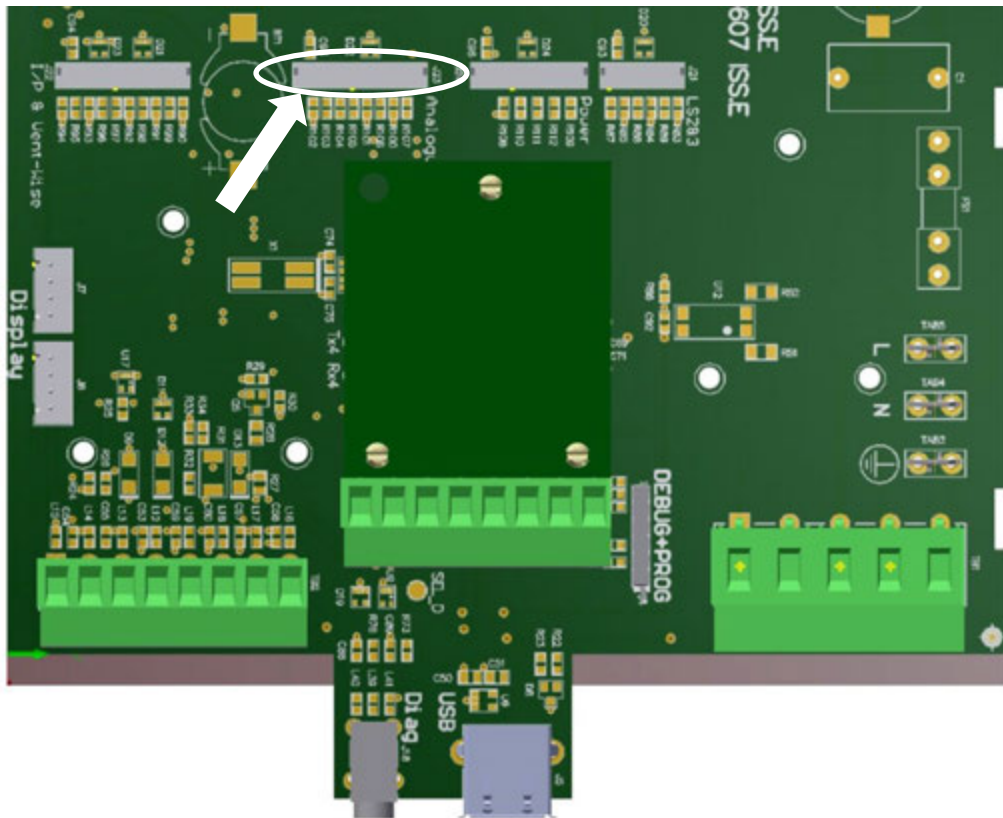

5. For routing the sensor leads into the unit, reference the electrical installation instruction on page 25.
6. For the siting of the Temperature, Humidity and CO2 proportional sensors refer to their instructions.
7. For connecting proportional sensors, connect the ground (0V) from the sensor to the terminal P1- of Analogue board and the 0–10V signal from sensor to the terminal P1+ of Analogue board. For additional sensor repeat above using P2 terminal.
8. For the siting of the proportional dampers refer to their instructions.
9. For connecting proportional dampers, connect the ground (0V) from the damper to the terminal V1- of Analogue board and the 0–10V signal input from damper to the terminal V1+ of Analogue board. For additional sensor repeat above using V2 terminal.
10. To set up the speed, type and operating range, refer to the Installation & Commissioning sections of this document to change settings.
11. After set up, test the inputs and outputs function as required.

Wired Remote docking Kit Accessory



WARNING

THE FAN AND ANCILLARY CONTROL EQUIPMENT MUST BE ISOLATED FROM THE POWER SUPPLY DURING ANY MAINTENANCE AND WHEN FITTING THIS CONTROL MODULE.

The Wired Controller Docking Kit is designed so that the Control Module on the MVHR unit can be mounted remotely. The Docking module is designed to fit a single or double gang flush mounting back box with a min. depth of 25mm.

The Kit contains the 1 x Docking module, 1 x 15m connection cable, 1 x blank cover and mounting screws.

Installation.

1. The main printed circuit board following the electrical installation instruction in the Installation & Commissioning sections of this document.
2. Site the Docking module at a height of 1.5m from the floor and within the distance of a 15m cable run from the kinetic Advance unit. Do not extend the cable provided.
3. Fit the Connection cable provided into the back box, feed the cable through to the MVHR unit with the plug in terminal connector end at the back box. Avoid routing cable alongside mains power cable.
4. To fit the Docking module to the back box, first remove the two screws, one either side. (1) Slide the front fascia then press the two tabs at the bottom. (2) This will release the 2 clips that are retaining the front fascia. You can now slide up the fascia as far as it will go and lift it off the back section. (3) Fit the cable connector to the socket on the back section. Fit the back section to the back box by using two screws supplied with the back box. (4) Refit front fascia in reverse order of its removal.

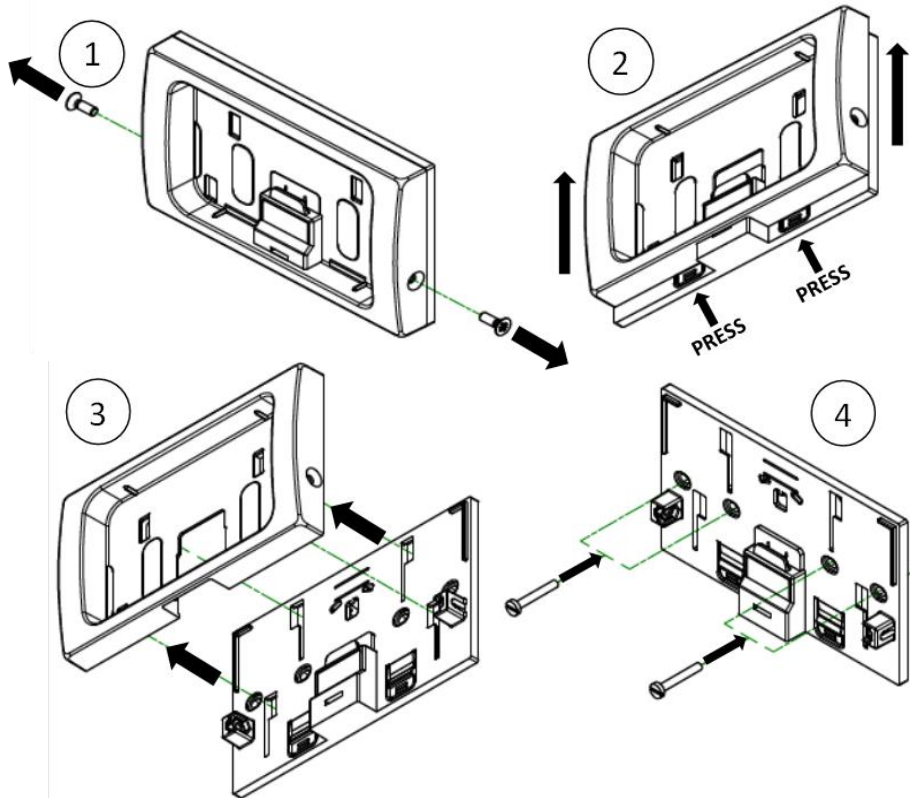

5. For routing the cable from the Docking module into the Kinetic Advance, reference the electrical installation instruction in the "Installation & Commissioning" document supplied with your unit. The cable should be routed in on the left hand side of unit.
6. The cable is connected to the terminal block TB2 EXTERNAL REMOTE/LED/SW1 at A, B, C and D terminals. The cable has one of two wire colour codes and should be connected in the order shown in the table below. (5).

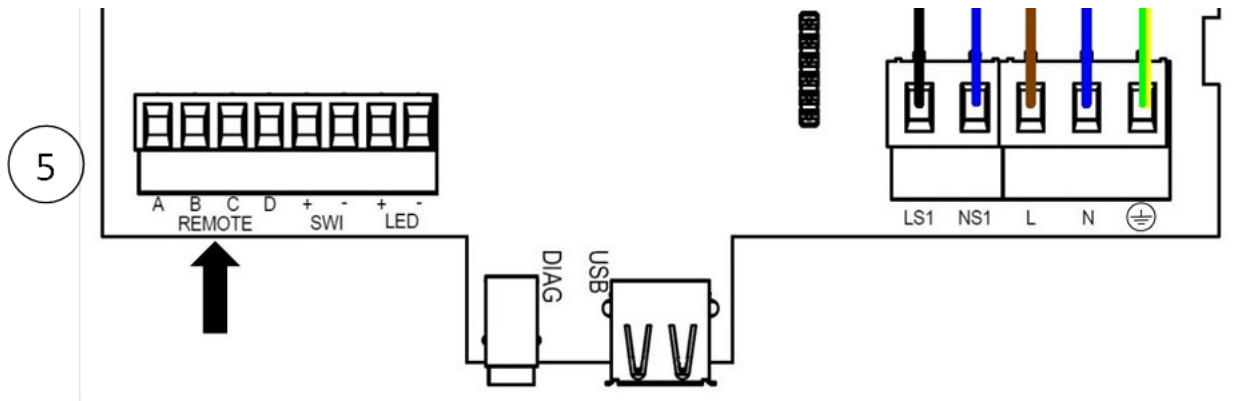

Terminal ref - A	Black	Black
Terminal ref - B	White	Orange
Terminal ref - C	Green	Brown
Terminal ref - D	Red	Red

7. To remove the display controller from the unit push up the units front panel. This will give you access to the controller. Remove the controller and replace it with the blanking cover provided.
8. Refit the front panel on the unit.
9. To fit the display controller to the docking module first ensure that the two side screws are removed. Push the front fascia up until it stops. Insert the display controller module into the docking module.(6) Push down the front fascia to engage the display controller module with the contacts.(7) Refit both side screws (8).
10. Turn on the the unit and check that the controller works.

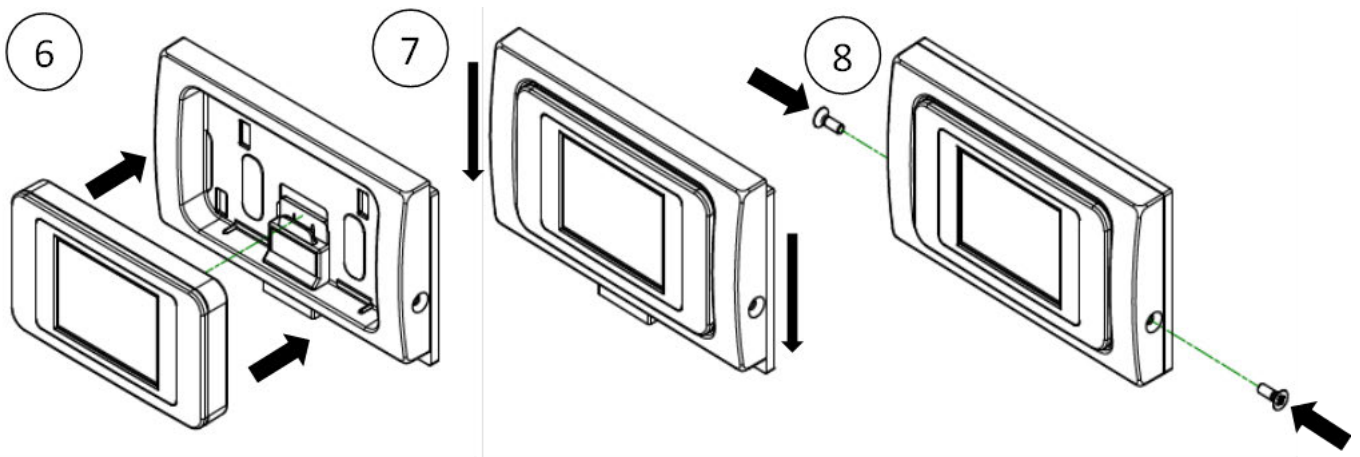

Flow Rate settings

The Sentinel Kinetic Advance has four (4) user defined speeds in addition to the non-adjustable Maximum speed.

User defined speeds can be assigned a Mode name from the list below. (some options may not be available in your region)

- | | |
|--|-----------------|
| - Low | - Night time |
| - Normal (Unit default operating mode) | - Party |
| - Boost | - Unoccupied |
| - Purge | - Over pressure |
| - Holiday | - Fireplace |

Note: The flow rate for each mode is set independently and not defined by the mode name.

When setting up Over Pressure or Fireplace Mode, the supply rate must be set higher than extract rate. This is to provide a positive internal pressure in the dwelling to assist with the initial expulsion of combustion products from the fireplace via the flue.

Fireplace mode does not prevent under-pressure

Mechanical Ventilation with Heat Recovery (MVHR) systems are not designed to provide combustion air.

NOTE: It is the responsibility of the open-flued appliance installer to ensure conformance with the current local building regulations for fuel burning appliances.

Frost Protection

Frost Protection is required to prevent condensate freezing in the heat exchanger at low temperatures. The process is fully automatic. The method used for frost protection will depend on the model and building it is installed in.

For buildings with a leak rate of 3m³/hr or less (at 50Pa), a balanced frost protection mode must be used. A balanced mode must also be used when a combustion device without a dedicated air supply is present.

Airflow (Imbalanced)

Airflow mode reduces the Intake flow and increases the Extract flow in varying proportions dependent on the incoming air temperature. The unit will continue to recover heat as low as -20C. At this point, the unit switches to 'Extract Only' mode.

Bypass (Balanced)

Bypass mode opens the Summer Bypass and stops recovering heat until the external temperature increases sufficiently.

Airflow & Preheater (Imbalanced)

If a preheater is fitted, the preheater will turn on to warm the incoming air to above freezing. If the air temperature is so low that the heater cannot warm the air sufficiently, the supply flow rate will be reduced to compensate.

Airflow & Preheater (Balanced)

If a preheater is fitted, the preheater will turn on to warm the incoming air to above freezing. If the air temperature is so low that the heater cannot warm the air sufficiently, both the supply and extract flow rate will be reduced to compensate.

Summer Bypass Mode

The Sentinel Kinetic Advance includes a Summer Bypass (SBP) feature to bypass the heat exchanger to provide cooling when the desired Indoor Temperature is above the ambient temperature.

Note that the volume of air provided by a ventilation system is a fraction of that required for space heating or space cooling and will not in itself be sufficient to cool a room. It will however, provide a contribution.

Modes of operation

Bypass Mode	Operation
Off	Bypass feature is disabled
Normal	The unit will run on Normal Mode, unless cancelled
Evening Fresh	The unit will run on the user selected Mode for 5-hours before reverting to Normal, unless cancelled
Night Time Fresh*	The unit will run at the user selected Mode, unless cancelled

Bypass mode will operate when both the Indoor and Outdoor temperature thresholds are exceeded, and the outdoor temperature is below the indoor temperature.

Indoor Temp: This is the maximum desired indoor temperature. Above the set indoor temperature the summer bypass will operate.

Indoor temp should be set, 2-3°C higher than the central heating thermostat to prevent the bypass operating in winter, and 2-3°C lower than any air conditioning thermostat if fitted.

Outdoor Temp: This is the minimum allowed outdoor air temperature. The air temperature must be above this value for the Bypass to operate, use this value to prevent the bypass operating in winter.

The suggested Outdoor Temp, is 14°C, set as appropriate for your region.

Bypass mode will be cancelled when either:

- The internal air temperature drops below the Indoor Temp threshold, or
- The external air temperature drops below the Outdoor Temp threshold

Note: Pressing the Boost button during Evening Fresh and Night Time fresh operation will revert the unit to Normal bypass mode.

It is recommended that the user selected mode chosen for Evening Fresh and Night Time Fresh is higher than Normal flow rate to reduce the indoor temperature more rapidly.

*Night Time Fresh Mode is intended for use through the night when cooling is a higher priority than any increase of noise. Note, that the air noise in your system is influenced by flowrate, ducting design, layout and the size and type of vents used in the rooms. If improvements are required please contact your installer.

Product Dimensions

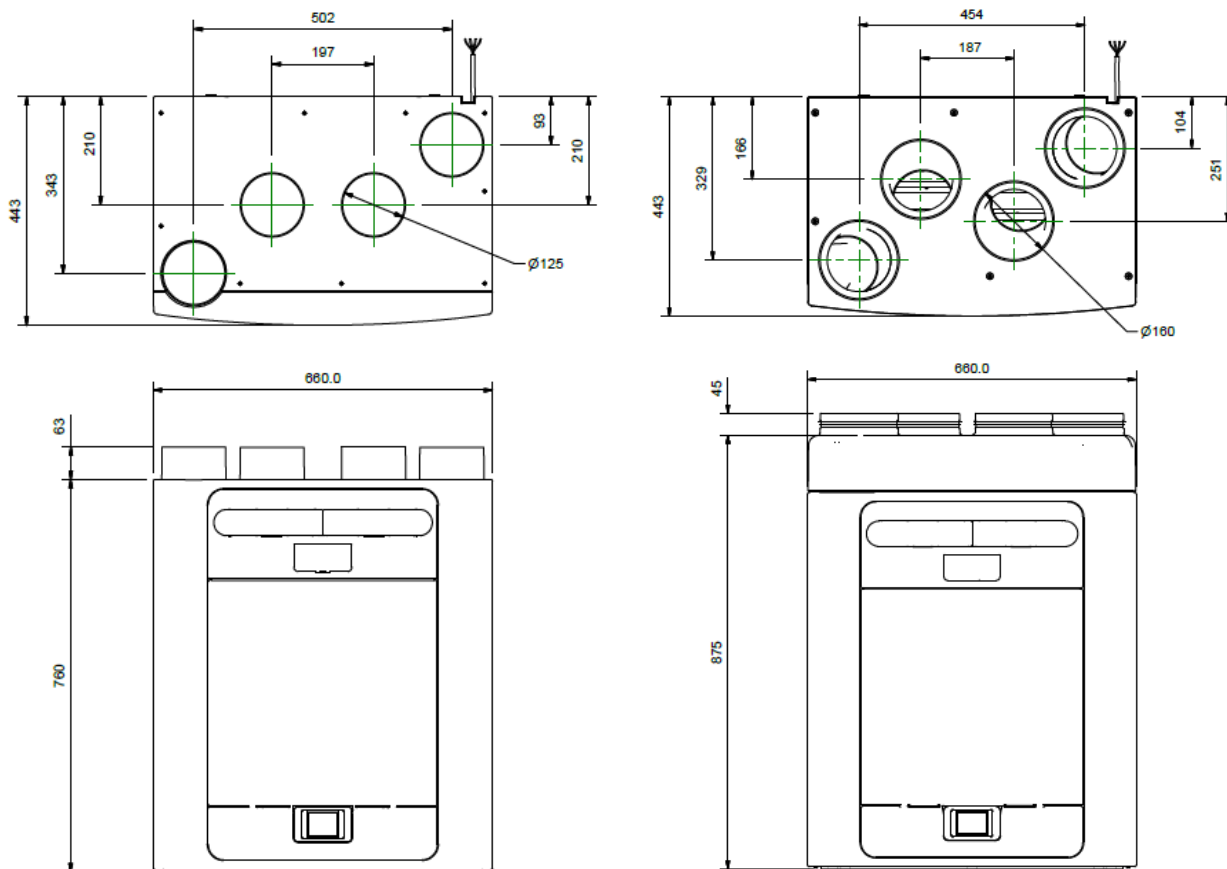

Figure 2: Dimensions

Remove front cover (see page 24) to view Rating label.
 (Label is positioned to the right of the controller).

Spares

The following spare parts may be ordered from Vent-Axia:

Part No	Description
472663	Main Power Board
472665	Control Module
472667	Filters G3, 2 per pack
472669	Filters M5, 1 per pack
472671	Filters F7, 1 per pack
472673	Motor Scroll Assembly
472675	Summer Bypass Motor Assembly
472685	Temperature/Humidity Sensor T1 (Right)
472679	Temperature Sensor T2 (Left)
472687	Temperature/Humidity Sensor T3 (Left)
472683	Temperature Sensor T4 (Right)
474529	Constant Volume + Clean Filter Pressure Sensors PCBA

Please note:

If the grade of filter used in the unit is changed from what was initially supplied, the performance of the preheater may be affected. An external preheater may be necessary depending on the specific installation and filter combination.

Default settings

Parameters	Settings
Commissioning Screens	
Country	United Kingdom
Language	English.
Date	Automatic - Factory set
Time	Automatic GMT/BST - Factory set
Unit configuration	Right Hand
Filter Check	12 months
Summer Bypass	Normal
Mode Names	Normal, Boost, Low, Purge
User Mode	
Boost Supply/Extract	50 %
Normal Supply/ Extract	30 %
Low Supply/Extract	20%
Purge Supply/Extract	100%
Internal RH Mode	On
Internal RH Setpoint	70%
Control Mode	Normal
Frost Protection	Airflow Mode
Mode schedule 1	All days set to 0:00 (on), 00:00 (off) – inactive
Mode Schedule 2	All days set to 0:00 (on). 00:00 (off) – inactive
Service Phone	Not Set
Set Lock code	0000
Indoor Temp	25 C
Outdoor Temp	14 C
Boost Over-run	Off
Boost Overrun set time	15
Boost Delay	Off
Boost Delay set time	00
LS1/LS2/LS3	User Mode 3 (Boost)
SW1/SW2/SW3/SW4/SW5	User Mode 3 (Boost)
Vent-Wise 1/2/3/4	User mode 3 (Boost) Load Pot (60 %) Time Pot (20 m)
Proportional 1/2	Humidity – Boost, Normal (60 %) CO2 – Boost (2000 ppm), Normal (1000 ppm) Temperature – Boost (27 C, Normal (17 C)

Table 2 Default settings

The touch screen controller consumes 0.5 Watts in stand-by mode when fitted to the MVHR unit. If required this controller may be removed from the unit and stored separately, further minimising the overall energy consumption.

Product fiche

Name:	Vent-Axia
Model ID (Stock Ref.) :	405215 Advance S 473881 Advance S Ventwise 405216 Advance SX 407808 Advance Sp LH 407809 Advance Sp RH 474020 Advance Sxp LH 474025 Advance Sxp RH
SEC Class	A+
SEC Value ('Average')	-43.85
SEC Value ('Warm')	-18.25
SEC Value ('Cold')	-89.33
Label Required? (Yes/No=Out of scope)	Yes
Declared as: RVU or NRUVU/UVU or BVU	RVU/BVU
Speed Drive	Variable Speed
Type HRS (Recuperative, Regenerative, None)	Recuperative
Thermal Eff: [(%), NA(if none)]	93
Max. Flow Rate (m3/h)	378
Max. Power Input (W): (@Max.Flow Rate)	190
LWA: Sound Power Level (dB)	50.0
Ref. Flow Rate (m3/s)	0.07350
Ref. Pressure Diff. (Pa)	50
SPI [W/(m3/h)]	0.25
Control Factor & Control Typology: (CTRL/ Typology)	
Control Factor; CTRL	0.65
Control Typology	Local Demand Control
Declared: -Max Internal & External Leakage Rates(%) for BVUs or carry over (for regenerative heat exchangers only), -&Ext. Leakage Rates (%) for Ducted UVUs;	<5% Internal, <5% External
Mixing Rate of Non-Ducted BVUs not intended to be equipped with one duct connection on either supply or extract air side;	N/A
Position and description of visual filter warning for RVUs intended for use with filters, including text pointing out the importance of regular filter changes for performance and energy efficiency of the unit	Refer to User Instructions
For UVUs (Instructions Install Regulated Supply/Extract Grilles Façade)	N/A
Internet Address (for Disassembly Instructions)	www.vent-axia.com
Sensitivity p. Variation@+20/-20 Pa: (for Non-Ducted VUs)	N/A
Air Tightness-ID/OD-(m3/h) (for Non-Ducted VUs)	N/A
Annual Electricity Consumption: AEC (kWh/a)	1.8
Annual Heating Saved: AHS (kWh/a)	
AHS: Average	47.56
AHS: Warm	21.50
AHS: Cold	93.03

Disposal



This product should not be disposed of with household waste. Please recycle where facilities exist. Check with your local authority for recycling advice.

The **Vent-Axia** Guarantee

Applicable only to products installed and used in the United Kingdom. For details of guarantee outside the United Kingdom contact your local supplier.

Vent-Axia guarantees its products for two years from date of purchase against faulty material or workmanship. In the event of any part being found to be defective, the product will be repaired, or at the Company's option replaced, without charge, provided that the product:-

- Has been installed and used in accordance with the instructions given with each unit.
- Has not been connected to an unsuitable electricity supply. (The correct electricity supply voltage is shown on the product rating label attached to the unit).
- Has not been subjected to misuse, neglect or damage.
- Has not been modified or repaired by any person not authorised by the company.

IF CLAIMING UNDER TERMS OF GUARANTEE

Please return the complete product, carriage paid to your original supplier or nearest Vent-Axia Centre, by post or personal visit. Please ensure that it is adequately packed and accompanied by a letter clearly marked "Guarantee Claim" stating the nature of the fault and providing evidence of date and source of purchase.

The guarantee is offered to you as an extra benefit, and does not affect your legal rights

Vent-Axia

Head Office: Fleming Way, Crawley, West Sussex, RH10 9YX.

UK NATIONAL CALL CENTRE, Newton Road, Crawley, West Sussex, RH10 9JA

SALES ENQUIRIES: Tel: 0344 8560590 Fax: 01293 565169

TECHNICAL SUPPORT: Tel: 0344 8560594 Fax: 01293 539209



476930 E

0518