

Aquarea range 2022 / 2023



AQUAREA



Welcome to Aquarea air to water heat pumps

From 3 kW to 16 kW, Panasonic's Aquarea air to water heat pumps range is one of the widest on the market, offering solutions for most properties, whatever their size and heating and cooling demands. Suitable for new build and refurbishment projects, the solutions are cost-effective with minimised environmental impact.

Highlighted features	→ 4	Fan coils highlighted features	→ 43
Introducing the Panasonic Aquarea – air source heat pump	→ 6	Smart fan coils	→ 44
Aquarea Heat Pump line-up	→ 8	Fan coils - ducted	→ 45
New Aquarea L Generation	→ 10	Fan coils - wall-mounted	→ 47
New Aquarea K Generation	→ 12	Wired controllers for AC and EC fan coils	→ 48
Aquarea All in One	→ 14	Sanitary tanks	→ 49
Aquarea High Performance	→ 16	Heat recovery ventilation unit	→ 51
Aquarea T-CAP	→ 18	Counter flow ventilation	→ 53
Aquarea commercial	→ 20	DHW Stand Alone	→ 55
Aquarea Smart and Service Cloud	→ 22	Accessories and control	→ 57
Control and connectivity	→ 24	Heating and cooling capacity tables	→ 61
Nearly Zero Energy Buildings (nZEB)	→ 26	Examples of installations	→ 67
Aquarea + PV Panels	→ 27		
Panasonic PRO Club	→ 28		
Aquarea Designer - online tool	→ 29		
Aquarea Heat Pumps range	→ 30		

Aquarea Hydrosplit

All in One L Generation · R290	→ 32
Bi-bloc L Generation · R290	→ 33

Aquarea High Performance

All in One K Generation · R32	→ 34
Bi-bloc K Generation - SDC · R32	→ 36
All in One J Generation R32	→ 35
Bi-bloc J Generation · R32	→ 37
Mono-bloc J Generation · R32	→ 38
Mono-bloc H Generation · R410A	→ 39

Aquarea T-CAP

All in One K Generation · R32	→ 40
All in One K Generation · R32	→ 41
All in One H Generation · R410A	→ 73
Mono-bloc J Generation · R32	→ 42

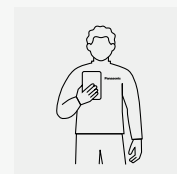
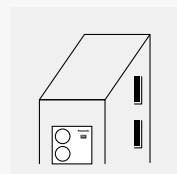
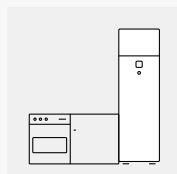
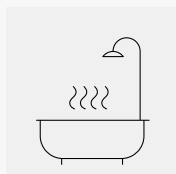
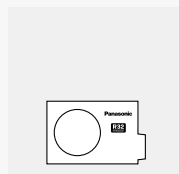

Highlighted features

Panasonic's Aquarea range of heat pumps deliver major energy savings thanks to its incredible efficiency even at -20 °C. The Panasonic Aquarea Heat Pumps are designed and produced by Panasonic and not by other companies.



The Aquarea Heat Pump is a system that generates the perfect temperature and produces hot water, in an easy, cheap and environmentally conscious way, by transferring heat instead of generating it. It is among the Technologies listed on the International Energy Agency (IEA) Blue Map, whose goal is to reduce CO₂ emissions to half the levels emitted in 2005, by the year 2050. Aquarea is part of a new generation of heating solutions that use a renewable, free energy source (the air) to heat or cool the home and to produce hot water.

Energy saving



Natural refrigerant R290 with GWP 3.

The new construction ensures a reduced noise level and increased safety for the use of R290.



Refrigerant R32.

Our heat pumps containing R32 refrigerant show a drastic reduction in the value of Global Warming Potential (GWP).



Better efficiency and value for medium temperature applications.

ErP 55°C

Energy efficiency class up to A++ in a scale from A+++ to D.



ErP 35°C

Better efficiency and Value for low temperature applications.

Energy efficiency class up to A+++ in a scale from A+++ to D.



DHW

Better efficiency and Value for domestic hot water.

Energy efficiency class up to A+ in a scale from A+ to F.



INVERTER+

Inverter Plus.

Panasonic Inverter Plus compressors are designed to achieve outstanding level of performance.



AUTO SPEED

A class water pump.

Aquarea are built-in with A class energy efficiency water pump. High efficiency circulating the water in the heating installation.



ErP 2018.

Compliant following COMMISSION REGULATION (EU) No2016/2281.



EC MOTOR GREEN VENTILATION

EC motor green ventilation.

Range of fan coils with improved efficiency and optional EC fan motors.

High performance and indoor air quality

5,33

COP

HIGH PERFORMANCE

Aquarea High Performance for low consumption houses.

From 3 to 16 kW. For a house with low temperature radiators or under-floor heating, our high performance Aquarea HP is a good solution. * COP of 5,33 for K and J Generation 3 kW.

-20°C

CONSTANT HEATING

T-CAP

Aquarea T-CAP for extremely low temperatures.

From 9 to 16 kW. If the most important aspect is to maintain nominal heating capacities even at temperatures as low as -7 °C or -20 °C, select the Aquarea T-CAP.

65°C

OUTPUT WATER

HIGH TEMPERATURE

Aquarea HT ideal for retrofit.

From 9 to 12 kW. For a house with traditional high-temperature radiators, the Aquarea HT solution is the most appropriate, can work in output water temperatures of 65 °C even at outdoor temperatures as low as -20 °C.



DHW

DHW.

With Aquarea you can also heat your domestic hot water at a very low cost with the optional hot water cylinder.

-20 °C

HEATING MODE

Down to -20 °C in heating mode.

The heat pumps work in heating mode with an outdoor temperature is as low as -20 °C.



WATER FILTER WITH MAGNET

Water filter with magnet.

Easy access and fast clip technology for J Generation onwards. Water filter only for H Generation.

75°C

OUTPUT WATER

FLOW TEMPERATURE

75 °C output water.

Reaches water outlet temperature up to 75 °C for L Generation.

65°C

OUTPUT WATER

FLOW TEMPERATURE

65 °C output water.

Reaches water outlet temperature up to 65 °C.



FLOW SENSOR

Water flow sensor.

Included on H Generation onwards.

High connectivity



BOILER CONNECTION

Renovation.

Our Aquarea Heat Pumps can be connected to an existing or new boiler for optimum comfort even at very low outdoor temperatures.



SOLAR KIT

Solar kit.

For even greater efficiency, our Aquarea Heat Pumps can be connected to photovoltaic solar panels with an optional kit.



ADVANCED CONTROL

Advanced control.

Remote controller with full dotted 3,5" wide back light screen. Menu with 17 available languages easy to use for installer and user. Included on H and J Generations.



INTERNET CONTROL

Internet control.

A next generation system providing user-friendly remote control of air conditioning or heat pump units from everywhere, using a simple Android™ or iOS smartphone, tablet or PC via the internet.



BMS CONNECTIVITY

BMS connectivity.

The communication port can be integrated into the indoor unit and provides easy connection to, and control of, your Panasonic heat pump to your home or Building Management System.



SG Ready



NF



Q



APPROVED PRODUCT



MCS



CERTIFIED



COMPLIANT

Aquarea H and J Generations heat pumps in combination with the optional PCB CZ-NSP4 hold the SG Ready Label (Smart Grid Ready Label), given by Bundesverband Wärmepumpe (German Heat Pump Association). This Label shows the real capacity of Aquarea to be connected in an intelligent grid control. MCS Certificate number: MCS HP0086*. Keymark: Check all our certified heat pumps on: www.heatpumpkeymark.com. Passive House Institute: Certified models can be checked in <https://database.passivehouse.com>.

* Not all products certified. As the certification process is on-going and the list of certified products constantly changing, please check for latest details on the official websites.

Warning on quality of water and groundwater use: This product is designed to comply with the European Water Quality Directive 98/83/EC amended by 2015/1787/EU. The lifespan of the product is not guaranteed in the case of the use of groundwater, such as spring water or well water, the use of tap water when salt or other impurities are contained, nor in areas of acidic water quality. Maintenance and warranty costs related to these cases are the customer's responsibility.

Introducing the Panasonic Aquarea – air source heat pump

At the forefront of energy innovation, Aquarea is resolutely positioned as a “green” heating and air conditioning solution.

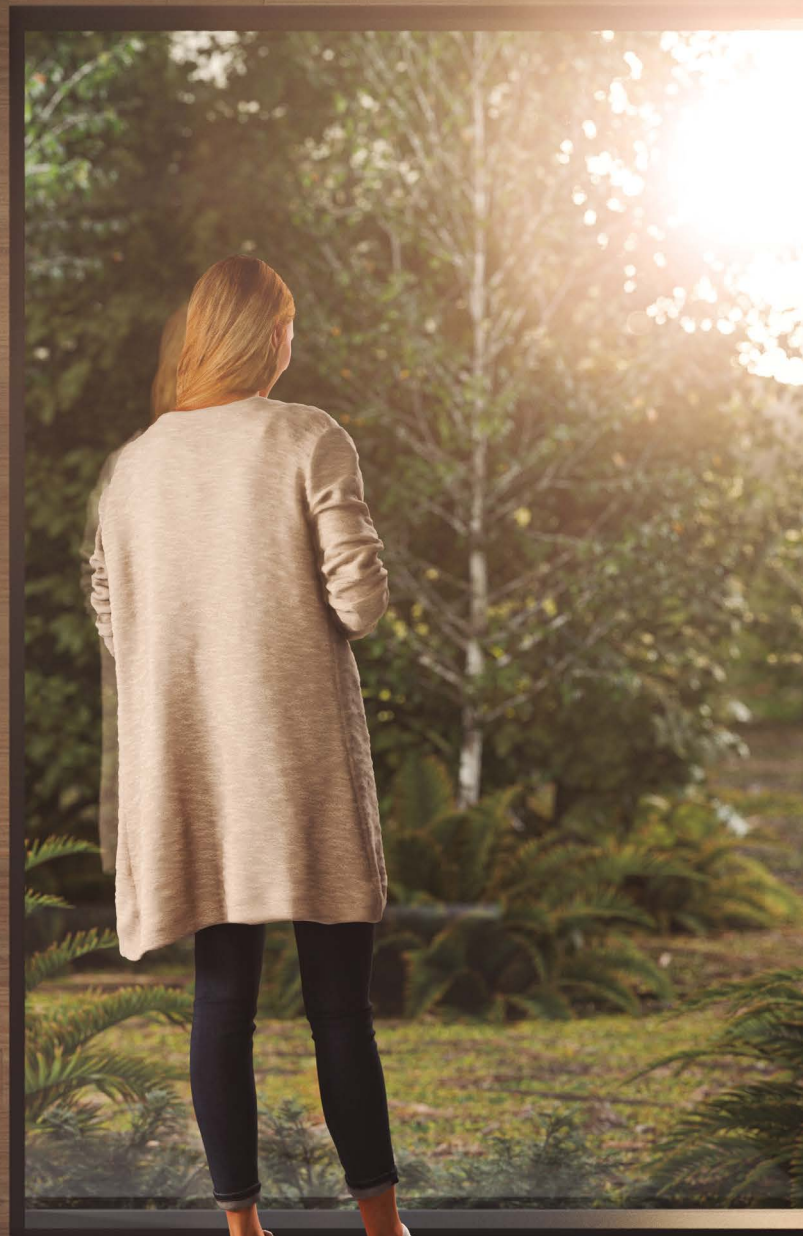

Introducing the Panasonic Aquarea – air source heat pump.

In European households, 79%* of energy consumption comes from heating and producing domestic hot water. By converting heat energy in the air into household warmth, highly efficient Aquarea technology reduces CO₂ emissions and environmental impact, compared to conventional boilers and electric heaters. Compared to an electric heater, the Aquarea Heat Pumps offer up to five times the output in kilowatts per every input in kilowatts.

* ec.europa.eu/eurostat

Comparison: 1 kW input versus output in kW.

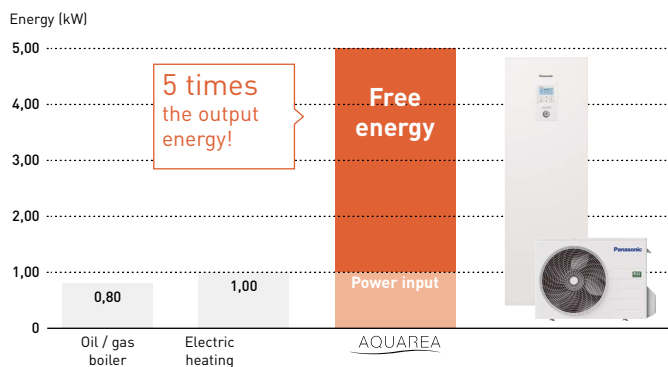

* 35 °C flow temperature.



Why Panasonic Aquarea air source heat pumps?

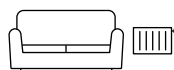

Optimum solutions for premium comfort.

Panasonic Aquarea Heat Pumps warm your home effectively and efficiently, to optimise the comfort.

- Precise control the indoor temperature thanks to reliable Panasonic Inverter Compressors
- Aquarea can cool space in summer and brings hot water all year round
- Night mode to reduce the noise when it's needed
- Aquarea T-CAP heat pumps can work in outdoor temperatures as low as -28 °C (for All in One and Bi-bloc)
- Energy savings, comfort and convenient control from any location thanks to Aquarea Smart Cloud
- Aquarea Service Cloud enables remote maintenance of the system



Energy saving means money savings.

Panasonic Aquarea Heat Pumps are a smart choice for saving in heating, all leading to large savings in electricity bills.

- Savings of up to 80% on heating expenses, compared to electrical heaters
- Up to A+++ in heating, within the range of A+++ to D, and A+ in domestic hot water, in the range of A+ to F
- Energy consumption can be further reduced by connecting photovoltaic panels to the system
- In combination with a ventilation solution, the indoor air becomes cleaner and the heating requirements of the building are reduced



Adapts to your needs.

Panasonic Aquarea Heat Pumps produce heating, cooling and domestic hot water with a single system.

- From 3 kW to 16 kW, there is always an option for lower initial investment and lower operational cost
- Aquarea can be connected to floor heating, radiators or fan coil units
- In refurbishment projects, Aquarea can be integrated in existing heating systems
- Providing water outlet temperatures of up to 75 °C down to -10 °C¹⁾
- Large piping length of up to 50 m between indoor and outdoor
- Aquarea T-CAP heat pumps guarantee the capacity without backup heating down to -20 °C²⁾

1) Aquarea L Generation. 2) At 35 °C flow temperature.



Contributing to a decarbonised society.

The heat pump is considered a 'green' choice as the heat energy is taken from the environment, making it a sustainable option.

- It maintains a comfortable indoor temperature while significantly reducing environmental burden
- All Aquarea Heat Pumps can also be connected to a solar thermal or PV system in order to increase efficiency and minimise environmental impact
- Aquarea L Generation heat pumps are engineered with natural refrigerant R290 with GWP 3

Aquarea Heat Pump line-up



All in One System.

The system, consisting of separate indoor and outdoor units, connects to the heating and/or hot water system. The indoor unit includes a stainless steel tank (185 L).

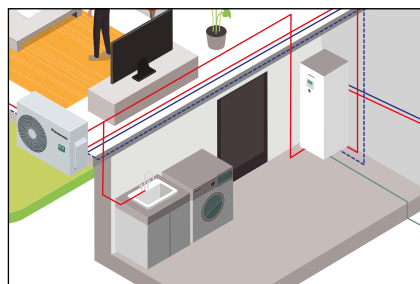

Bi-bloc System.



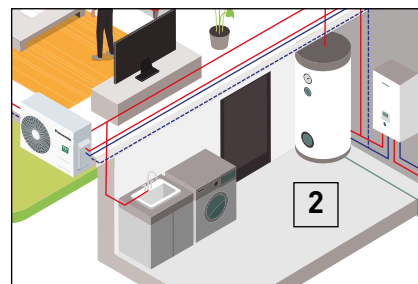

The system, consisting of separate indoor and outdoor units, connects to the heating and/or hot water system (tank not included).

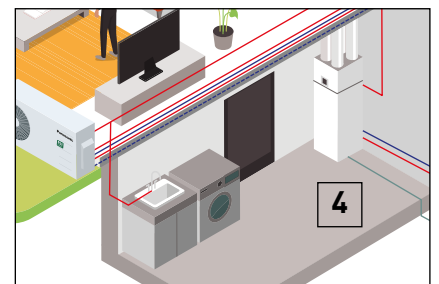

Mono-bloc System.

This only has an outdoor unit. The installation doesn't require a refrigerated connection and is only connected to the heating and/or hot water (tank not included).

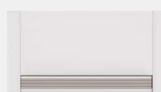

<div data-bbox="103 1904 151 1948" style="border: 1px solid black; padding: 2px;">1</div>  <p>Control through smartphone, tablet or computer (optional).</p>	<div data-bbox="454 1904 502 1948" style="border: 1px solid black; padding: 2px;">2</div>  <p>Super high efficiency cylinder (optional).</p>	<div data-bbox="813 1904 861 1948" style="border: 1px solid black; padding: 2px;">3</div>   <p>Fan coils for heating and cooling (optional).</p>	<div data-bbox="1165 1904 1212 1948" style="border: 1px solid black; padding: 2px;">4</div>  <p>Heat recovery Ventilation + DHW Tank (optional).</p>
---	---	---	---

Panasonic Aquarea offers you solutions, helping to make the home more efficient and the installation cheaper and easier.

Aquarea EcoFleX

For new installations, specially those with limited spaces.

Aquarea EcoFleX is a groundbreaking heat pump that connects an air ducted unit with nanoe™ X technology providing heat recovery hot water, space heating, space cooling and cleaner air. Outstanding efficiency and energy savings with low CO₂ emissions.

Aquarea High Performance

For new installations and low consumption homes.

Outstanding efficiency and energy savings with minimised CO₂ emissions and minimum space. Improved performance with COPs up to 5,33 for K and J Generation 3 kW.

Now also available with natural refrigerant R290.

Aquarea T-CAP

For extremely low temperatures, refurbishment and innovation.









Ideal to ensure that the heating capacity is maintained even at very low temperatures. This line-up is able to maintain the heat pump output capacity until -20 °C¹⁾ outdoor temperature without the help of an electrical booster heater.

1) At 35 °C flow temperature.

Aquarea HT

For a house with old high-temperature radiators.

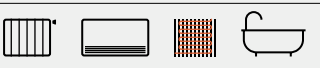
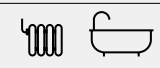
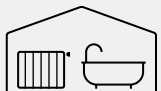
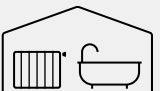
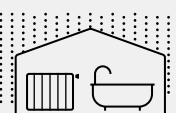
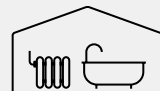
Ideal for retrofit: green energy source works with existing radiators. Aquarea HT Solution is the most appropriate, providing output water temperatures of 65 °C even at outdoor temperatures as low as -15 °C.

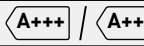
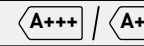
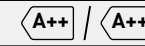
Aquarea EcoFleX	Aquarea High Performance		Aquarea T-CAP		Aquarea HT
 Heating - Cooling - DHW	 Heating - Cooling - DHW		 Heating - Cooling - DHW		 Heating - DHW
Connectable to					
 Radiators - Underfloor heating - DHW - Air conditioning	 Radiators - Fan coil - Underfloor heating - DHW		 Radiators - Fan coil - Underfloor heating - DHW		 Traditional high-temperature radiators - DHW
Application					
 New buildings	 New buildings and retrofit		 Extreme cold ambient and retrofit		 Retrofit for old radiators
Energy efficiency (Heating 35 °C / 55 °C ¹⁾)					
					
Control and connectivity					
Smart Grid Contact ²⁾ Wi-Fi included	Smart Grid Contact ²⁾ Wireless LAN Ready (included in L generation)		Smart Grid Contact ²⁾ Wireless LAN Ready		—

	Aquarea EcoFleX	Aquarea High Performance				Aquarea T-CAP			Aquarea HT
	J	L	K	J	H	K	J	H	F/G
Minimum outdoor temperature	-15 °C	-25 °C	-25 °C	-20 °C	-20 °C	-28 °C	-20 °C ³⁾	-28 °C	-20 °C
Maximum supply temperature for heating	55 °C	75 °C ⁴⁾	60 °C	60 °C	55 °C ⁵⁾	65 °C ⁶⁾	65 °C ⁶⁾	60 °C ⁵⁾	65 °C
Refrigerant	R32	R290	R32	R32	R410A	R32	R32	R410A	R407C
Type	Split + Duct	Hydrosplit	Split	Split or Mono-bloc	Split or Mono-bloc	Split	Mono-bloc	Split	Split or Mono-bloc
Single phase capacities	8 kW	5, 7, 9 kW	3, 5, 7, 9 kW	3, 5, 7, 9 kW	12, 16 kW	9, 12 kW	9, 12 kW	9, 12 kW	9, 12 kW
Three phase capacities	—	—	—	—	9, 12, 16 kW	9, 12 kW	9, 12, 16 kW	9, 12, 16 kW	9, 12 kW

All data in this chart is applicable in most of models in each line up, check product specs to confirm. 1) Scale from A+++ to D. 2) H and J Generations with CZ-NS4P. K and L Generations with CZ-NS5P. 3) 9, 12 and 16 kW. 4) DHW maximum temperature with heater. 5) In case of outdoor temperature over -10 °C. 6) It is possible to set temperature by 65 °C on remote controller. Normally, outlet water temperature is 60 °C or lower. In case of ΔT setting with remote controller is 15 °C and the outdoor ambient temperature is 5 to 20 °C, outlet water temperature 65 °C is possible.

New Aquarea L Generation

A revolution in design, efficiency, connectivity and sustainability. Aquarea L Generation is engineered with industry leading R290 natural refrigerant. It is the perfect solution for renovations, where a high water outlet temperature is required or homes looking for avant-garde heat pump with natural refrigerant.



Natural refrigerant GWP3. Save CO₂.



A next generation environment friendly heat pump that uses a low GWP refrigerant as a product that represents the Panasonic environmental concept of GREEN IMPACT.



Natural refrigerant

Employ natural refrigerant R290 with GWP 3.

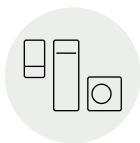

Improved clean design

Refined outdoor design to be blended to the environment.



Remote control and maintenance

Aquarea Smart Cloud. Aquarea Service Cloud.

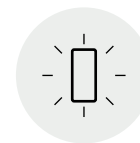

High tank insulation performance

Tank boasts high heat retention thanks to U-Vacua™¹⁾.



High energy efficiency for retrofit projects

A++ energy class at 55 °C water outlet temperature.

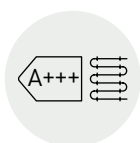

High energy efficiency for new buildings

Top class ErP for heating at 35 °C water outlet temperature²⁾.



High energy efficiency for domestic hot water

DHW COP up to 3,6²⁾.

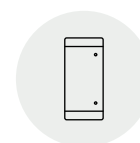

Further energy savings

Domestic hot water up to 65 °C without heater for tank sterilization.



Further flexibility.

- Hydraulic connection between Indoor and outdoor
- Less frequent maintenance with pre-installed magnet filter
- Operation without backup heating at -25 °C³⁾
- Water outlet temperature maximum 75 °C at -10 °C outside temperature
- Can supply 55 °C hot water even at -25 °C outside temperature³⁾
- Bluefin treatment protection on outdoor heat exchanger for harsh ambient conditions

1) U-Vacua™ is a vacuum insulation panel (VIP) technology. 2) Scale from A+++ to D. Might not apply to all the models. 3) Tentative feature.

The outdoor unit is designed to harmonize with architecture and the environment

Panasonic's unique low noise architecture.

The compressor, which is a major source of noise, is equipped with a double-bottomed structure to provide a safe, quiet structure that does not disturb neighbors in crowded residential areas.

Aquarea L Generation safety optimisation.

- 1 | Non-flammable control box
- 2 | Power box cable ground with sealed connections
- 3 | Air refrigerant separator

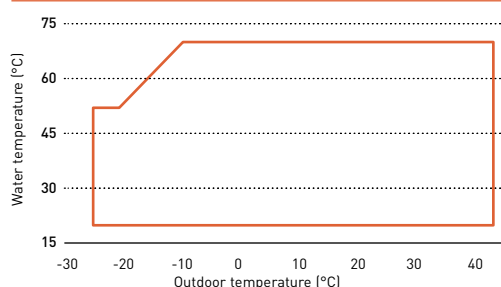
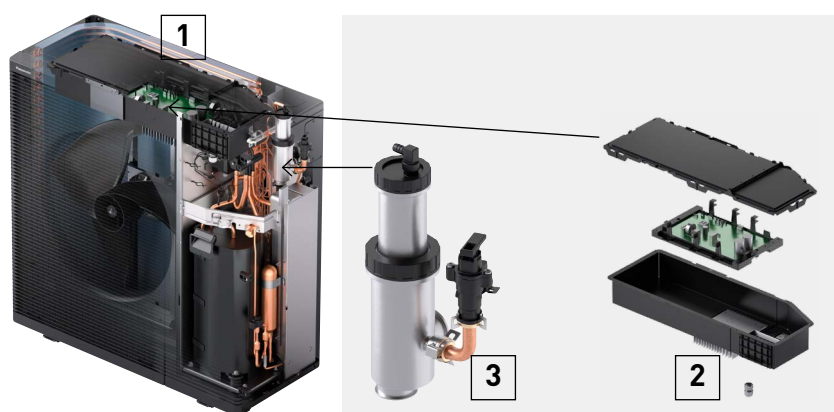

High performance under extreme conditions

Aquarea L Generation compressor operates without backup heating down to -25 °C ambient temperatures*, providing water outlet temperatures of up to 75 °C down to -10 °C. Even at -25 °C outside temperature, Aquarea L Generation heat pumps can supply hot water at 55 °C*.

* Tentative feature.

New Aquarea K Generation

A revolution in design, efficiency, connectivity and sustainability. Aquarea K Generation is a ground breaking low-energy system for heating, cooling and domestic hot water production that delivers outstanding performance. This model is ideal for new installations and well-insulated homes.



Harmony between technology and home.

In our daily lives, technology is attuned to you and the environment around you, without overstating the device or interface. Just as the air is always around you even if you're not aware of it, Panasonic's technology continues to be in tune with your environment and your life.



Wide range

Wide range to suit all homes: High Performance and T-CAP.

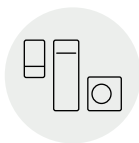

Improved clean design

Refined outdoor design to be blended to the environment.



Optional remote control and maintenance

Aquarea Smart Cloud.
Aquarea Service Cloud.

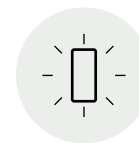

High tank insulation performance

Tank boasts high heat retention thanks to U-Vacua™¹⁾.

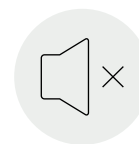

Further noise reduction

Panasonic's unique low noise architecture.



High energy efficiency for heating

High energy class for low and medium temperature applications.

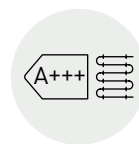

High energy efficiency for heating

High energy class for low and medium temperature applications.



High energy efficiency for domestic hot water

DHW COP up to 3,5²⁾.



Further flexibility.

- Less frequent maintenance with pre-installed magnet filter
- Easy access to hydraulic parts
- Operation without backup heating at -25 °C³⁾
- Can supply 60 °C hot water even at -10 °C outside temperature
- Bluefin treatment protection on outdoor heat exchanger for harsh ambient conditions

1) U-Vacua™ is a vacuum insulation panel (VIP) technology. 2) Scale from A+++ to D. Might not apply to all the models. 3) Tentative feature.

All in One unit and Bi-bloc indoor unit are designed to blend into your interior space effortlessly

Like indoor equipment, the outdoor unit is designed to harmonize with architecture and the environment while quietly supporting the precious time spent with the warm family.

The optional WLAN adapter CZ-TAW1B, can be simply connected through our new front panel, offering flexible and intuitive connectivity.

The outdoor unit is designed to harmonize with architecture and the environment

The outdoor units, with an anthracite grey colour which will dress the entire range, have been completely redesigned with an innovative design that will find its place in all spaces.

Panasonic's unique low noise architecture.

The compressor, which is a major source of noise, is equipped with a double-bottomed structure to provide a safe, quiet structure that does not disturb neighbours in crowded residential areas.



-8 dB(A) in quiet mode

Aquarea All in One

The Aquarea All in One unit is the ultimate space-saving solution. Its 599 x 602 mm footprint, standard size of other big appliances, reduces the space required for the installation.



Aquarea All in One: the best Panasonic technology for your home.

High quality components inside:

- Maintenance free Inox stainless 185 l tank
- Variable speed water pump (class A)
- Less frequent maintenance with pre-installed improved magnet filter
- Expansion vessel
- Vortex flow sensor
- Back up heater
- Safety valve
- Air purge valves
- 3 way valve inside

The ultimate space-saving solution.

- 599 x 602 mm footprint reduces required installation space
- Low height leaves space for a ventilation unit
- No buffer tank required, reducing space, cost and installation time

Aquarea All in One Compact: Made compact but maintenance is still easy



Great serviceability.

- Easy maintenance concept is retained
- Easy access to hydraulic part thanks to door opening mechanism
- No buffer tank required, reducing space, cost and installation time
- All sensors can be checked from the remote controller (new)
- Water pressure sensor (new)

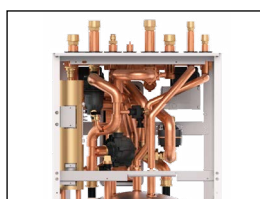

Slimmer, yet same tank capacity.

Piping layout at the top in order to maintain large 185 L tank capacity.



Improved water filter for less maintenance.

Dust removal capacity of the water filter has been increased 5 times. Less frequent filter cleaning means more convenience.



Robust body for top ventilation unit.

Strengthening the body and top surface with a frame enables installation of a top ventilation unit. For safety, it's secured with bolts to prevent it falling.



U-Vacua™; Vacuum insulation panel. Significant energy savings with world-leading insulation performance.

Because they leverage VIP technology, U-Vacua™ panels offer 19 times the insulation performance of polystyrene foam. Since the system retains heat longer, it needs to heat up fewer times each day, resulting in energy savings.

U-Vacua™ VIPs consist of a unique fiberglass core encased in a laminate film made up of several layers that include nylon, aluminium, and a protective layer. Interior pressure is reduced to a vacuum of 1-20 Pa, thereby minimising thermal conductivity.

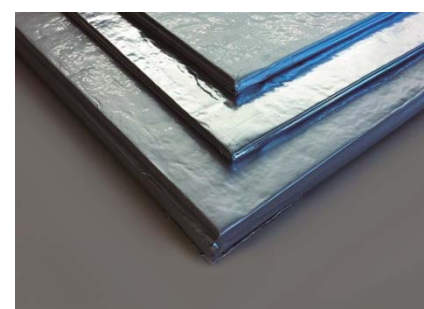

Aquarea All in One with 2 zone control: The optimal solution for an installation with 2 heating zones.

- 2 heating circuits, with 2 different water temperatures
- 2 water pumps and 2 water filters
- Floor heating water control with mixing valve

Aquarea All in One with Electrical Anode:

The All in One with built-in impressed current anode is the ideal solution for installations in locations with harsh water conditions.

Aquarea High Performance

For new installations and low consumption homes. Outstanding efficiency and energy savings with minimised CO₂ emissions and minimum space.



High Performance helps you to meet strict building requirements and reduce building costs.

The heating and production of domestic hot water have a very important impact on the energy consumption of a house. Efficient Panasonic heat pumps can help to significantly reduce the energy consumption of the house.

Key points of the line-up

- Improved performance with COPs up to 5,33 for K and J Generations 3 kW
- Reduced energy consumption through our circulating pump with energy efficiency class "A"
- Remote controller functions added: Auto mode, holiday mode, power consumption display

Panasonic has designed the Aquarea All in One, Bi-bloc and Mono-bloc heat pumps for homes which have high performance requirements. Whatever the weather, Aquarea can work even at -20 °C! The Aquarea is easy to install on new or existing installations, in all types of properties.

High Performance Heat Pumps are highly efficient (KIT-ADC03JE5 for example)

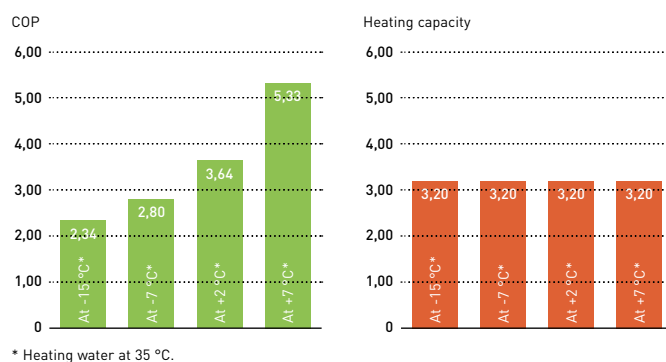

Standard circulating pumps vs our circulating pump with energy efficiency class "A"

Comparison of energy consumption of circulation pumps. Circulating pump with energy efficiency class "A" with Dynamic flow control for 5 kW Mono-bloc.

* Based on German market: Assuming Standard pump may vary depending on consumption and energy cost.

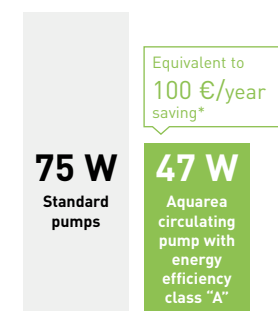

Panasonic created a night mode to reduce the noise when it's needed

Special attention has been given to noise levels.

- 1) Sound pressure measured at 1 m from the outdoor unit and at 1,5 m height.
- 2) At standard condition working at heating capacity at +7 °C (heating water at 35 °C) for two fans outdoor units. For one fan outdoor units, night mode reduction is 3 dB(A).

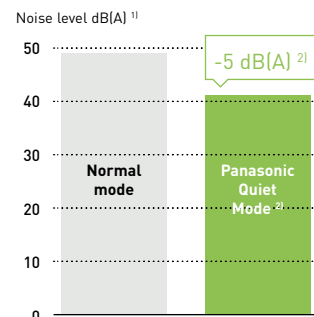

High Performance J Generation keeps 60 °C water outlet temperature even at very low temperatures

Aquarea High performance J Generation is able to keep 60 °C water outlet temperature in outdoor temperatures down to -10 °C, keeping high comfort in the room even at low temperatures. With other heat pumps, water temperature dramatically drops at low outdoor temperatures, making the heat pump to work out of the design conditions and creating discomfort inside the room.

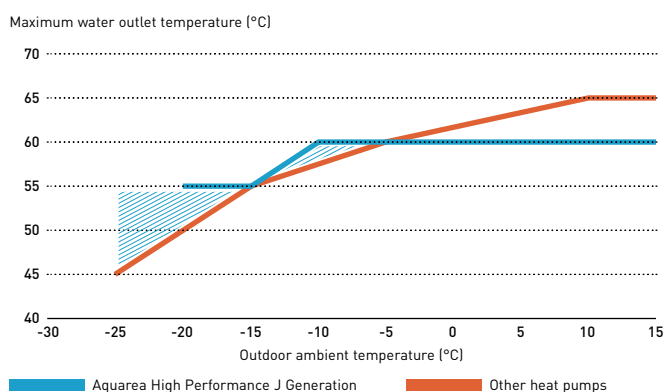

Aquarea T-CAP

For retrofit and new builds, Aquarea T-CAP is the ideal solution for those installations where the output capacity is demanding. The entire Aquarea T-CAP line-up is excellent for replacing gas or oil boilers and for connecting to new underfloor heating, radiators or fan coil units. Aquarea T-CAP can maintain the heat pump output capacity until $-20\text{ }^{\circ}\text{C}$ ¹⁾ outdoor temperature without the help of an electrical booster heater, offering high heating capacity even at low ambient temperatures.

1) At $35\text{ }^{\circ}\text{C}$ flow temperature.



Aquarea T-CAP Mono-bloc J Generation R32.

R32 Refrigerant: A 'small' change that changes everything.

With Mono-bloc, the refrigerant circuit is sealed inside the outdoor unit, so there is no need to worry about the amount of refrigerant per room.

65 °C¹⁾ water temperature possible.

By optimising the system and the refrigerant cycle, the unit can work under higher pressure and realise a water temperature of 65°C.

1) In case of ΔT setting with remote controller is 15 °C and outdoor ambient temperature is 5 to 20 °C, 65 °C hot water temperature is possible. Even with the T-CAP series, capacity will drop when water temperature reaches 65 °C.



How Aquarea T-CAP maintains performance even at -20 °C outdoors

A patent has been obtained for technology that can maintain heating capacity even in low outdoor temperatures through optimal control that comes from incorporating dual-piped heat exchanger into the refrigeration cycle.

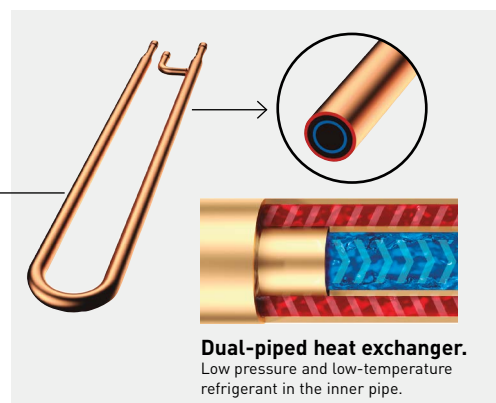

Higher efficiency compared to other heating systems

Panasonic heat pumps have a maximum COP of 5,08 at +7 °C which makes them much more efficient than others heating systems.

T-CAP is also able to provide extremely high efficiencies, whatever the outside or the water temperature.

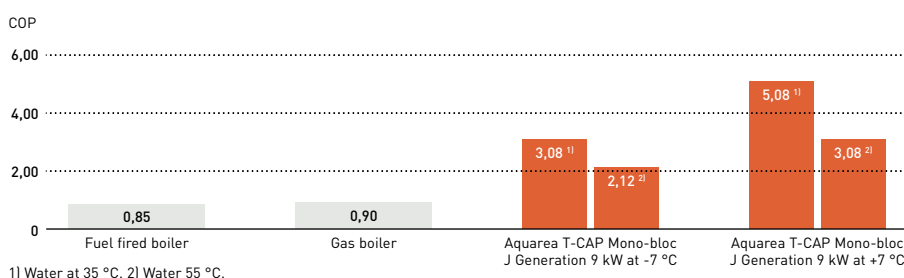

No need to oversize to reach required capacity at low temperatures

With Aquarea T-CAP technology, Panasonic heat pumps can work in outdoor temperatures as low as -20 °C and maintain capacity without backup heating at -20 °C¹⁾. With other heat pumps, a larger capacity is required to achieve the same level of comfort at low temperatures.

1) 35 °C flow temperature.

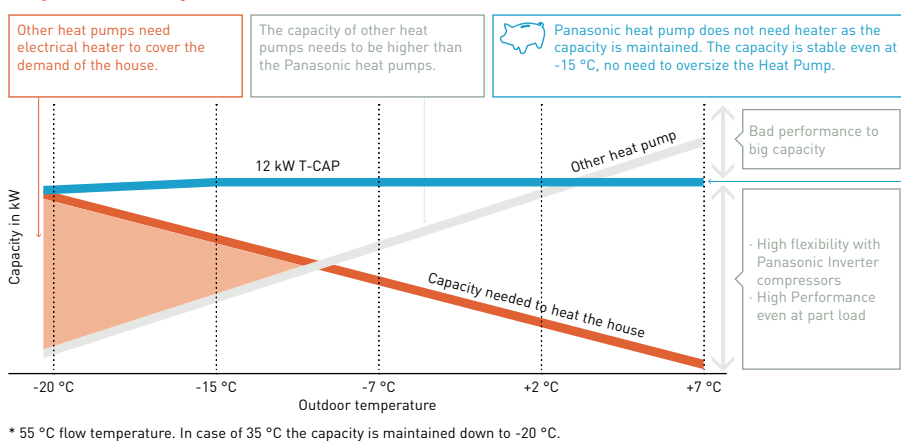

Aquarea Super Quiet T-CAP Bi-bloc

The special outdoor chassis notably reduces operation sound by up to 15 dB.^{1) 2)}

1) When comparing WH-UQ12HE8 at quiet mode level 3 operation with WH-UX12HE8 at full load operation. 2) Heating capacity may drop.

Aquarea commercial

Solutions for best savings. Efficient Panasonic heat pumps can help to significantly reduce the energy consumption of your business.

Restaurant with Aquarea.

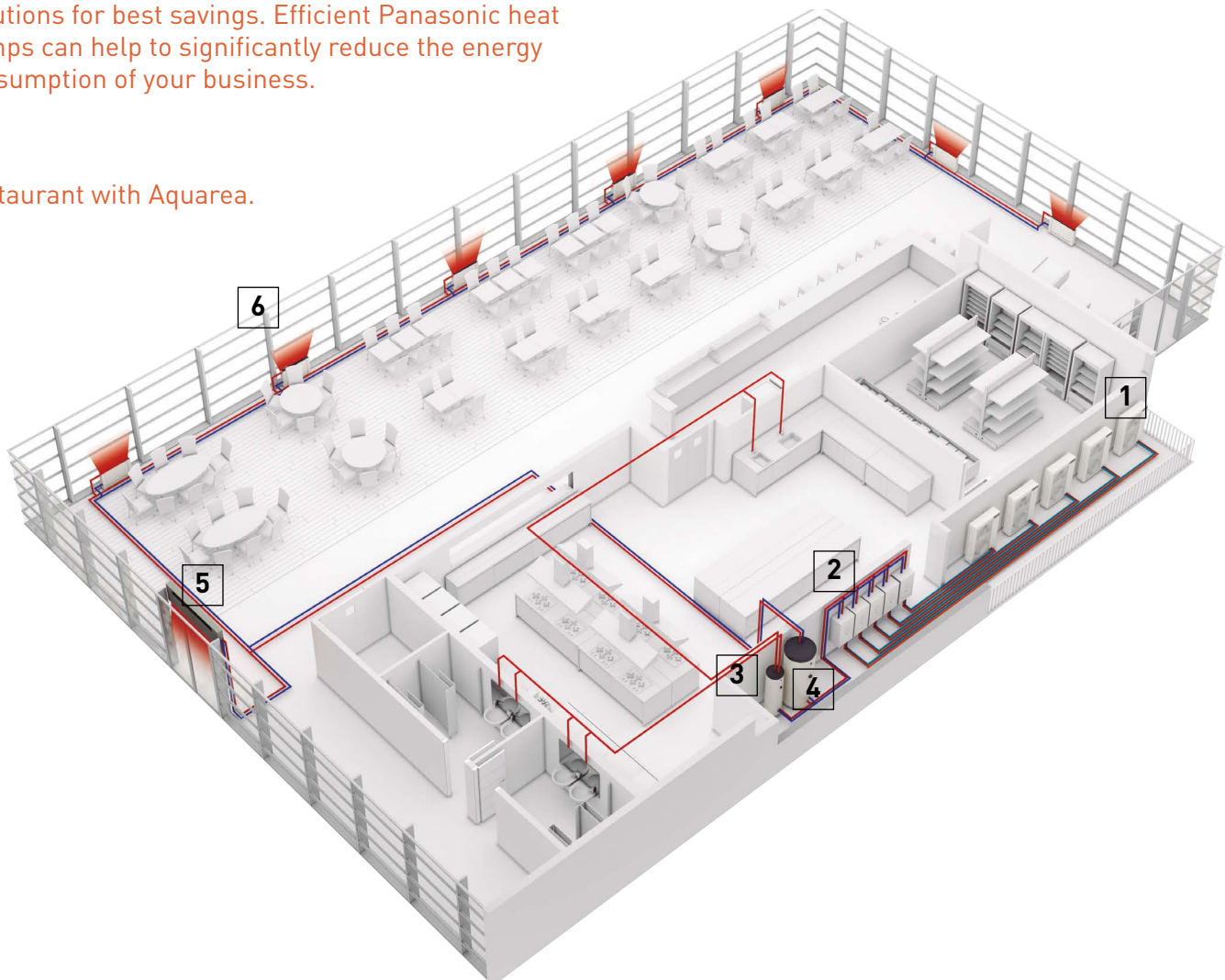

1 Aquarea T-CAP.
16 kW heat pumps on cascade mode. T-CAP line-up is an ideal replacement for old gas/oil boilers.



2 High efficiency Aquarea T-CAP hydromodule.
Indoor unit of Aquarea Bi-bloc systems. When a Mono-bloc system is used, the hydromodule is integrated in the outdoor unit.



3 Super high efficiency Tanks.
Combining Panasonic Aquarea with a high efficiency tank ensures the desired volume of hot water, at the correct temperature while reduced energy costs.

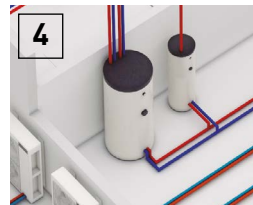

4 Buffer Tank.
Panasonic Aquarea can be combined with the hydraulic elements of the new or existing water system.



5 Air Curtain with water Coil.
Water coil air curtains can be used in the hydraulic system to have efficient performance of the water system.



6 Fan coils for heating and cooling.
Aquarea Heat Pumps can be easily connected to the existing water system: 2 way and 4 way fan coils, floor heating, DHW tanks...

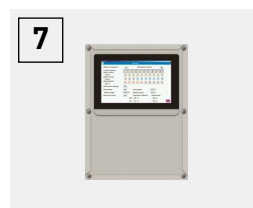

7 Cascade manager.
The cascade manager enables the control of up to 10 Aquarea Heat Pumps (balancing the working hours and making the operation more efficient) and up to 2 buffer tanks.

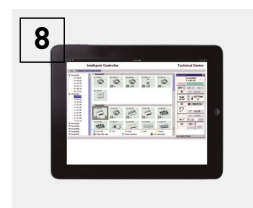

8 BMS integration.
The cascade system can be easily integrated in a Modbus project thanks to the cascade manager.

Panasonic Aquarea Heat Pumps offer space saving, energy-efficient heating and can be easily adapted for installation in flats, houses and commercial premises. Businesses producing heating, cooling and big quantities of hot water at 65 °C, such as restaurants or supermarkets, installing an Aquarea Heat Pump system can also use this wasted heat to improve energy efficiency further. Heat pump technology is scalable, meaning that it can be installed in buildings of varying sizes, offering both small and large-scale heating solutions. The technology is also environmentally friendly when compared to traditional

heating systems alternatives based on fossil fuel energy and in addition it is more energy efficient.

Key points:

- Efficient hot water production
- Fast return of investment
- Easy control
- Easy integration in the existing water system: fan coils, floor heating, domestic hot water tanks, etc
- Very good part load management
- High efficiency

Supermarket with Aquarea.

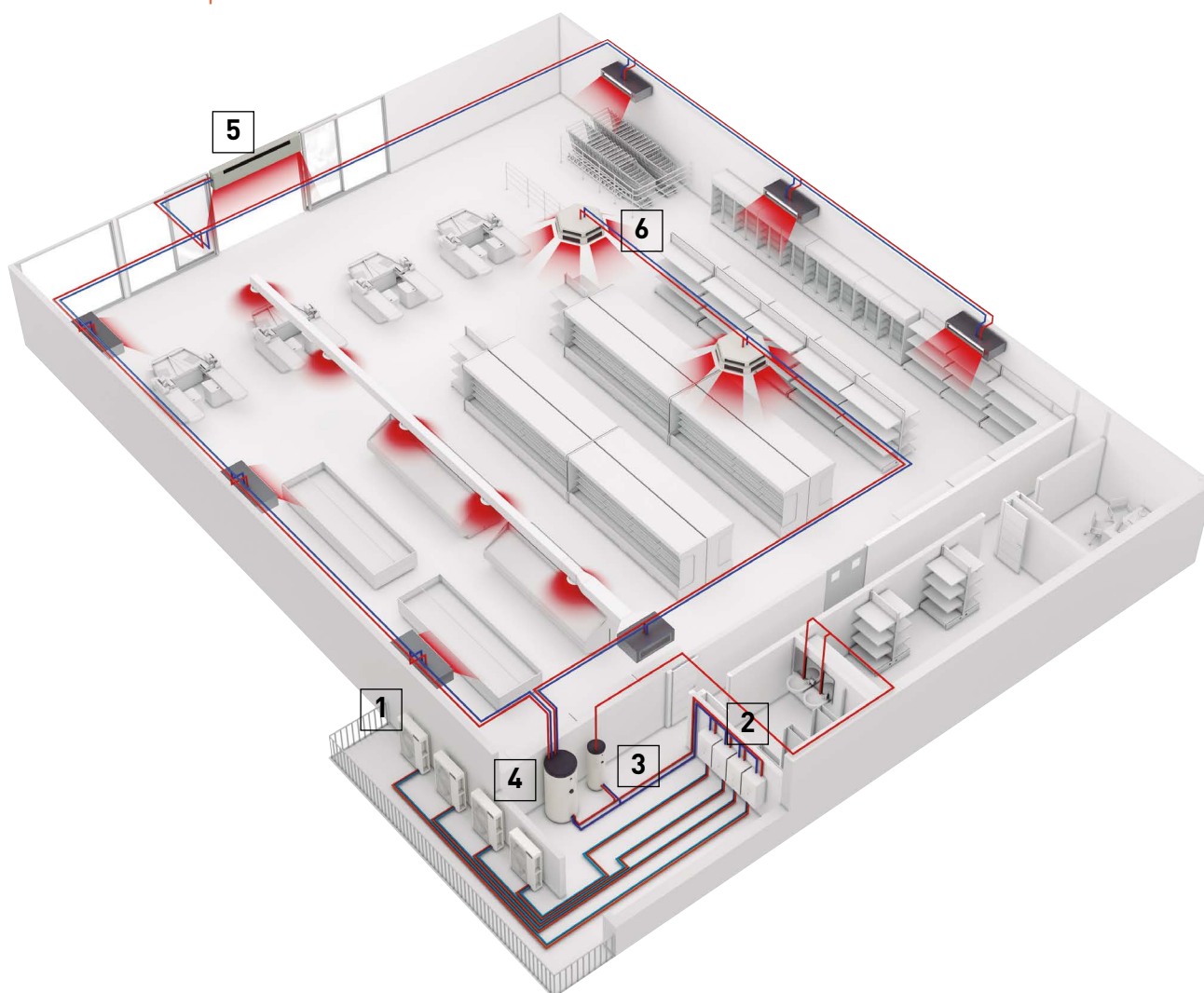

Burger & Lobster restaurant. Bath, UK.

Panasonic's air to water Aquarea system has been installed in the latest glamorous Burger & Lobster restaurant in Bath. The Octagon Chapel, a large listed building in the city centre, was converted to accommodate the restaurant, and Panasonic's Aquarea system provided an extensive, energy efficient and unobtrusive heating and cooling solution.



Carluccio's restaurant. UK.

One of UK's leading Italian restaurant, Carluccio's, wanted to install a system which would provide the desired volume of hot water, at the correct temperature while at the same time reduced energy costs. FWP installed a 12 kW Aquarea T-CAP mono bloc unit which would allow for the free air from the kitchen roof space to be transferred through condensing unit providing hot water at the optimum temperature.

Aquarea Smart Cloud for the users

The most advanced heating control for today and for the future. Aquarea can be connected to the Cloud with the accessory CZ-TAW1B, enabling both user control and remote maintenance by service partners.

WATCH DEMO

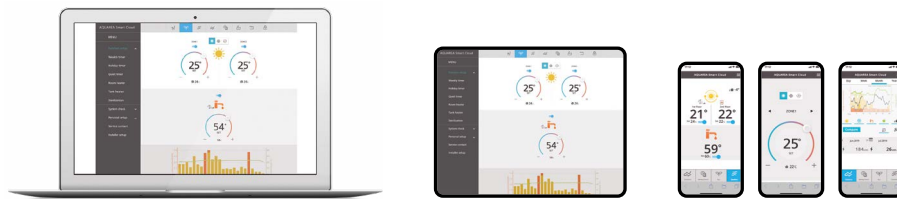

* User interface image may change without notification.

Easy and powerful energy management

The Aquarea Smart Cloud is much more than a simple thermostat for switching a heating device ON or OFF. It is a powerful and intuitive service for remotely controlling the full range of heating and hot water functions, including monitoring energy consumption.

How does it work?

After connecting an Aquarea J or H generation to the cloud by wireless LAN or by wired LAN, the user accesses the Cloud portal to remotely operate all functions of his units. He can also permit service partners to access customised functions for remote maintenance and monitoring.

Requirements

1. Aquarea J or H Generation
2. In-house internet connection with router wireless LAN or wired LAN
3. Get a Panasonic ID in <https://aquarea-smart.panasonic.com/>

Functions:

- Visualization and Control
- Scheduling
- Energy Statistics
- Malfunction notification



More possibilities with IFTTT.
IF This Then That: IFTTT service enables user to automatically trigger actions for Aquarea system based on other apps, web services or devices.

Connect your Aquarea to your voice assistant, get an e-mail if your Aquarea gets an error or automatically turn on your Aquarea on Heat Mode when outdoor temperature drops below specified level.

Advantages

Energy savings, comfort and control from anywhere. Increased efficiency and resources management, operating costs savings and owner satisfaction. The Aquarea Smart Cloud services are focused on enabling full remote maintenance of the Aquarea system. This allows maintenance specialists to engage in predictive maintenance and system fine-tuning, as well as fixing malfunctions when they occur.

Aquarea compatibility	H and J Generations
Connection point	CN-CNT Aquarea port
Home router connection	Wireless or Wired LAN
Temperature sensor	Can use remote controller sensor
Tablet or PC browser compatibility*	Yes
Operation from remote — ON / OFF — Temperature setting Mode selection — DHW setting — Error codes — Scheduling	Yes
Heating areas	Up to 2 zones
Power consumption estimation — Operation log history	Yes — Yes

* Check browsers and version compatibility.

Get the most out of your Aquarea Heat Pump.

Aquarea+ offers end user useful information to operate a Panasonic Aquarea Heat Pump to provide heating, cooling and hot water in the most efficient and cost effective way.

AQUAREA+



Aquarea Service Cloud for installers or maintenance companies

WATCH DEMO



The Aquarea Service Cloud allows installers to take care of their customers' heating systems remotely. It saves time and money and shortens the response time, thus increasing the customers' satisfaction.

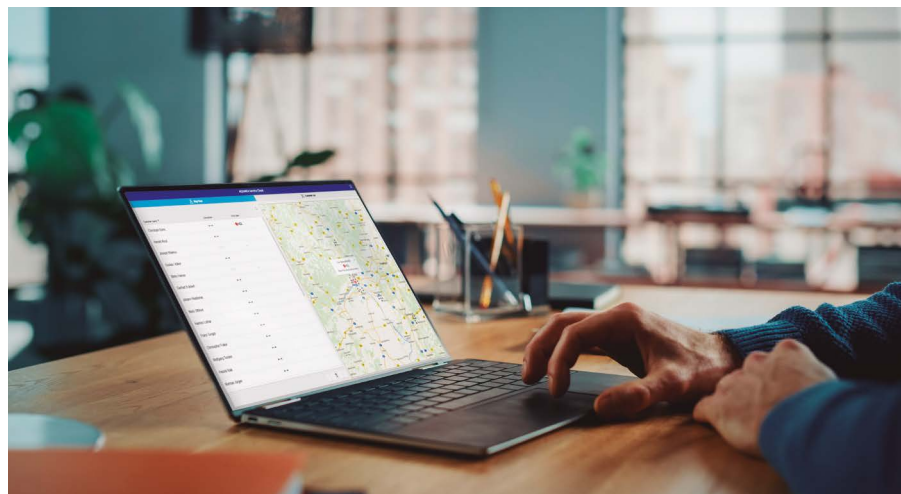

The real remote maintenance made simple

Advanced functions for remote maintenance with professional screens:

- Global view at a glance
- Error log history
- Full unit information
- Statistics always available
- Most settings available

Home page.

Status of connected users at a glance. 2 view options: map view or list view.

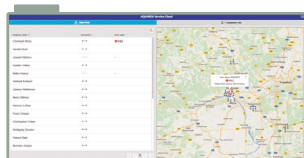

Status tab.

Current status of unit with a maximum 28 parameters.



Statistics tab.

Customisable statistics of a maximum of 71 parameters. Available anytime with the information of the last 7 days.

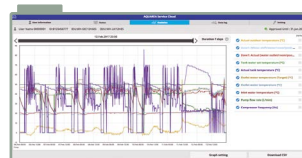

Settings tab.

Most of the user and installer settings can be done remotely.

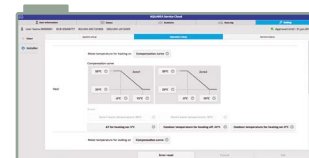

Activation of the Aquarea Service Cloud

Requirements.

Hardware and connection	End user registration	Installer / maintenance registration
J or H Generation Aquarea connected to CZ-TAW1B	Get Panasonic ID	Get Service ID
In-house internet connection with Wireless LAN or Wired LAN	Aquarea Smart Cloud	Aquarea Service Cloud

Connecting the unit to the Aquarea Service Cloud.

The process can be initiated by the end user or by the installer.

The end user can select and change the installer's level of control anytime (4 levels).

Installer registration: <https://aquarea-service.panasonic.com/>

End user registration: <https://aquarea-smart.panasonic.com/>

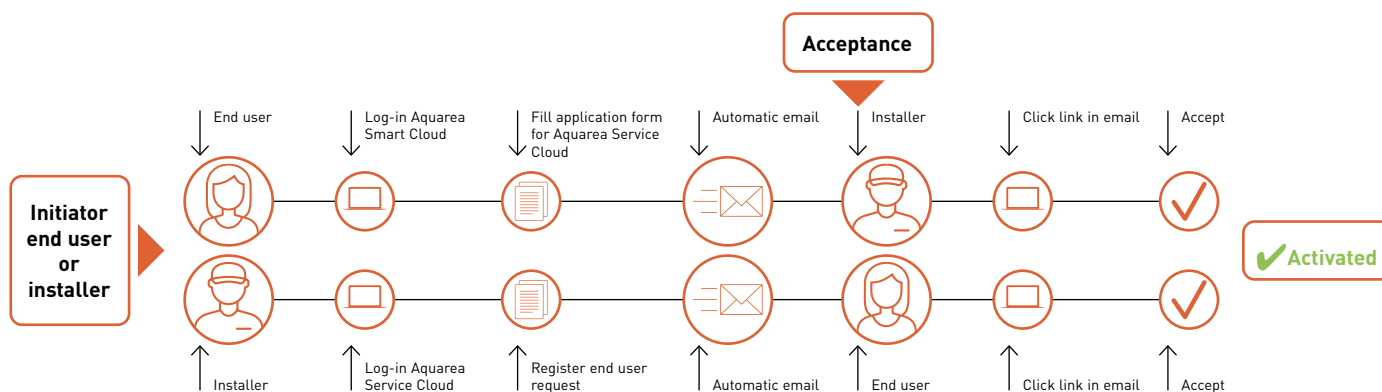

Control and connectivity

Home connectivity and Home Managements Systems integration is becoming more and more popular. These integrations helps to control all house devices from centralised platform and helps to optimise the operation and running costs. Panasonic interfaces are made to work with both KNX and Modbus, the most populars protocols. Also for non integrated control, Panasonic developed a simple connection to Wireless LAN, with this end user can control remotely its own heat pump from wherever.



Control by BMS

Modbus: PAW-AW-MBS-H (Intesis) and PAW-AZAW-MBS-1 (Airzone).
KNX: PAW-AW-KNX-H (Intesis) and PAW-AZAW-KNX-1 (Airzone).

Great flexibility for integration into your KNX / Modbus projects allows fully bi-directional monitoring and control of all the functioning parameters.

- Quick installation
- External power not required
- Direct connection to the unit via CN-CNT connector
- Bidirectional control
- Unit can be controller simultaneously by remote controller and the gateway
- Compatible with H, J, K and L Generations

* For specific functionality list of each gateway, please check the user's manual.



External meter gateway

PAW-A2W-EXTMETER

- Energy consumption and production from external Modbus RTU meters
- Real values visualized via Aquarea remote controller and Aquarea Smart Cloud
- Compatible with Aquarea K and L Generations



Possibility to mix internal calculation and external meters

Configuration	Electricity meter (HP)	Heat meter (heating and cooling)	Heat meter (DHW)
Only external meters	External	External	External
Only external consumption meter	External	Internal calculation	Internal calculation
Only external production meters (2 meters)	Internal calculation	External	External
Only external production meter (single meter for total production)	Internal calculation	External	Internal calculation

Functions:

- Configuration via App (iOS and Android) using Bluetooth®
- Easy to setup thanks to templates for some meters manufacturers
- Configuration can be done before and just send it on commissioning

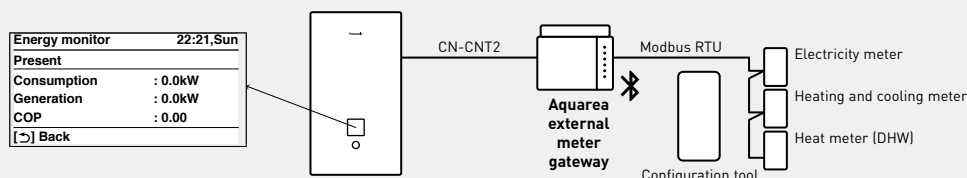

Advanced remote controller

Aquarea remote controller is designed in harmony with the whole system, with optimised user interface and improved features.

The remote controller can be removed from the indoor unit and installed in the living room.

K and L Generations remote controller.

Dual controller system: A dual controller system for independent control of two zones within the home (requires additional remote controller CZ-RTW1).

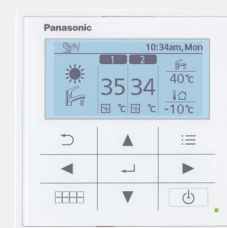
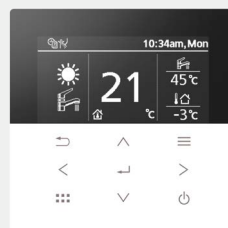
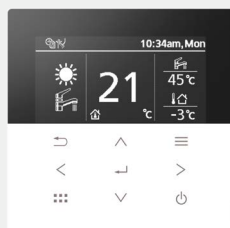

	K and L Generations				H and J Generations	
	Main controller		Sub controller		Main controller	
Quick menu	✓		✓		✓	
User menu	✓		✓		✓	
Installer / custom menu	✓		—		✓	
Maintenance menu	✓		—		✓	
Error reset	✓		✓		✓	
Internal thermostat	Zone 1	Zone 2	Zone 1	Zone 2	Zone 1	Zone 2
	✓	✓	✓	✓	✓	✓

Installer functions:

System setup, operation setup (including heating / cooling modes, ΔT setup), dry concrete mode and cost-effective bivalent mode*, among others.

* Only for K and L.

End user functions:

Mode selection (including auto, powerful and quiet modes), weekly timer and energy monitoring, among others.

PCB for additional functions

CZ-NS4P: Optional PCB for Aquarea H and J Generations.

CZ-NS5P: Optional PCB for Aquarea K and L Generations.

The optional PCB enables additional control functions for Aquarea heat pumps.

Functions available through the connection of the Optional PCB to the Main PCB:

- 2-zone control, with 2 mixing valves, 2 pumps and 2 room thermostats or sensors
- Control of swimming pool
- Buffer tank temperature sensor (available in the main controller for K and L Generations)
- Solar thermal control
- External error signal output
- 0-10 V signal for heat pump demand control
- SG ready²⁾
- Stop compressor by external compressor switch
- Switch heating and cooling by external heat-cool switch

1) Aquarea H and J Generations heat pumps in combination with the optional PCB CZ-NSP4 hold the SG Ready Label (Smart Grid Ready Label), given by Bundesverband Wärmepumpe (German Heat Pump Association). This Label shows the real capacity of Aquarea to be connected in an intelligent grid control.

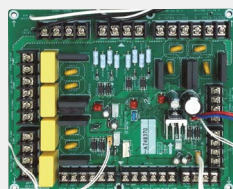

Cascade manager

PAW-A2W-CMH-2

- Cascade up to 10 heat pumps, getting up to 160 kW
- Manages the heat demand based on a PID logic, balancing working hours
- Integration of photovoltaics (PV optimised algorithm)
- Can control 3 way valves for cooling (2 buffer tanks)
- Heating / cooling 0-10 V demand signal – controls target outlet temperature
- DHW control
- Energy meters compatibility
 - Meters communication with Modbus RTU
 - Pre-configuration of 4 market popular meters
- BMS integration. LAN-Port settings with fixed IP and DHCP
- Optimised De-icing function
- Large, easy-to-use touch screen display, providing intuitive control
- All components in one case
- Compatible with Aquarea Heat Pumps H Generation onwards*

* Requires 1 PAW-AW-MBS-H per each Aquarea.



How Panasonic contributes to Nearly Zero Energy Buildings (nZEB)

Our expertise gained over the years has helped to launch a range of products that contribute to a more carbon-free society.

Panasonic is committed to develop products with greater energy efficiency.

Highly efficient Panasonic solutions can help to significantly reduce the energy consumption of the house, at the same time a high level of comfort and good indoor air quality are kept.

- Aquarea High performance heat pump for heating, cooling and domestic hot water production
- Aquarea Smart Cloud, for energy monitoring
- Heat recovery ventilation system
- PV panels to produce renewable energy on-site

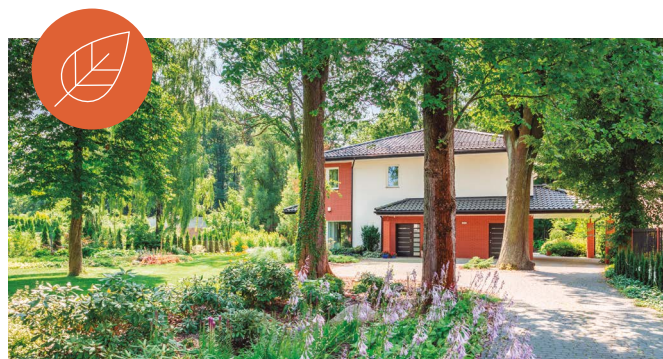

Aquarea Heat Pumps and the ventilation unit with heat recovery certified as Passive House Component

Aquarea High Performance All in One Compact and Bi-bloc J Generation heat pumps¹⁾ and the ventilation unit with heat recovery PAW-A2W-VENTA have been certified by the Passive House Institute (PHI) as Passive House Component. This certification ensures highly energy efficient components according to international criteria for respective thermal performance, comfort and indoor air quality.

1) 3, 5 and 7 kW models.

Certified models can be checked under the certification section of <https://database.passivehouse.com>.

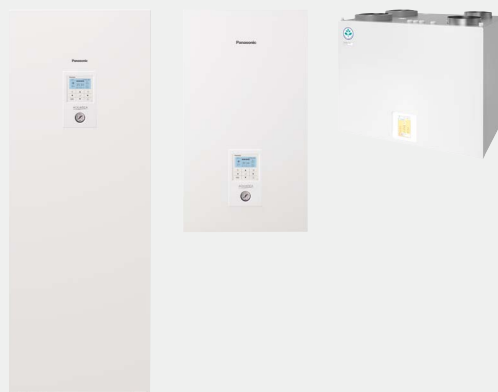

H3 Grande Passive House, Poland.

When looking for a energy-efficient heating solution, Polish construction company Procyon selected a 5 kW Panasonic Aquarea High Performance heat pump for its passive house project, H3 Grande. Procyon found this solution reduced annual heating expenses by almost half compared to an oil-based system, or by 10% in comparison to natural gas.

H3 Grande is a 175 m² detached house certified by the Passive House Institute (PHI) in Darmstadt. It is designed to minimise energy losses while incorporating an attractive, yet simple aesthetic. The building's shape, interior design and pitched roof contribute to the energy balance of the house, while large south-facing windows and wall insulation provide passive thermal comfort by retaining heat. The building has very low heating demand of approximately 15 W/m² and is designed to minimise energy.

Aquarea + PV panels

Aquarea Heat Pumps are designed with the future in mind. They can synchronise with PV panels with simple CZ-NS4P or CZ-NS5P PCB. Thanks to this feature, demand of heating, cooling and domestic hot water production is adapted to the PV panel production.

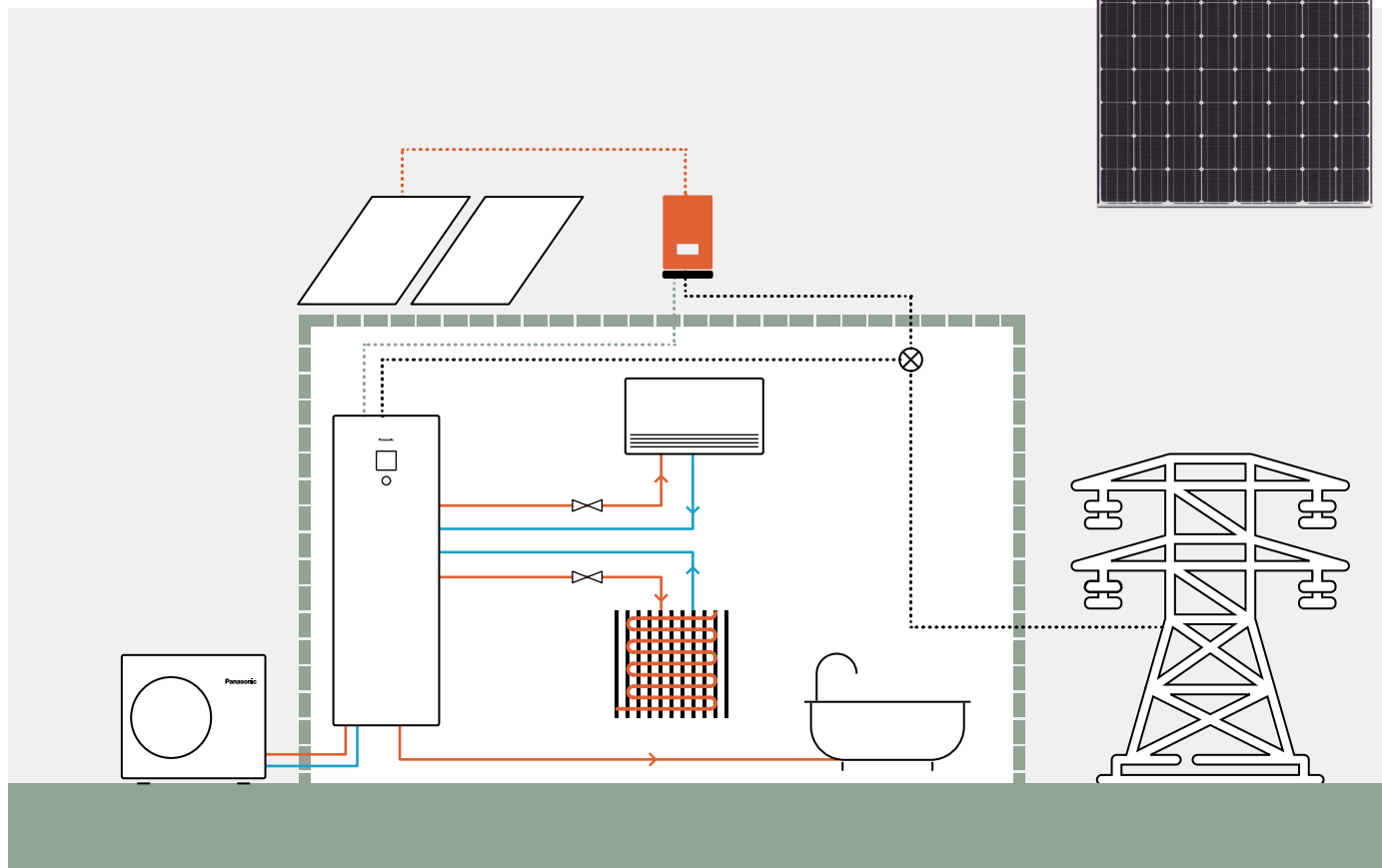

A part of converting Aquarea in Smart Grid ready, the additional PCB allows 0-10 V control, for an advanced energy management.



Turning a family home into an energy-neutral home with Panasonic air to water.

Sinne Technyk, installer, opts for Aquarea T-CAP heat pump combined with HIT KURO photovoltaic panels for a house in Oudemirdum in Friesland, the Netherlands. With this combination, the household enjoys energy-neutral and free heating, as well as domestic hot water, and benefit for a more comfortable indoor climate. The house had an annual gas consumption of 1800 to 2200 cubic meters per year. "The aim was to realize an energy-neutral home and reduce the usage of gas to zero," explains Leo van der Molen of Sinne Technyk. "That makes a heat pump an interesting option." With the comfort of the customers and neighbours in mind, a silent Aquarea T-CAP heat pump was chosen, powered by solar panels. A total of 24 Panasonic HIT KURO solar panels of 325 Wp each were installed. "The products of Panasonic are high end but offer a higher quality than other solutions. The price-quality ratio is, therefore, considerably better," says Van der Molen.

Panasonic PRO Club makes your life easier. All Aquarea Designer - online tool can be found there

Panasonic has an impressive range of support services for designers, specifiers, engineers and distributors working in air to water heat pump projects.



Energy Label

Fridges, dishwashers, washing machines, ovens – it all started with white goods in the 1990s. Today, other energy-consuming appliances also carry the European energy efficiency label, such as televisions and lighting. From 2013, the regulations applied to air conditioners and heat pumps but since September 2015, it has also been applicable to room heaters, water heaters and storage water heaters.

Minimum energy efficiency requirements are also specified for manufacturers of system and combi boilers, water heaters and DHW cylinders.

The purpose of Energy Labels are to assist consumers in their purchasing decisions, as well as ecodesign requirements on products which help reduce private energy demand and help to reduce global warming.

Panasonic helps you to calculate the system label.

From 26th September 2015, installers can be assured that all products manufactured after this date will be sold with the required energy efficiency labels which will aid installers with their paperwork. While it is the manufacturer's responsibility to issue their products with the required labels, the installers will need to calculate and issue an energy efficiency label for the entire heating system. Whether installing a new heating system or installing new boilers, controls or renewables into an existing system, it is, and will continue to be, the installer's responsibility to calculate and issue energy efficiency labels. Calculators which assist installers with this process are available on www.panasonicproclub.com.

Information on the energy efficiency label.

The rating system for heat pumps classifies them into seven efficiency categories. From 26th September 2019, the best energy efficiency category is A+++, least energy efficient is D. The energy efficiency label for system boilers shows its efficiency category on a scale from A+++ to D, and from A+ to F for hot water cylinders.

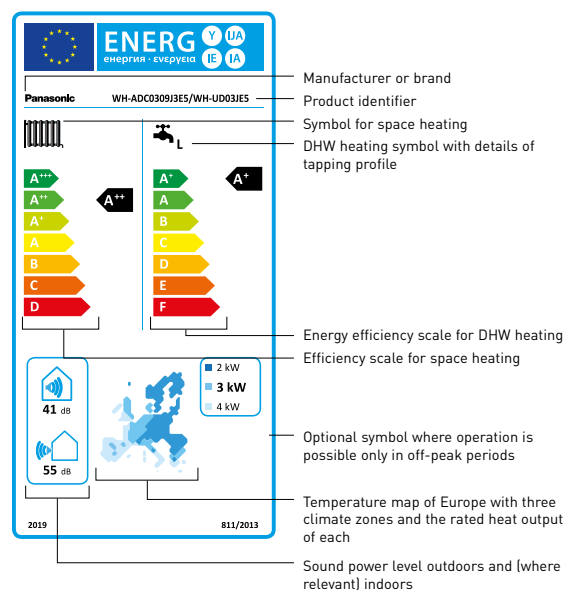

Panasonic helps you to calculate the system label www.panasonicproclub.com or connect simply with your smartphone to the PRO Club using this QR.

PRO Club 



Aquarea Designer - online tool

With Panasonic's online tool, projects can be developed simply and easily. The newly developed tool is optimised to help HVAC professionals easily identify the most appropriate Aquarea air to water heat pump for a particular application.

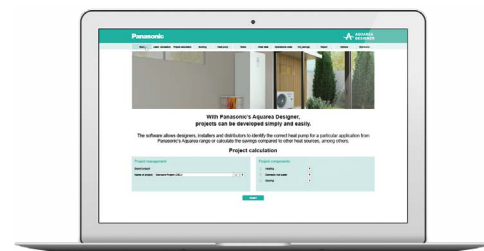

Aquarea Designer

This program allows HVAC designers, installers and distributors to identify the correct heat pump for a particular application from Panasonic's Aquarea range, calculate the savings compared to other heat sources and very quickly calculate CO₂ emissions.

Using Panasonic's Aquarea Designer, projects can be developed simply and easily, by either using the Quick Design or Expert Design options. Each allows the user to build up the project data in a simple step-by-step process and choose to output reports (project data input includes: either Quick or Large formats) as HTML files or as print-outs. To create these useful reports, project data is input, including:

- Heated area
- Heating requirement
- Heating flow and return temperatures
- Climate data (from a simple drop-down menu) including outdoor temperature
- Type of hot water tank, storage capacity and hot water target temperature



Hydraulic scheme generator

This tool allows costumers to select the scheme between more than 110 different type according to their installation requirements in a simple way. It possible to download hydraulic and electric part in pdf and in cad file. Moreover it is available a list, one for each scheme type, with the Panasonic codes and third party codes that the costumers need to realize the installation in a proper way.

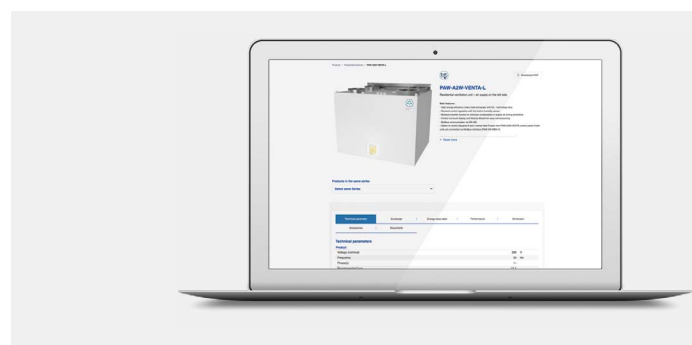
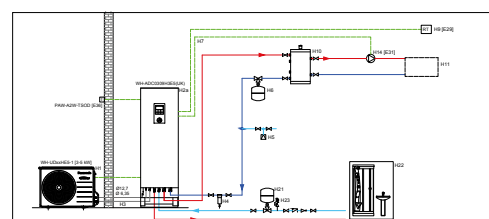

Residential ventilation selection tool.

The tool contains all the information the HVAC professionals need for their residential ventilation projects (specifications, technical manuals, etc.) as well as a calculator of the performance curves.

Heating demand calculator

This software can quickly and easily determine the heating requirements for the rooms in a project. The Heating demand calculator will help determine approximately how much power is needed to heat each room individually. The result in kilowatts will help you choose the space heater best suited to your needs.

CAD images and spec texts

In order to add value in the design of projects, Panasonic has a wide library of 2D CAD, BIM objects (Building Information Modeling) and Spec texts to be used in Revit.

All the support tools are available in Panasonic PRO Club (www.panasonicproclub.com).

Among many others, these are the main tools for the design of Aquarea projects.







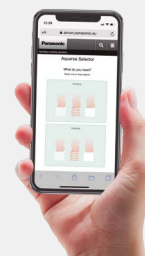













Try the new Panasonic Augmented Reality projector.



Helping you to find the Aquarea Heat Pump for your home in just a few clicks!



Aquarea Heat Pumps range

	3 kW	5 kW	7 kW	
Aquarea High Performance	Hydraulic split All in One 1ph P. 32	 <p>R290 NATURAL REFRIGERANT</p> <p>NEW WH-ADC0509L3E5UK ¹⁾ WH-WDG05LE5</p>	 <p>R290 NATURAL REFRIGERANT</p> <p>NEW WH-ADC0509L3E5UK ¹⁾ WH-WDG07LE5</p>	
	Hydraulic split Bi-bloc 1ph P. 33	 <p>R290 NATURAL REFRIGERANT</p> <p>NEW WH-SDC0509L3E5 ¹⁾ WH-WDG05LE5</p>	 <p>R290 NATURAL REFRIGERANT</p> <p>NEW WH-SDC0509L3E5 ¹⁾ WH-WDG07LE5</p>	
	All in One 1ph/3ph P. 34, 35	 <p>NEW WH-ADC0309K3E5UK ¹⁾¹⁾ WH-UDZ03KE5</p> <p>WH-ADC0309J3E5UK WH-UD03JE5</p>	 <p>NEW WH-ADC0309K3E5UK ¹⁾ WH-UDZ05KE5</p> <p>WH-ADC0309J3E5UK WH-UD05JE5</p>	 <p>NEW WH-ADC0309K3E5UK ¹⁾ WH-UDZ07KE5</p> <p>WH-ADC0309J3E5UK WH-UD07JE5</p>
	Bi-bloc 1ph/3ph P. 36, 37	 <p>NEW WH-SDC0309K3E5 ¹⁾²⁾ WH-UDZ03KE5 ²⁾</p> <p>WH-SDC0305J3E5 WH-UD03JE5</p>	 <p>NEW WH-SDC0309K3E5 ¹⁾²⁾ WH-UDZ05KE5 ²⁾</p> <p>WH-SDC0305J3E5 WH-UD05JE5</p>	 <p>NEW WH-SDC0309K3E5 ¹⁾²⁾ WH-UDZ07KE5 ²⁾</p> <p>WH-SDC0709J3E5 WH-UD07JE5</p>
	Mono-bloc 1ph P. 38, 39	 <p>WH-MDC05J3E5</p>	 <p>WH-MDC07J3E5</p>	
Aquarea T-CAP	All in One 1ph/3ph P. 40	 <p>NEW WH-ADC0912K6E5UK WH-UXZ09KE8 ²⁾</p>	 <p>NEW WH-ADC0912K6E5UK WH-UXZ12KE8 ²⁾</p>	
	Bi-bloc 1ph/3ph P. 41	 <p>NEW WH-SXC09K3E5 ¹⁾²⁾ WH-UXZ09KE5 ²⁾ WH-SXC09K3E8 ²⁾³⁾ WH-UXZ09KE8 ²⁾</p> <p>WH-SXC09H3E5 WH-UX09HE5</p>	 <p>NEW WH-SXC12K6E5 ²⁾ WH-UXZ12KE5 ²⁾ WH-SXC12K9E8 ²⁾ WH-UXZ12KE8 ²⁾</p> <p>WH-SXC12H6E5 WH-UQ12HE8</p>	 <p>WH-SXC16H9E8 WH-UX16HE8</p>
	Mono-bloc 1ph/3ph P. 42	 <p>WH-MXC09J3E5 WH-MXC09J3E8</p>	 <p>WH-MXC12J6E5 WH-MXC12J9E8</p>	 <p>WH-MXC16J9E8</p>

9 kW

12 kW

16 kW



NEW
WH-ADC0509L3E5UK ¹⁾
WH-WDG09LE5



NEW
WH-SDC0509L3E5 ¹⁾
WH-WDG09LE5



NEW
WH-ADC0309K3E5UK ¹⁾
WH-UDZ09KE5



NEW
WH-SDC0309K3E5 ^{1) 2)}
WH-UDZ09KE5 ²⁾

WH-SDC0709J3E5
WH-UD09JE5-1



WH-MDC09J3E5



WH-MDC12H6E5

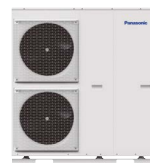

WH-MDC16H6E5

NEW Aquarea High Performance Hydraulic Split All in One L Generation Single phase. Heating and Cooling - R290

Natural refrigerant R290 with GWP 3.

Energy efficiency: A+++ in heating at 35 °C and A+ in DHW / DHW up to 65 °C without heater / Stainless steel DHW tank with U-Vacua™ insulation panel / DHW COP up to 3,60.

Flexibility: Hydraulic connection between indoor and outdoor / Built-in magnetic water filter.

Comfort: Operation without backup heating at -25 °C / 75 °C water outlet temperature maximum at -10 °C outside temperature / 55 °C hot water even at -25 °C outside temperature.

Control: Optimised user interface and improved features [2 zone control, bivalent control].

Connectivity: Wi-Fi adapter included.



				Single phase (power to indoor)		
Kit 3 kW electric heater			KIT-ADC05L3E5UK	KIT-ADC07L3E5UK	KIT-ADC09L3E5UK	
Heating capacity / COP (A +7 °C, W 35 °C)	kW / COP		5,00/5,05	7,00/4,93	9,00/4,55	
Heating capacity / COP (A +7 °C, W 55 °C)	kW / COP		5,00/3,07	7,00/2,98	8,90/3,03	
Heating capacity / COP (A +2 °C, W 35 °C)	kW / COP		5,00/3,52	6,85/3,43	7,00/3,41	
Heating capacity / COP (A +2 °C, W 55 °C)	kW / COP		5,00/2,34	6,25/2,34	7,00/2,41	
Heating capacity / COP (A -7 °C, W 35 °C)	kW / COP		5,00/3,01	5,80/3,01	7,00/2,80	
Heating capacity / COP (A -7 °C, W 55 °C)	kW / COP		5,00/2,12	5,80/2,12	7,00/2,13	
Cooling capacity / EER (A 35 °C, W 7 °C)	kW / EER		5,00/3,23	7,00/3,03	8,20/2,82	
Cooling capacity / EER (A 35 °C, W 18 °C)	kW / EER		5,00/5,00	7,00/4,73	9,00/4,19	
Heating average climate (W 35 °C / W 55 °C)	Seasonal energy efficiency	SCOP (η _s %)	5,06/3,63(200/142)	4,96/3,62(195/142)	4,84/3,67(190/144)	
	Energy class ¹⁾		A+++ to D	A+++/A++	A+++/A++	
Heating warm climate (W 35 °C / W 55 °C)	Seasonal energy efficiency	SCOP (η _s %)	6,00/4,27(237/168)	6,31/4,52(249/178)	6,44/4,50(255/177)	
	Energy class ¹⁾		A+++ to D	A+++/A+++	A+++/A+++	
Heating cold climate (W 35 °C / W 55 °C)	Seasonal energy efficiency	SCOP (η _s %)	4,25/3,28(167/128)	4,25/3,29(167/129)	4,31/3,33(170/130)	
	Energy class ¹⁾		A+++ to D	A++/A++	A++/A++	
Indoor unit 3 kW electric heater			WH-ADC0509L3E5UK	WH-ADC0509L3E5UK	WH-ADC0509L3E5UK	
Sound pressure	Heat / Cool	dB(A)	28/28	28/28	28/28	
Dimension	HxWxD	mm	1642x599x602	1642x599x602	1642x599x602	
Net weight 3 kW / 6 kW		kg	93/94	93/94	93/94	
Water pipe connector	Room	Inch	1½	1½	1½	
	Shower	Inch	¾	¾	¾	
A class pump	Number of speeds		Variable Speed	Variable Speed	Variable Speed	
	Input power (Min/Max)	W	30/145	30/145	30/145	
Heating water flow (ΔT=5 K, 35 °C)		L/min	14,3	20,1	25,8	
Water volume		L	185	185	185	
Maximum DHW temperature		°C	65	65	65	
Material inside tank			Stainless steel	Stainless steel	Stainless steel	
Tapping profile according EN16147			L	L	L	
DHW tank ERP efficiency average / warm / cold ²⁾		A+ to F	A+/A+/A	A+/A+/A	A+/A+/A	
DHW tank ERP average climate η / COP _{DHW}	η _{wh} % / COP _{DHW}		146/3,60	146/3,60	146/3,60	
DHW tank ERP warm climate η / COP _{DHW}	η _{wh} % / COP _{DHW}		160/4,00	160/4,00	160/4,00	
DHW tank ERP cold climate η / COP _{DHW}	η _{wh} % / COP _{DHW}		112/2,80	112/2,80	112/2,80	
Outdoor unit			WH-WDG05LE5	WH-WDG07LE5	WH-WDG09LE5	
Sound power ³⁾	Heat	dB(A)	52	53	54	
Dimension / Net weight	HxWxD	mm / kg	996x980x430/98	996x980x430/98	996x980x430/97	
Refrigerant (R290) / CO ₂ Eq.		kg / T	0,96/0,003	0,96/0,003	1,00/0,003	
Water pipe connector (indoor / outdoor units)		Inch	1/1	1/1	1/1	
Pipe length range standard / maximum		m	5/30	5/30	5/30	
Elevation difference (in / out)		m	10	10	10	
Operating range - outdoor ambient	Heat	°C	-25 ~ +35	-25 ~ +35	-25 ~ +35	
	Cool	°C	+10 ~ +43	+10 ~ +43	+10 ~ +43	
Water outlet	Heat / Cool	°C	20 ~ 75/5 ~ 20	20 ~ 75/5 ~ 20	20 ~ 75/5 ~ 20	

Electrical information		3 kW heater	6 kW heater	3 kW heater	6 kW heater	3 kW heater	6 kW heater
Electric backup heater	kW	3,00	6,00	3,00	6,00	3,00	6,00
Recommended RCD, supply 1 / 2	A	25/16	25/30	25/16	25/30	25/16	25/30
Recommended minimum cable size, supply 1 / 2 ⁴⁾	mm ²	3x2,5/3x1,5	3x2,5/3x4,0	3x2,5/3x1,5	3x2,5/3x4,0	3x2,5/3x1,5	3x2,5/3x4,0

1) Scale from A+++ to D. 2) Scale from A+ to F. 3) The sound power level is measured with accordance to EN12102 under conditions of the EN14825 (part load). 4) Check local regulations. * EER and COP calculation is based in accordance to EN14511. ** This product is designed to comply with the European Water Quality Directive 98/83/EC amended by 2015/1787/EU. The lifespan of the product is not guaranteed in the case of the use of groundwater, such as spring water or well water, the use of tap water when salt or other impurities are contained, nor in areas of acidic water quality. Maintenance and warranty costs related to these cases are the customer's responsibility.

Accessories	
CZ-RTW1	Additional remote controller for K and L Generations
CZ-NS5P	Additional functions PCB
PAW-A2W-RTWIRED	Room thermostat

Accessories	
PAW-A2W-RTWIREDLESS	Wireless LCD room thermostat
PAW-A2W-AFVLY	1 anti-freeze valve. It is required to order 2 valves per system



INTERNET CONTROL: Wi-Fi adapter included.

NEW Aquarea High Performance Hydraulic Split Bi-bloc L Generation Single phase. Heating and Cooling · R290

Natural refrigerant R290 with GWP 3.

Energy efficiency: A+++ in heating at 35 °C / Built-in flow meter.

Flexibility: Hydraulic connection between indoor and outdoor / Built-in magnetic water filter / Installation possible in sites with harsh water quality.

Comfort: Operation without backup heating at -25 °C / 75 °C water outlet temperature maximum at -10 °C outside temperature / 55 °C hot water even at -25 °C outside temperature.

Control: Optimised user interface and improved features (2 zone control, bivalent control).

Connectivity: Wi-Fi adapter included.



Tentative data

			Single phase (power to indoor)					
Kit 3 kW electric heater			KIT-WC05L3E5	KIT-WC07L3E5	KIT-WC09L3E5			
Heating capacity / COP (A +7 °C, W 35 °C)		kW / COP	5,00/5,05	7,00/4,93	9,00/4,55			
Heating capacity / COP (A +7 °C, W 55 °C)		kW / COP	5,00/3,07	7,00/2,98	8,90/3,03			
Heating capacity / COP (A +2 °C, W 35 °C)		kW / COP	5,00/3,52	6,85/3,43	7,00/3,41			
Heating capacity / COP (A +2 °C, W 55 °C)		kW / COP	5,00/2,34	6,25/2,34	7,00/2,41			
Heating capacity / COP (A -7 °C, W 35 °C)		kW / COP	5,00/3,01	5,80/3,01	7,00/2,80			
Heating capacity / COP (A -7 °C, W 55 °C)		kW / COP	5,00/2,12	5,80/2,12	7,00/2,13			
Cooling capacity / EER (A 35 °C, W 7 °C)		kW / EER	5,00/3,23	7,00/3,03	8,20/2,82			
Cooling capacity / EER (A 35 °C, W 18 °C)		kW / EER	5,00/5,00	7,00/4,73	9,00/4,19			
Heating average climate (W 35 °C / W 55 °C)	Seasonal energy efficiency	SCOP (η _s %)	5,06/3,63(200/142)	4,96/3,62(195/142)	4,84/3,67(190/144)			
	Energy class ¹⁾		A+++ to D	A+++ to A++	A+++ to A++			
Heating warm climate (W 35 °C / W 55 °C)	Seasonal energy efficiency	SCOP (η _s %)	6,00/4,27(237/168)	6,31/4,52(249/178)	6,44/4,50(255/177)			
	Energy class ¹⁾		A+++ to D	A+++ to A+++	A+++ to A+++			
Heating cold climate (W 35 °C / W 55 °C)	Seasonal energy efficiency	SCOP (η _s %)	4,25/3,28(167/128)	4,25/3,29(167/129)	4,31/3,33(170/130)			
	Energy class ¹⁾		A+++ to D	A++ to A++	A++ to A++			
Indoor unit 3 kW electric heater			WH-SDC0509L3E5	WH-SDC0509L3E5	WH-SDC0509L3E5			
Sound pressure	Heat / Cool	dB(A)	28/28	30/30	30/31			
Dimension	H x W x D	mm	892 x 500 x 348	892 x 500 x 348	892 x 500 x 348			
Net weight		kg	—	—	—			
Water pipe connector	Room	Inch	R 1/4	R 1/4	R 1/4			
A class pump	Number of speeds		Variable Speed	Variable Speed	Variable Speed			
	Input power (Min/Max)	W	30/145	30/145	30/145			
Heating water flow (ΔT=5 K, 35 °C)		L/min	—	—	—			
Outdoor unit			WH-WDG05LE5	WH-WDG07LE5	WH-WDG09LE5			
Sound power ²⁾	Heat	dB(A)	52	53	54			
Dimension	H x W x D	mm	996 x 980 x 430	996 x 980 x 430	996 x 980 x 430			
Net weight		kg	98	98	97			
Refrigerant (R290) / CO ₂ Eq.		kg / T	0,96/0,003	0,96/0,003	1,00/0,003			
Water pipe connector (indoor / outdoor units)		Inch	1/1	1/1	1/1			
Pipe length range standard / maximum		m	5/30	5/30	5/30			
Elevation difference (in / out)		m	10	10	10			
Operating range - outdoor ambient	Heat	°C	-25 ~ +35	-25 ~ +35	-25 ~ +35			
	Cool	°C	+10 ~ +43	+10 ~ +43	+10 ~ +43			
Water outlet	Heat / Cool	°C	20 ~ 75/5 ~ 20	20 ~ 75/5 ~ 20	20 ~ 75/5 ~ 20			
Electrical information			3 kW heater	6 kW heater	3 kW heater	6 kW heater	3 kW heater	6 kW heater
Electric backup heater		kW	3,00	6,00	3,00	6,00	3,00	6,00
Recommended fuse		A	25/16	25/30	25/16	25/30	25/16	25/30
Recommended minimum cable size, supply 1 / 2 ³⁾		mm ²	3x2,5/3x1,5	3x2,5/3x4,0	3x2,5/3x1,5	3x2,5/3x4,0	3x2,5/3x1,5	3x2,5/3x4,0

1) Scale from A+++ to D. 2) The sound power level is measured with accordance to EN12102 under conditions of the EN14825 (part load). 3) Check local regulations. * EER and COP calculation is based in accordance to EN14511. ** This product is designed to comply with the European Water Quality Directive 98/83/EC amended by 2015/1787/EU. The lifespan of the product is not guaranteed in the case of the use of groundwater, such as spring water or well water, the use of tap water when salt or other impurities are contained, nor in areas of acidic water quality. Maintenance and warranty costs related to these cases are the customer's responsibility. *** Tentative data.

Accessories	
CZ-RTW1	Additional remote controller for K and L Generations
PAW-TD20C1E5-1	Tank 200 L - Stainless steel
PAW-TD30C1E5-1	Tank 300 L - Stainless steel
PAW-TA20C1E5STD	Tank 200 L - Enamelled
PAW-TA30C1E5STD	Tank 300 L - Enamelled
PAW-3WYVLV-HW	3 way valve for DHW tanks
CZ-NV2	3 way valve kit for inside of hydrokit for K and L Generations

Accessories	
PAW-BTANK50L-2	Buffer tank 50 L
CZ-NS5P	Additional functions PCB
PAW-A2W-RTWIRED	Room thermostat
PAW-A2W-RTWIREDLESS	Wireless LCD room thermostat
PAW-A2W-AFVLV	1 anti-freeze valve. It is required to order 2 valves per system



INTERNET CONTROL: Wi-Fi adapter included.

NEW Aquarea High Performance All in One K Generation Single phase. Heating and Cooling - R32

Energy efficiency: COP up to 5,33 / A+++ in heating at 35 °C and A+ in DHW / "A" water pump with variable speed / Stainless steel DHW tank with U-Vacua™ insulation panel / DHW COP up to 3,50.

Flexibility: 598 x 600 footprint / Easy access to hydraulic parts / Built-in magnetic water filter.

Comfort: Operation without backup heating at -25 °C / 60 °C hot water even at -10 °C outside temperature.

Control: Optimised user interface and improved features [2 zone control, bivalent control].

Connectivity: Optional Aquarea Smart and Service Cloud and integration into BMS projects.



		Single phase (power to indoor)				
Kit 3 kW electric heater		KIT-ADC03K3E5UK	KIT-ADC05K3E5UK	KIT-ADC07K3E5UK	KIT-ADC09K3E5UK	
Heating capacity / COP (A +7 °C, W 35 °C)	kW / COP	3,20/5,33	5,00/5,10	7,00/4,86	9,00/4,55	
Heating capacity / COP (A +7 °C, W 55 °C)	kW / COP	— / —	5,00/3,03	7,00/2,92	8,90/2,93	
Heating capacity / COP (A +2 °C, W 35 °C)	kW / COP	3,20/3,64	5,00/3,57	6,85/3,43	7,00/3,40	
Heating capacity / COP (A +2 °C, W 55 °C)	kW / COP	— / —	5,00/2,29	6,25/2,23	6,30/2,18	
Heating capacity / COP (A -7 °C, W 35 °C)	kW / COP	— / —	5,00/2,79	5,75/2,95	6,25/2,84	
Heating capacity / COP (A -7 °C, W 55 °C)	kW / COP	— / —	5,00/1,89	5,35/1,98	5,90/1,93	
Cooling capacity / EER (A 35 °C, W 7 °C)	kW / EER	3,20/3,52	5,00/3,05	6,70/3,03	8,20/2,72	
Cooling capacity / EER (A 35 °C, W 18 °C)	kW / EER	— / —	5,00/4,90	6,70/4,72	9,00/4,18	
Heating average climate (W 35 °C / W 55 °C)	Seasonal energy efficiency	SCOP (η _s %)	5,07/3,47(200/136)	5,12/3,63(202/142)	4,90/3,62(193/142)	4,44/3,41(175/133)
	Energy class ¹⁾		A+++ / A++	A+++ / A++	A+++ / A++	A+++ / A++
Heating warm climate (W 35 °C / W 55 °C)	Seasonal energy efficiency	SCOP (η _s %)	6,20/4,20(245/165)	6,00/4,20(237/165)	5,75/4,07(227/160)	5,75/4,07(227/160)
	Energy class ¹⁾		A+++ / A+++	A+++ / A+++	A+++ / A+++	A+++ / A+++
Heating cold climate (W 35 °C / W 55 °C)	Seasonal energy efficiency	SCOP (η _s %)	4,00/2,83(157/110)	4,08/2,95(160/115)	4,18/2,98(164/116)	4,18/2,98(164/116)
	Energy class ¹⁾		A++ / A+	A++ / A+	A++ / A+	A++ / A+
Indoor unit 3 kW electric heater		WH-ADC0309K3E5	WH-ADC0309K3E5	WH-ADC0309K3E5	WH-ADC0309K3E5	
Sound pressure	Heat / Cool	dB(A)	28/28	28/28	28/28	
Dimension	H x W x D	mm	1642 x 599 x 602	1642 x 599 x 602	1642 x 599 x 602	
Net weight 3 kW / 6 kW		kg	100/101	100/101	100/101	
Water pipe connector		Inch	R 1 1/4	R 1 1/4	R 1 1/4	
A class pump	Number of speeds		Variable Speed	Variable Speed	Variable Speed	
	Input power (Min/Max)	W	30/120	30/120	30/120	
Heating water flow (ΔT=5 K, 35 °C)		L/min	9,2	14,3	20,1	
Water volume		L	185	185	185	
Maximum DHW temperature		°C	65	65	65	
Material inside tank			Stainless steel	Stainless steel	Stainless steel	
Tapping profile according EN16147			L	L	L	
DHW tank ERP efficiency average / warm / cold ²⁾		A+ to F	A+ / A++ / A	A+ / A++ / A	A+ / A++ / A	
DHW tank ERP average climate η / COPdHW	η _{wh} % / COPdHW		128/3,20	140/3,50	140/3,50	
DHW tank ERP warm climate η / COPdHW	η _{wh} % / COPdHW		154/3,86	160/4,00	160/4,00	
DHW tank ERP cold climate η / COPdHW	η _{wh} % / COPdHW		99/2,48	112/2,80	112/2,80	
Outdoor unit		WH-UDZ03KE5	WH-UDZ05KE5	WH-UDZ07KE5	WH-UDZ09KE5	
Sound power ³⁾	Heat	dB(A)	55	55	56	
Dimension / Net weight	H x W x D	mm / kg	622 x 824 x 298/37	795 x 875 x 320/55	795 x 875 x 320/55	
Refrigerant (R32) / CO ₂ Eq.		kg / T	0,9/0,608	1,3/0,878	1,3/0,878	
Piping diameter	Liquid / Gas	Inch (mm)	1/4 (6,35) / 1/2 (12,70)	1/4 (6,35) / 5/8 (15,88)	1/4 (6,35) / 5/8 (15,88)	
Pipe length range / Elevation difference (in / out)		m / m	3-25/20	3-40 (3-50) ⁴⁾ / 30	3-40 (3-50) ⁴⁾ / 30	
Pre-charged pipe length / Additional gas amount		m / g/m	10/20	10/25	10/25	
Operating range - outdoor ambient	Heat	°C	-20 ~ +35	-25 ~ +35	-25 ~ +35	
	Cool	°C	+10 ~ +43	+10 ~ +43	+10 ~ +43	
Water outlet	Heat / Cool	°C	20 ~ 60/5 ~ 20	20 ~ 60/5 ~ 20	20 ~ 60/5 ~ 20	

Electrical information		3 kW heater	6 kW heater	3 kW heater	6 kW heater	3 kW heater	6 kW heater	3 kW heater	6 kW heater
Electric backup heater	kW	3,00	6,00	3,00	6,00	3,00	6,00	3,00	6,00
Recommended fuse	A	16/16	16/30	16/16	16/30	25/16	25/30	25/16	25/30
Recommended minimum cable size, supply 1 / 2 ⁵⁾	mm ²	3x1,5/3x1,5	3x1,5/3x4,0	3x1,5/3x1,5	3x1,5/3x4,0	3x2,5/3x1,5	3x2,5/3x4,0	3x2,5/3x1,5	3x2,5/3x4,0

1) Scale from A+++ to D. 2) Scale from A+ to F. 3) Sound power in accordance to 811/2013, 813/2013 and EN12102-1:2017 at +7 °C. 4) Operation range down to -25 °C in heating with 3-40 m pipe length range, operation range down to -15 °C in heating with 3-50 m pipe length range. 5) Check local regulations. * EER and COP calculation is based in accordance to EN14511. ** This product is designed to comply with the European Water Quality Directive 98/83/EC amended by 2015/1787/EU. The lifespan of the product is not guaranteed in the case of the use of groundwater, such as spring water or well water, the use of tap water when salt or other impurities are contained, nor in areas of acidic water quality. Maintenance and warranty costs related to these cases are the customer's responsibility.

Accessories	
CZ-RTW1	Additional remote controller for K and L Generations
CZ-TAW1B	Aquarea Smart Cloud for remote control and maintenance through wireless or wired LAN
CZ-TAW1-CBL	10 m extension cable for CZ-TAW1B

Accessories	
CZ-NS5P	Additional functions PCB
PAW-A2W-RTWIRED	Room thermostat
PAW-A2W-RTWIRELESS	Wireless LCD room thermostat



INTERNET CONTROL: Optional.

Aquarea High Performance All in One J Generation Single phase. Heating and Cooling - R32

Energy efficiency: COP up to 5,33 / A+++ in heating at 35 °C and A+ in DHW / "A" water pump with variable speed / Stainless steel DHW tank with U-Vacua™ insulation panel / Built-in flow meter.

Flexibility: Long piping lengths / Built-in magnetic water filter.

Comfort: Heating curve down to -20 °C / 60 °C water outlet temperature.

Control: Additional functions with optional PCB (2 zone control, bivalent control, Smart Grid contact and more).

Connectivity: Optional Aquarea Smart and Service Cloud and integration into BMS projects.



Single phase (power to indoor)					
Kit		KIT-ADC03JE5UK	KIT-ADC05JE5UK	KIT-ADC07JE5UK	
Heating capacity / COP (A +7 °C, W 35 °C)	kW / COP	3,20/5,33	5,00/5,00	7,00/4,76	
Heating capacity / COP (A +7 °C, W 55 °C)	kW / COP	3,20/2,81	5,00/2,72	7,00/2,82	
Heating capacity / COP (A +2 °C, W 35 °C)	kW / COP	3,20/3,64	4,20/3,18	6,85/3,41	
Heating capacity / COP (A +2 °C, W 55 °C)	kW / COP	3,20/2,19	4,10/1,99	6,20/2,21	
Heating capacity / COP (A -7 °C, W 35 °C)	kW / COP	3,30/2,80	4,20/2,59	5,60/2,87	
Heating capacity / COP (A -7 °C, W 55 °C)	kW / COP	3,20/1,79	3,55/1,71	5,25/1,94	
Cooling capacity / EER (A 35 °C, W 7 °C)	kW / EER	3,20/3,52	4,50/3,00	6,70/3,03	
Cooling capacity / EER (A 35 °C, W 18 °C)	kW / EER	3,20/4,71	4,80/4,29	6,70/4,72	
Heating average climate (W 35 °C / W 55 °C)	Seasonal energy efficiency	SCOP (η _s %)	5,07/3,47(200/136)	5,07/3,47(200/136)	4,90/3,32(193/130)
	Energy class ¹⁾	A+++ to D	A+++ / A++	A+++ / A++	A+++ / A++
Heating warm climate (W 35 °C / W 55 °C)	Seasonal energy efficiency	SCOP (η _s %)	6,20/4,20(245/165)	6,20/4,20(245/165)	5,75/4,07(227/160)
	Energy class ¹⁾	A+++ to D	A+++ / A+++	A+++ / A+++	A+++ / A+++
Heating cold climate (W 35 °C / W 55 °C)	Seasonal energy efficiency	SCOP (η _s %)	4,00/2,83(157/110)	4,00/2,83(157/110)	4,18/2,98(164/116)
	Energy class ¹⁾	A+++ to D	A++ / A+	A++ / A+	A++ / A+
Indoor unit			WH-ADC0309J3E5UK	WH-ADC0309J3E5UK	WH-ADC0309J3E5UK
Sound pressure	Heat / Cool	dB(A)	28/28	28/28	28/28
Dimension	H x W x D	mm	1800 x 598 x 717	1800 x 598 x 717	1800 x 598 x 717
Net weight 1 zone / 2 zones		kg	122/130	122/130	122/130
Water pipe connector		Inch	R 1 1/4	R 1 1/4	R 1 1/4
A class pump	Number of speeds		Variable Speed	Variable Speed	Variable Speed
	Input power (Min/Max)	W	30/120	30/120	30/120
Heating water flow (ΔT=5 K, 35 °C)		L/min	9,20	14,30	20,10
Electric backup heater		kW	3,00	3,00	3,00
Recommended fuse		A	16/16	16/16	25/16
Recommended minimum cable size, supply 1 / 2 ²⁾		mm ²	3 x 1,5 / 3 x 1,5	3 x 1,5 / 3 x 1,5	3 x 2,5 / 3 x 1,5
Water volume		L	185	185	185
Maximum DHW temperature		°C	65	65	65
Material inside tank			Stainless steel	Stainless steel	Stainless steel
Tapping profile according EN16147			L	L	L
DHW tank ERP efficiency average / warm / cold ³⁾		A+ to F	A+ / A+ / A	A+ / A+ / A	A+ / A+ / A
DHW tank ERP average climate η / COPdHW		η _{wh} % / COPdHW	132/3,30	132/3,30	120/3,00
DHW tank ERP warm climate η / COPdHW		η _{wh} % / COPdHW	155/3,88	155/3,88	140/3,50
DHW tank ERP cold climate η / COPdHW		η _{wh} % / COPdHW	99/2,48	99/2,48	99/2,47
Outdoor unit			WH-UD03JE5	WH-UD05JE5	WH-UD07JE5
Sound power ⁴⁾	Heat	dB(A)	55	55	59
Dimension / Net weight	H x W x D	mm / kg	622 x 824 x 298 / 37	622 x 824 x 298 / 37	795 x 875 x 320 / 61
Refrigerant (R32) / CO ₂ Eq.		kg / T	0,9/0,608	0,9/0,608	1,27/0,857
Piping diameter	Liquid / Gas	Inch (mm)	1/4 (6,35) / 1/2 (12,70)	1/4 (6,35) / 1/2 (12,70)	1/4 (6,35) / 5/8 (15,88)
Pipe length range / Elevation difference (in / out)		m / m	3 - 25/20	3 - 25/20	3 - 50/30
Pre-charged pipe length / Additional gas amount		m / g/m	10/20	10/20	10/25
Operating range - outdoor ambient	Heat	°C	-20 ~ +35	-20 ~ +35	-20 ~ +35
	Cool	°C	+10 ~ +43	+10 ~ +43	+10 ~ +43
Water outlet	Heat / Cool	°C	20 ~ 60/5 ~ 20	20 ~ 60/5 ~ 20	20 ~ 60/5 ~ 20

1) Scale from A+++ to D. 2) Check local regulations. 3) Scale from A+ to F. 4) Sound power in accordance to 811/2013, 813/2013 and EN12102-1:2017 at +7 °C. * EER and COP calculation is based in accordance to EN14511. ** This product is designed to comply with the European Water Quality Directive 98/83/EC amended by 2015/1787/EU. The lifespan of the product is not guaranteed in the case of the use of groundwater, such as spring water or well water, the use of tap water when salt or other impurities are contained, nor in areas of acidic water quality. Maintenance and warranty costs related to these cases are the customer's responsibility.

Accessories	
PAW-ADC-PREKIT-1	Piping pre installation kit for J Generation
CZ-TAW1B	Aquarea Smart Cloud for remote control and maintenance through wireless or wired LAN
CZ-TAW1-CBL	10 m extension cable for CZ-TAW1B

Accessories	
CZ-NS4P	Additional functions PCB
PAW-A2W-RTWIRED	Room thermostat
PAW-A2W-RTWIRELESS	Wireless LCD room thermostat



INTERNET CONTROL: Optional.

NEW Aquarea High Performance Bi-bloc K Generation Single phase. Heating and Cooling - SDC · R32

Energy efficiency: COP up to 5,33 / A+++ in heating at 35 °C / "A" water pump with variable speed / Built-in flow meter.

Flexibility: Long piping lengths / Built-in magnetic water filter.

Comfort: Operation without backup heating at -25 °C / 60 °C hot water even at -10 °C outside temperature.

Control: Optimised user interface and improved features (2 zone control, bivalent control).

Connectivity: Optional Aquarea Smart and Service Cloud and integration into BMS projects.



Tentative data

			Single phase [power to indoor]			
Kit 3 kW electric heater			KIT-WC03K3E5	KIT-WC05K3E5	KIT-WC07K3E5	KIT-WC09K3E5
Heating capacity / COP (A +7 °C, W 35 °C)	kW / COP		3,20/5,33	5,00/5,10	7,00/4,86	9,00/4,55
Heating capacity / COP (A +7 °C, W 55 °C)	kW / COP		3,20/2,81	5,00/3,03	7,00/2,92	8,90/2,93
Heating capacity / COP (A +2 °C, W 35 °C)	kW / COP		3,20/3,64	5,00/3,57	6,85/3,43	7,00/3,40
Heating capacity / COP (A +2 °C, W 55 °C)	kW / COP		3,20/2,19	5,00/2,29	6,25/2,23	6,30/2,18
Heating capacity / COP (A -7 °C, W 35 °C)	kW / COP		3,30/2,80	5,00/2,79	5,75/2,95	6,25/2,84
Heating capacity / COP (A -7 °C, W 55 °C)	kW / COP		3,20/1,79	5,00/1,89	5,35/1,98	5,90/1,93
Cooling capacity / EER (A 35 °C, W 7 °C)	kW / EER		3,20/3,52	5,00/3,05	6,70/3,03	8,20/2,72
Cooling capacity / EER (A 35 °C, W 18 °C)	kW / EER		3,20/4,71	5,00/4,90	6,70/4,72	9,00/4,18
Heating average climate (W 35 °C / W 55 °C)	Seasonal energy efficiency	SCOP (η _s %)	5,07/3,47(200/136)	5,12/3,63(202/142)	4,90/3,62(193/142)	4,44/3,41(175/133)
	Energy class ¹⁾		A+++ / A++	A+++ / A++	A+++ / A++	A+++ / A++
Heating warm climate (W 35 °C / W 55 °C)	Seasonal energy efficiency	SCOP (η _s %)	6,20/4,20(245/165)	6,00/4,20(237/165)	5,75/4,07(227/160)	5,75/4,07(227/160)
	Energy class ¹⁾		A+++ / A+++	A+++ / A+++	A+++ / A+++	A+++ / A+++
Heating cold climate (W 35 °C / W 55 °C)	Seasonal energy efficiency	SCOP (η _s %)	4,00/2,83(157/110)	4,08/2,95(160/115)	4,18/2,98(164/116)	4,18/2,98(164/116)
	Energy class ¹⁾		A+++ to D	A++ / A+	A++ / A+	A++ / A+
Indoor unit 3 kW electric heater			WH-SDC0309K3E5	WH-SDC0309K3E5	WH-SDC0309K3E5	WH-SDC0309K3E5
Sound pressure	Heat / Cool	dB(A)	28/28	28/28	30/30	30/31
Dimension	H x W x D	mm	892 x 500 x 348	892 x 500 x 348	892 x 500 x 348	892 x 500 x 348
Net weight		kg	—	—	—	—
Water pipe connector		Inch	R 1 1/4	R 1 1/4	R 1 1/4	R 1 1/4
A class pump	Number of speeds		Variable Speed	Variable Speed	Variable Speed	Variable Speed
	Input power (Min/Max)	W	30/120	30/120	30/120	30/120
Heating water flow (ΔT=5 K, 35 °C)		L/min	9,2	14,3	20,1	25,8
Outdoor unit			WH-UDZ03KE5	WH-UDZ05KE5	WH-UDZ07KE5	WH-UDZ09KE5
Sound power ²⁾	Heat	dB(A)	55	55	56	56
Dimension	H x W x D	mm	622 x 824 x 298	795 x 875 x 320	795 x 875 x 320	795 x 875 x 320
Net weight		kg	37	55	55	55
Refrigerant (R32) / CO ₂ Eq.		kg / T	0,9/0,608	1,3/0,878	1,3/0,878	1,3/0,878
Piping diameter	Liquid / Gas	Inch (mm)	1/4(6,35)/1/2(12,70)	1/4(6,35)/5/8(15,88)	1/4(6,35)/5/8(15,88)	1/4(6,35)/5/8(15,88)
Pipe length range		m	3 ~ 25	3 ~ 40 [3 ~ 50] ³⁾	3 ~ 40 [3 ~ 50] ³⁾	3 ~ 40 [3 ~ 50] ³⁾
Elevation difference (in / out)		m	20	30	30	30
Pre-charged pipe length		m	10	10	10	10
Additional gas amount		g/m	20	25	25	25
Operating range - outdoor ambient	Heat	°C	-20 ~ +35	-25 ~ +35	-25 ~ +35	-25 ~ +35
	Cool	°C	+10 ~ +43	+10 ~ +43	+10 ~ +43	+10 ~ +43
Water outlet	Heat / Cool	°C	20 ~ 60/5 ~ 20	20 ~ 60/5 ~ 20	20 ~ 60/5 ~ 20	20 ~ 60/5 ~ 20

Electrical information		3 kW heater	6 kW heater	3 kW heater	6 kW heater	3 kW heater	6 kW heater	3 kW heater	6 kW heater
Electric backup heater	kW	3,00	6,00	3,00	6,00	3,00	6,00	3,00	6,00
Recommended fuse	A	16/16	16/30	16/16	16/30	25/16	25/30	25/16	25/30
Recommended minimum cable size, supply 1 / 2 ⁴⁾	mm ²	3x1,5/3x1,5	3x1,5/3x4,0	3x1,5/3x1,5	3x1,5/3x4,0	3x2,5/3x1,5	3x2,5/3x4,0	3x2,5/3x1,5	3x2,5/3x4,0

1) Scale from A+++ to D. 2) Sound power in accordance to 811/2013, 813/2013 and EN12102-1:2017 at +7 °C. 3) Operation range down to -25 °C in heating with 3 ~ 40 m pipe length range, operation range down to -15 °C in heating with 3 ~ 50 m pipe length range. 4) Check local regulations. * EER and COP calculation is based in accordance to EN14511. ** This product is designed to comply with the European Water Quality Directive 98/83/EC amended by 2015/1787/EU. The lifespan of the product is not guaranteed in the case of the use of groundwater, such as spring water or well water, the use of tap water when salt or other impurities are contained, nor in areas of acidic water quality. Maintenance and warranty costs related to these cases are the customer's responsibility. *** Available Autumn 23.

Accessories	
CZ-RTW1	Additional remote controller for K and L Generations
PAW-TD20C1E5-1	Tank 200 L - Stainless steel
PAW-TD30C1E5-1	Tank 300 L - Stainless steel
PAW-TA20C1E5STD	Tank 200 L - Enamelled
PAW-TA30C1E5STD	Tank 300 L - Enamelled
PAW-3WVVLV-HW	3 way valve for DHW tanks
CZ-NV2	3 way valve kit for inside of hydrokit for K and L Generations

Accessories	
PAW-BTANK50L-2	Buffer tank 50 L
CZ-TAW1B	Aquarea Smart Cloud for remote control and maintenance through wireless or wired LAN
CZ-TAW1-CBL	10 m extension cable for CZ-TAW1B
CZ-NS5P	Additional functions PCB
PAW-A2W-RTWIRED	Room thermostat
PAW-A2W-RTWIRESLESS	Wireless LCD room thermostat



INTERNET CONTROL: Optional.

Aquarea High Performance Bi-bloc J Generation Single phase. Heating and Cooling - SDC · R32

Energy efficiency: COP up to 5,33 / A+++ in heating at 35 °C / "A" water pump with variable speed / Built-in flow meter.

Flexibility: Long piping lengths / Built-in magnetic water filter.

Comfort: Operating range and heating curve down to -20 °C / 60 °C water outlet temperature.

Control: Additional functions with optional PCB (2 zone control, bivalent control, Smart Grid contact and more).

Connectivity: Optional Aquarea Smart and Service Cloud and integration into BMS projects.



011-1W0207
011-1W0208
011-1W0209



3, 5 and
7 kW
models.



		Single phase (power to indoor)				
Kit		KIT-WC03J3E5	KIT-WC05J3E5	KIT-WC07J3E5	KIT-WC09J3E5	
Heating capacity / COP (A +7 °C, W 35 °C)	kW / COP	3,20/5,33	5,00/5,00	7,00/4,76	9,00/4,48	
Heating capacity / COP (A +7 °C, W 55 °C)	kW / COP	3,20/2,81	5,00/2,72	7,00/2,82	8,95/2,78	
Heating capacity / COP (A +2 °C, W 35 °C)	kW / COP	3,20/3,64	4,20/3,18	6,85/3,41	7,00/3,40	
Heating capacity / COP (A +2 °C, W 55 °C)	kW / COP	3,20/2,19	4,10/1,99	6,20/2,21	6,30/2,16	
Heating capacity / COP (A -7 °C, W 35 °C)	kW / COP	3,30/2,80	4,20/2,59	5,60/2,87	6,12/2,78	
Heating capacity / COP (A -7 °C, W 55 °C)	kW / COP	3,20/1,79	3,55/1,71	5,25/1,94	5,90/1,93	
Cooling capacity / EER (A 35 °C, W 7 °C)	kW / EER	3,20/3,52	4,50/3,00	6,70/3,03	8,20/2,72	
Cooling capacity / EER (A 35 °C, W 18 °C)	kW / EER	3,20/4,71	4,80/4,29	6,70/4,72	9,00/4,18	
Heating average climate (W 35 °C / W 55 °C)	Seasonal energy efficiency	SCOP (η _s %)	5,07/3,47(200/136)	5,07/3,47(200/136)	4,90/3,32(193/130)	4,90/3,32(193/130)
	Energy class	A+++ to D	A+++/A++	A+++/A++	A+++/A++	A+++/A++
Heating warm climate (W 35 °C / W 55 °C)	Seasonal energy efficiency	SCOP (η _s %)	6,20/4,20(245/165)	6,20/4,20(245/165)	5,75/4,07(227/160)	5,75/4,07(227/160)
	Energy class	A+++ to D	A+++/A+++	A+++/A+++	A+++/A+++	A+++/A+++
Heating cold climate (W 35 °C / W 55 °C)	Seasonal energy efficiency	SCOP (η _s %)	4,00/2,83(157/110)	4,00/2,83(157/110)	4,18/2,98(164/116)	4,18/2,98(164/116)
	Energy class	A+++ to D	A++/A+	A++/A+	A++/A+	A++/A+
Indoor unit		WH-SDC0305J3E5	WH-SDC0505J3E5	WH-SDC0709J3E5	WH-SDC0709J3E5	
Sound pressure	Heat / Cool	dB(A)	28/28	28/28	30/30	30/31
Dimension	H x W x D	mm	892 x 500 x 340	892 x 500 x 340	892 x 500 x 340	892 x 500 x 340
Net weight		kg	42	42	42	42
Water pipe connector		Inch	R 1½	R 1½	R 1½	R 1½
A class pump	Number of speeds		Variable Speed	Variable Speed	Variable Speed	Variable Speed
	Input power (Min/Max)	W	30/100	33/106	34/114	40/120
Heating water flow (ΔT=5 K, 35 °C)		L/min	9,2	14,3	20,1	25,8
Electric backup heater		kW	3,00	3,00	3,00	3,00
Recommended fuse		A	15/30	15/30	15/30	15/30
Recommended minimum cable size, supply 1 / 2 ¹⁾		mm ²	3 x 1,5/3 x 1,5	3 x 1,5/3 x 1,5	3 x 2,5/3 x 1,5	3 x 2,5/3 x 1,5
Outdoor unit		WH-UD03JE5	WH-UD05JE5	WH-UD07JE5	WH-UD09JE5-1	
Sound power ²⁾	Heat	dB(A)	55	55	59	59
Dimension	H x W x D	mm	622 x 824 x 298	622 x 824 x 298	795 x 875 x 320	795 x 875 x 320
Net weight		kg	37	37	61	61
Refrigerant (R32) / CO ₂ Eq.		kg / T	0,9/0,608	0,9/0,608	1,27/0,857	1,27/0,857
Piping diameter	Liquid / Gas	Inch (mm)	1/4(6,35)/1/2(12,70)	1/4(6,35)/1/2(12,70)	1/4(6,35)/5/8(15,88)	1/4(6,35)/5/8(15,88)
Pipe length range		m	3-25	3-25	3-50	3-50
Elevation difference (in / out)		m	20	20	30	30
Pre-charged pipe length		m	10	10	10	10
Additional gas amount		g/m	20	20	25	25
Operating range - outdoor ambient	Heat	°C	-20 ~ +35	-20 ~ +35	-20 ~ +35	-20 ~ +35
	Cool	°C	+10 ~ +43	+10 ~ +43	+10 ~ +43	+10 ~ +43
Water outlet	Heat / Cool	°C	20 ~ 60/5 ~ 20	20 ~ 60/5 ~ 20	20 ~ 60/5 ~ 20	20 ~ 60/5 ~ 20

1) Check local regulations. 2) Sound power in accordance to 811/2013, 813/2013 and EN12102-1:2017 at +7 °C. * EER and COP calculation is based in accordance to EN14511.

Accessories	
PAW-TD20C1E5-1	Tank 200 L - Stainless steel
PAW-TD30C1E5-1	Tank 300 L - Stainless steel
PAW-TA20C1E5STD	Tank 200 L - Enamelled
PAW-TA30C1E5STD	Tank 300 L - Enamelled
PAW-3WYVLV-HW	3 way valve for DHW tanks
CZ-NV1	3 way valve kit for inside of hydrokit for H and J Generations

Accessories	
PAW-BTANK50L-2	Buffer tank 50 L
CZ-TAW1B	Aquarea Smart Cloud for remote control and maintenance through wireless or wired LAN
CZ-TAW1-CBL	10 m extension cable for CZ-TAW1B
CZ-NS4P	Additional functions PCB
PAW-A2W-RTWIRED	Room thermostat
PAW-A2W-RTWIRELESS	Wireless LCD room thermostat



INTERNET CONTROL: Optional.

Aquarea High Performance Mono-bloc J Generation Single phase. Heating and Cooling - MDC - R32

Energy efficiency: A+++ in heating at 35 °C / "A" water pump with variable speed / Built-in flow meter.

Flexibility: Built-in magnetic water filter / Built-in 6L expansion vessel.

Comfort: Operating range and heating curve down to -20 °C / 60 °C water outlet temperature / Cooling mode down to +10 °C.

Control: Additional functions with optional PCB (2 zone control, bivalent control, Smart Grid contact and more).

Connectivity: Optional Aquarea Smart and Service Cloud and integration into BMS projects.

011-1W0398
011-1W0399
011-1W0400

A++
ErP 55 °C
Scale from
A+++ to D

A+++
ErP 35 °C
Scale from
A+++ to D



Outdoor unit		Single phase			
		WH-MDC05J3E5	WH-MDC07J3E5	WH-MDC09J3E5	
Heating capacity / COP (A +7 °C, W 35 °C)	kW / COP	5,00/5,08	7,00/4,76	9,00/4,48	
Heating capacity / COP (A +7 °C, W 55 °C)	kW / COP	5,00/3,01	7,00/2,82	8,95/2,78	
Heating capacity / COP (A +2 °C, W 35 °C)	kW / COP	5,00/3,57	7,00/3,40	7,45/3,13	
Heating capacity / COP (A +2 °C, W 55 °C)	kW / COP	5,00/2,27	6,30/2,16	7,00/2,12	
Heating capacity / COP (A -7 °C, W 35 °C)	kW / COP	5,00/2,78	6,80/2,81	7,50/2,63	
Heating capacity / COP (A -7 °C, W 55 °C)	kW / COP	5,00/1,85	6,30/1,86	7,00/1,80	
Cooling capacity / EER (A 35 °C, W 7 °C)	kW / EER	5,00/3,31	7,00/3,06	9,00/2,71	
Cooling capacity / EER (A 35 °C, W 18 °C)	kW / EER	5,00/5,05	7,00/4,73	9,00/4,25	
Heating average climate (W 35 °C / W 55 °C)	Seasonal energy efficiency	SCOP (η _s %)	5,12/3,63(202/142)	4,90/3,32(193/130)	4,90/3,32(193/130)
	Energy class		A+++ / A++	A+++ / A++	A+++ / A++
Heating warm climate (W 35 °C / W 55 °C)	Seasonal energy efficiency	SCOP (η _s %)	6,00/4,20(237/165)	5,75/4,07(227/160)	5,75/4,07(227/160)
	Energy class		A+++ / A+++	A+++ / A+++	A+++ / A+++
Heating cold climate (W 35 °C / W 55 °C)	Seasonal energy efficiency	SCOP (η _s %)	4,08/2,95(160/115)	4,18/2,98(164/116)	4,18/2,98(164/116)
	Energy class		A++ / A+	A++ / A+	A++ / A+
Sound power ¹⁾	Heat	dB(A)	59	59	59
Dimension	HxWxD	mm	865x1283x320	865x1283x320	865x1283x320
Net weight		kg	99	104	104
Refrigerant (R32) / CO ₂ Eq. ²⁾		kg / T	1,3/0,878	1,3/0,878	1,3/0,878
Water pipe connector		Inch	R 1½	R 1½	R 1½
Pump	Number of speeds		Variable Speed	Variable Speed	Variable Speed
	Input power (Min/Max)	W	34/96	36/100	39/108
Heating water flow (ΔT=5 K, 35 °C)		L/min	14,3	20,1	25,8
Electric backup heater		kW	3,00	3,00	3,00
Input power	Heat	kW	0,985	1,47	2,01
	Cool	kW	1,51	2,29	3,32
Running and starting current	Heat	A	4,7	7,0	9,3
	Cool	A	7,0	10,5	14,7
Current 1		A	12	17	17
Current 2		A	13	13	13
Recommended fuse		A	30/15	30/15	30/16
Recommended minimum cable size, supply 1 / 2 ³⁾		mm ²	3x1,5/3x1,5	3x2,5/3x1,5	3x2,5/3x1,5
Operating range - outdoor ambient	Heat	°C	-20~35	-20~35	-20~35
	Cool	°C	+10~+43	+10~+43	+10~+43
Water outlet	Heat	°C	20~60	20~60	20~60
	Cool	°C	5~20	5~20	5~20

1) Sound power in accordance to 811/2013, 813/2013 and EN12102-1:2017 at +7 °C. 2) WH-MDC models are hermetically sealed. 3) Check local regulations. * EER and COP calculation is based in accordance to EN14511.

Accessories	
PAW-TD20C1E5-1	Tank 200 L - Stainless steel
PAW-TD30C1E5-1	Tank 300 L - Stainless steel
PAW-TA20C1E5STD	Tank 200 L - Enamelled
PAW-TA30C1E5STD	Tank 300 L - Enamelled
PAW-TD20B8E3-2	Combo Tank 185 L + 80 L - Enamelled
PAW-TD23B6E5	Combo Tank 230 L + 60 L - Stainless Steel
PAW-3WYVLV-HW	3 way valve for DHW tanks
PAW-BTANK50L-2	Buffer tank 50 L

Accessories	
CZ-TAW1B	Aquarea Smart Cloud for remote control and maintenance through wireless or wired LAN
CZ-TAW1-CBL	10 m extension cable for CZ-TAW1B
PAW-A2W-AFVLV	1 anti-freeze valve. It is required to order 2 valves per system
PAW-A2W-RTWIRED	Room thermostat
PAW-A2W-RTWIRELESS	Wireless LCD room thermostat



INTERNET CONTROL: Optional.

Aquarea High Performance Mono-bloc H Generation Single phase. Heating and Cooling - MDC · R410A

Energy efficiency: A+++ in heating at 35 °C / "A" water pump with variable speed / Built-in flow meter.

Flexibility: Optional magnet for the water filter.

Comfort: Operating range and heating curve down to -20 °C / 55 °C water outlet temperature.

Control: Additional functions with optional PCB (2 zone control, bivalent control, Smart Grid contact and more).

Connectivity: Optional Aquarea Smart and Service Cloud and integration into BMS projects.

011-1W0509



Single phase

Outdoor unit			WH-MDC12H6E5	WH-MDC16H6E5
Heating capacity / COP (A +7 °C, W 35 °C)		kW / COP	12,00/4,74	16,00/4,28
Heating capacity / COP (A +7 °C, W 55 °C)		kW / COP	12,00/2,93	14,50/2,72
Heating capacity / COP (A +2 °C, W 35 °C)		kW / COP	11,40/3,44	13,00/3,28
Heating capacity / COP (A +2 °C, W 55 °C)		kW / COP	9,10/2,23	9,80/2,21
Heating capacity / COP (A -7 °C, W 35 °C)		kW / COP	10,00/2,73	11,40/2,57
Heating capacity / COP (A -7 °C, W 55 °C)		kW / COP	8,20/1,95	9,00/1,84
Cooling capacity / EER (A 35 °C, W 7 °C)		kW / EER	10,00/2,81	12,20/2,56
Cooling capacity / EER (A 35 °C, W 18 °C)		kW / EER	9,39/4,65	11,40/4,10
Heating average climate (W 35 °C / W 55 °C)	Seasonal energy efficiency	SCOP (η _s %)	4,82/3,42(190/134)	4,82/3,33(190/130)
	Energy class	A+++ to D	A+++/A++	A+++/A++
Heating warm climate (W 35 °C / W 55 °C)	Seasonal energy efficiency	SCOP (η _s %)	6,20/4,05(245/159)	6,20/4,30(245/169)
	Energy class	A+++ to D	A+++/A+++	A+++/A+++
Heating cold climate (W 35 °C / W 55 °C)	Seasonal energy efficiency	SCOP (η _s %)	4,28/3,10(168/121)	4,28/3,10(168/121)
	Energy class	A+++ to D	A++/A+	A++/A+
Sound power ¹⁾	Heat	dB(A)	65	65
Dimension	HxWxD	mm	1410x1283x320	1410x1283x320
Net weight		kg	140	140
Refrigerant (R410A) / CO ₂ Eq. ²⁾		kg / T	2,10/4,385	2,10/4,385
Water pipe connector		Inch	R 1½	R 1½
Pump	Number of speeds		Variable Speed	Variable Speed
	Input power (Min/Max)	W	34/110	38/120
Heating water flow (ΔT=5 K, 35 °C)		L/min	34,4	45,9
Electric backup heater		kW	6,00	6,00
Input power	Heat	kW	2,53	3,74
	Cool	kW	3,56	4,76
Running and starting current	Heat	A	11,7	16,9
	Cool	A	16,2	21,5
Current 1		A	24,0	26,0
Current 2		A	26,0	26,0
Recommended fuse		A	30/30	30/30
Recommended minimum cable size, supply 1 / 2 ³⁾		mm ²	3x4,0 or 6,0/3x4,0	3x4,0 or 6,0/3x4,0
Operating range - outdoor ambient	Heat	°C	-20 ~ +35	-20 ~ +35
	Cool	°C	+16 ~ +43	+16 ~ +43
Water outlet	Heat	°C	25 ~ 55	25 ~ 55
	Cool	°C	5 ~ 20	5 ~ 20

1) Sound power in accordance to 811/2013, 813/2013 and EN12102-1:2017 at +7 °C. 2) WH-MDC models are hermetically sealed. 3) Check local regulations. * EER and COP calculation is based in accordance to EN14511.

Accessories

PAW-TD20C1E5-1	Tank 200 L - Stainless steel
PAW-TD30C1E5-1	Tank 300 L - Stainless steel
PAW-TA20C1E5STD	Tank 200 L - Enamelled
PAW-TA30C1E5STD	Tank 300 L - Enamelled
PAW-TD20B8E3-2	Combo Tank 185 L + 80 L - Enamelled
PAW-TD23B6E5	Combo Tank 230 L + 60 L - Stainless Steel
PAW-3WYVLV-HW	3 way valve for DHW tanks
PAW-BTANK50L-2	Buffer tank 50 L

Accessories

CZ-TAW1B	Aquarea Smart Cloud for remote control and maintenance through wireless or wired LAN
CZ-TAW1-CBL	10 m extension cable for CZ-TAW1B
PAW-A2W-MGTFILTER	Magnet for the water filter
PAW-A2W-AFVLV	1 anti-freeze valve. It is required to order 2 valves per system
PAW-A2W-RTWIRED	Room thermostat
PAW-A2W-RTWIRELESS	Wireless LCD room thermostat



INTERNET CONTROL: Optional.

NEW Aquarea T-CAP All in One K Generation Single phase Heating and Cooling · R32

Energy efficiency: A+++ in heating at 35 °C and A+ in DHW / "A" water pump with variable speed / Stainless steel DHW tank with U-Vacua™ insulation panel / Built-in flow meter.

Flexibility: 598 x 600 footprint / Built-in magnetic water filter.

Comfort: Constant capacity down to -20 °C / Operating range down to -28 °C / 60 °C hot water even at -10 °C outside temperature.

Control: Optimised user interface and improved features [2 zone control, bivalent control].

Connectivity: Optional Aquarea Smart and Service Cloud and integration into BMS projects.



				Single phase (power to indoor)	
Kit		KIT-AXC09KE5UK		KIT-AXC12KE5UK	
Heating capacity / COP (A +7 °C, W 35 °C)		kW / COP		9,00/5,03	
Heating capacity / COP (A +7 °C, W 55 °C)		kW / COP		9,00/3,07	
Heating capacity / COP (A +2 °C, W 35 °C)		kW / COP		9,00/3,69	
Heating capacity / COP (A +2 °C, W 55 °C)		kW / COP		9,00/2,31	
Heating capacity / COP (A -7 °C, W 35 °C)		kW / COP		9,00/3,00	
Heating capacity / COP (A -7 °C, W 55 °C)		kW / COP		9,00/2,10	
Cooling capacity / EER (A 35 °C, W 7 °C)		kW / EER		8,80/3,11	
Cooling capacity / EER (A 35 °C, W 18 °C)		kW / EER		8,80/4,63	
Heating average climate (W 35 °C / W 55 °C)		Seasonal energy efficiency	SCOP (η _s %)	4,96/3,57(195/140)	
		Energy class ¹⁾		A+++ / A++	
Heating warm climate (W 35 °C / W 55 °C)		Seasonal energy efficiency	SCOP (η _s %)	6,47/4,34(256/171)	
		Energy class ¹⁾		A+++ / A+++	
Heating cold climate (W 35 °C / W 55 °C)		Seasonal energy efficiency	SCOP (η _s %)	4,31/3,26(169/127)	
		Energy class ¹⁾		A++ / A++	
Indoor unit		WH-ADC0912K6E5		WH-ADC0912K6E5	
Sound pressure	Heat / Cool	dB(A)	33/33		33/33
Dimension	HxWxD	mm	1642x599x602		1642x599x602
Net weight		kg	101		101
Water pipe connector		Inch	R 1½		R 1½
A class pump	Number of speeds		Variable Speed		Variable Speed
	Input power (Min/Max)	W	—/145		—/145
Heating water flow (ΔT=5 K, 35 °C)		L/min	25,8		34,4
Water volume		L	185		185
Maximum DHW temperature		°C	65		65
Material inside tank			Stainless steel		Stainless steel
Tapping profile according EN16147			L		L
DHW tank ERP efficiency average / warm / cold ²⁾		A+ to F	A/A+/A		A/A+/A
DHW tank ERP average climate η / COPdHW		η _{wh} % / COPdHW	112/2,80		112/2,80
DHW tank ERP warm climate η / COPdHW		η _{wh} % / COPdHW	132/3,30		132/3,30
DHW tank ERP cold climate η / COPdHW		η _{wh} % / COPdHW	88/2,20		88/2,20
Outdoor unit		WH-UXZ09KE5		WH-UXZ12KE5	
Sound power ³⁾	Heat	dB(A)	51		52
Dimension / Net weight	HxWxD	mm / kg	1340x900x320/88		1340x900x320/88
Refrigerant (R32) / CO ₂ Eq.		kg / T	1,60/1,08		1,60/1,08
Piping diameter	Liquid / Gas	Inch (mm)	1/4 (6,35) / 1/2 (12,70)		1/4 (6,35) / 1/2 (12,70)
Pipe length range / Elevation difference (in / out)		m / m	3-30/20		3-30/20
Pre-charged pipe length / Additional gas amount		m / g/m	10/30		10/30
Operating range - outdoor ambient	Heat	°C	-28 ~ +35		-28 ~ +35
	Cool	°C	+10 ~ +43		+10 ~ +43
Water outlet	Heat / Cool	°C	20 ~ 60/5 ~ 20		20 ~ 60/5 ~ 20
Electrical information		WH-ADC0912K6E5		WH-ADC0912K6E5	
Electric backup heater		kW	6,00		6,00
Recommended fuse		A	30/30		30/30
Recommended minimum cable size, supply 1 / 2 ⁴⁾		mm ²	3x4,0/3x4,0		3x4,0/3x4,0

1) Scale from A+++ to D. 2) Scale from A+ to F. 3) Sound power in accordance to 811/2013, 813/2013 and EN12102-1:2017 at +7 °C. 4) Check local regulations. * EER and COP calculation is based in accordance to EN14511. ** This product is designed to comply with the European Water Quality Directive 98/83/EC amended by 2015/1787/EU. The lifespan of the product is not guaranteed in the case of the use of groundwater, such as spring water or well water, the use of tap water when salt or other impurities are contained, nor in areas of acidic water quality. Maintenance and warranty costs related to these cases are the customer's responsibility. *** Available Autumn 23. **** Tentative data.

Accessories	
CZ-RTW1	Additional remote controller for K and L Generations
CZ-TAW1B	Aquarea Smart Cloud for remote control and maintenance through wireless or wired LAN
CZ-TAW1-CBL	10 m extension cable for CZ-TAW1B

Accessories	
CZ-NS5P	Additional functions PCB
PAW-A2W-RTWIRED	Room thermostat
PAW-A2W-RTWIRELESS	Wireless LCD room thermostat



INTERNET CONTROL: Optional.

NEW Aquarea T-CAP Bi-bloc K Generation Single phase / Three phase. Heating and Cooling - R32

Energy efficiency: A+++ in heating at 35 °C and A+ in DHW / "A" water pump with variable speed / Built-in flow meter.

Flexibility: Built-in magnetic water filter.

Comfort: Constant capacity down to -20 °C / Operating range down to -28 °C / 60 °C hot water even at -10 °C outside temperature.

Control: Optimised user interface and improved features (2 zone control, bivalent control).

Connectivity: Optional Aquarea Smart and Service Cloud and integration into BMS projects.



Tentative data

			Single phase (power to indoor)	Three phase (power to indoor)
Kit 3 kW electric heater			KIT-WXC09K3E5	KIT-WXC09K3E8
Heating capacity / COP (A +7 °C, W 35 °C)	kW / COP		9,00/5,03	9,00/5,03
Heating capacity / COP (A +7 °C, W 55 °C)	kW / COP		9,00/3,07	-/-
Heating capacity / COP (A +2 °C, W 35 °C)	kW / COP		9,00/3,69	9,00/3,69
Heating capacity / COP (A +2 °C, W 55 °C)	kW / COP		9,00/2,31	-/-
Heating capacity / COP (A -7 °C, W 35 °C)	kW / COP		9,00/3,00	-/-
Heating capacity / COP (A -7 °C, W 55 °C)	kW / COP		9,00/2,10	-/-
Cooling capacity / EER (A 35 °C, W 7 °C)	kW / EER		8,80/3,11	8,80/3,11
Cooling capacity / EER (A 35 °C, W 18 °C)	kW / EER		8,80/4,63	-/-
Heating average climate (W 35 °C / W 55 °C)	Seasonal energy efficiency	SCOP (η _s %)	4,96/3,57(195/140)	4,96/3,57(195/140)
	Energy class ¹⁾	A+++ to D	A+++/A++	A+++/A++
Heating warm climate (W 35 °C / W 55 °C)	Seasonal energy efficiency	SCOP (η _s %)	6,47/4,34(256/171)	6,47/4,34(256/171)
	Energy class ¹⁾	A+++ to D	A+++/A+++	A+++/A+++
Heating cold climate (W 35 °C / W 55 °C)	Seasonal energy efficiency	SCOP (η _s %)	4,31/3,26(169/127)	4,31/3,26(169/127)
	Energy class ¹⁾	A+++ to D	A++/A++	A++/A++
Indoor unit 3 kW electric heater			WH-SXC09K3E5	WH-SXC09K3E8
Sound pressure	Heat / Cool	dB(A)	33/33	33/33
Dimension	H x W x D	mm	892 x 500 x 348	892 x 500 x 348
Net weight		kg	—	—
Water pipe connector		Inch	R 1½	R 1½
A class pump	Number of speeds		Variable Speed	Variable Speed
	Input power (Min/Max)	W	—/145	—/145
Heating water flow (ΔT=5 K, 35 °C)		L/min	25,8	25,8
Outdoor unit			WH-UXZ09KE5	WH-UXZ09KE8
Sound power ²⁾	Heat	dB(A)	51	51
Dimension	H x W x D	mm	1340 x 900 x 320	1340 x 900 x 320
Net weight		kg	88	88
Refrigerant (R32) / CO ₂ Eq.		kg / T	1,60/1,08	1,60/1,08
Piping diameter	Liquid / Gas	Inch (mm)	1/4(6,35)/1/2(12,70)	1/4(6,35)/1/2(12,70)
Pipe length range		m	3-30	3-30
Elevation difference (in / out)		m	20	20
Pre-charged pipe length		m	10	10
Additional gas amount		g/m	30	30
Operating range - outdoor ambient	Heat	°C	-28 ~ +35	-28 ~ +35
	Cool	°C	+10 ~ +43	+10 ~ +43
Water outlet	Heat / Cool	°C	20-60/5-20	20-60/5-20

1) Scale from A+++ to D. 2) Sound power in accordance to 811/2013, 813/2013 and EN12102-1:2017 at +7 °C. 3) Check local regulations. * EER and COP calculation is based in accordance to EN14511. ** This product is designed to comply with the European Water Quality Directive 98/83/EC amended by 2015/1787/EU. The lifespan of the product is not guaranteed in the case of the use of groundwater, such as spring water or well water, the use of tap water when salt or other impurities are contained, nor in areas of acidic water quality. Maintenance and warranty costs related to these cases are the customer's responsibility. *** Tentative data.

Accessories

CZ-RTW1	Additional remote controller for K and L Generations
PAW-TD20C1E5-1	Tank 200 L - Stainless steel
PAW-TD30C1E5-1	Tank 300 L - Stainless steel
PAW-TA20C1E5STD	Tank 200 L - Enamelled
PAW-TA30C1E5STD	Tank 300 L - Enamelled
PAW-3WYVYL-HW	3 way valve for DHW tanks
CZ-NV2	3 way valve kit for inside of hydrokit for K and L Generations

Accessories

PAW-BTANK50L-2	Buffer tank 50 L
CZ-TAW1B	Aquarea Smart Cloud for remote control and maintenance through wireless or wired LAN
CZ-TAW1-CBL	10 m extension cable for CZ-TAW1B
CZ-NS5P	Additional functions PCB
PAW-A2W-MGTFILTER	Magnet for the water filter
PAW-A2W-RTWIRED	Room thermostat
PAW-A2W-RTWIREDLESS	Wireless LCD room thermostat



INTERNET CONTROL: Optional.

Aquarea T-CAP Mono-bloc J Generation Single phase / Three phase. Heating and Cooling - MXC · R32

Energy efficiency: A+++ in heating at 35 °C / "A" water pump with variable speed / Built-in flow meter.

Flexibility: Built-in magnetic water filter.

Comfort: Constant capacity and operating range down to -20 °C / 65 °C water outlet temperature.

Control: Additional functions with optional PCB (2 zone control, bivalent control, Smart Grid contact and more).

Connectivity: Optional Aquarea Smart and Service Cloud and integration into BMS projects.

011-1W0463, 011-1W0464, 011-1W0562,
011-1W0563, 011-1W0564, 011-1W0565.
For 9 and 12 kW single and three phase.

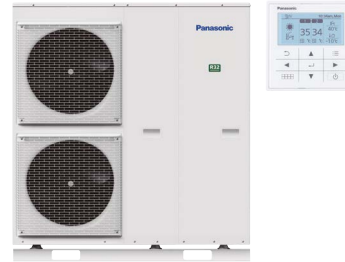

Outdoor unit		Single phase			Three phase		
		WH-MXC09J3E5	WH-MXC12J6E5	WH-MXC09J3E8	WH-MXC12J9E8	WH-MXC16J9E8	
Heating capacity / COP (A +7 °C, W 35 °C)	kW / COP	9,00/5,08	12,00/4,80	9,00/5,08	12,00/4,80	16,00/4,52	
Heating capacity / COP (A +7 °C, W 55 °C)	kW / COP	9,00/3,08	12,00/3,05	9,00/3,08	12,00/3,05	16,00/2,86	
Heating capacity / COP (A +2 °C, W 35 °C)	kW / COP	9,00/3,81	12,00/3,53	9,00/3,81	12,00/3,53	16,00/3,10	
Heating capacity / COP (A +2 °C, W 55 °C)	kW / COP	9,00/2,54	12,00/2,42	9,00/2,54	12,00/2,42	16,00/2,07	
Heating capacity / COP (A -7 °C, W 35 °C)	kW / COP	9,00/3,08	12,00/2,82	9,00/3,08	12,00/2,82	16,00/2,39	
Heating capacity / COP (A -7 °C, W 55 °C)	kW / COP	9,00/2,12	12,00/2,00	9,00/2,12	12,00/2,00	16,00/1,71	
Cooling capacity / EER (A 35 °C, W 7 °C)	kW / EER	9,00/3,18	12,00/2,90	9,00/3,09	12,00/2,84	14,50/2,84	
Cooling capacity / EER (A 35 °C, W 18 °C)	kW / EER	9,00/4,62	12,00/3,95	9,00/4,46	12,00/3,79	16,00/3,75	
Heating average climate (W 35 °C / W 55 °C)	Seasonal energy efficiency	SCOP (η _s %)	4,96/3,57(195/140)	4,96/3,57(195/140)	4,96/3,57(195/140)	4,96/3,57(195/140)	4,46/3,31(176/129)
	Energy class		A+++ / A++	A+++ / A++	A+++ / A++	A+++ / A++	A+++ / A++
Heating warm climate (W 35 °C / W 55 °C)	Seasonal energy efficiency	SCOP (η _s %)	6,47/4,34(256/171)	6,47/4,34(256/171)	6,47/4,34(256/171)	6,47/4,34(256/171)	5,88/4,09(232/160)
	Energy class		A+++ / A+++	A+++ / A+++	A+++ / A+++	A+++ / A+++	A+++ / A+++
Heating cold climate (W 35 °C / W 55 °C)	Seasonal energy efficiency	SCOP (η _s %)	4,31/3,26(169/127)	4,31/3,26(169/127)	4,31/3,26(169/127)	4,31/3,26(169/127)	3,83/3,20(150/125)
	Energy class		A+++ / A++	A++ / A++	A++ / A++	A++ / A++	A++ / A++
Sound power ¹⁾	Heat	dB(A)	65	65	65	65	66
Dimension	HxWxD	mm	1410x1283x320	1410x1283x320	1410x1283x320	1410x1283x320	1410x1283x320
Net weight		kg	140	140	140	140	150
Refrigerant (R32) / CO ₂ Eq. ²⁾		kg / T	1,60/1,080	1,60/1,080	1,60/1,080	1,60/1,080	1,80/1,215
Water pipe connector		Inch	R1¼	R1¼	R1¼	R1¼	R1¼
Pump	Number of speeds		Variable Speed	Variable Speed	Variable Speed	Variable Speed	Variable Speed
	Input power (Min/Max)	W	32/173	34/173	32/173	34/173	38/173
Heating water flow (ΔT=5 K, 35 °C)		L/min	25,8	34,4	25,8	34,4	45,9
Electric backup heater		kW	3,00	6,00	3,00	9,00	9,00
Input power	Heat	kW	1,77	2,50	1,77	2,50	3,54
	Cool	kW	2,83	4,14	2,91	4,23	5,11
Running and starting current	Heat	A	8,3	11,6	2,6	3,7	5,3
	Cool	A	13,1	19,1	4,3	6,3	7,6
Current 1		A	29,0	29,0	14,7	11,8	16,4
Current 2		A	13,0	26,0	13,0	13,0	13,0
Recommended fuse, supply 1 / 2		A	30/30	30/30	20/16	20/20	20/20
Recommended minimum cable size, supply 1 / 2 ³⁾		mm ²	3x4,0 or 6,0/3x4,0	3x4,0 or 6,0/3x4,0	5x1,5/3x1,5	5x1,5/5x1,5	5x2,5/5x1,5
Operating range - outdoor ambient	Heat	°C	-20 ~ +35	-20 ~ +35	-20 ~ +35	-20 ~ +35	-20 ~ +35
	Cool	°C	10 ~ +43	10 ~ +43	10 ~ +43	10 ~ +43	10 ~ +43
Water outlet ⁴⁾	Heat	°C	20 ~ 65	20 ~ 65	20 ~ 65	20 ~ 65	20 ~ 65
	Cool	°C	5 ~ 20	5 ~ 20	5 ~ 20	5 ~ 20	5 ~ 20

1) Sound power in accordance to 811/2013, 813/2013 and EN12102-1:2017 at +7 °C. 2) WH-MXC models are hermetically sealed. 3) Check local regulations. 4) It is possible to set temperature by 65 °C on remote controller. Normally, outlet water temperature is 60 °C or lower. In case of ΔT setting with remote controller is 15 °C and the outdoor ambient temperature is 5 to 20 °C, outlet water temperature 65 °C is possible. * EER and COP calculation is based in accordance to EN14511.

Accessories	
PAW-TD20C1E5-1	Tank 200 L - Stainless steel
PAW-TD30C1E5-1	Tank 300 L - Stainless steel
PAW-TA20C1E5STD	Tank 200 L - Enamelled
PAW-TA30C1E5STD	Tank 300 L - Enamelled
PAW-TD20B8E3-2	Combo Tank 185 L + 80 L - Enamelled
PAW-TD23B6E5	Combo Tank 230 L + 60 L - Stainless Steel
PAW-3WYVLV-HW	3 way valve for DHW tanks
PAW-BTANK50L-2	Buffer tank 50 L

Accessories	
CZ-TAW1B	Aquarea Smart Cloud for remote control and maintenance through wireless or wired LAN
CZ-TAW1-CBL	10 m extension cable for CZ-TAW1B
PAW-A2W-AFVLV	1 anti-freeze valve. It is required to order 2 valves per system
PAW-A2W-RTWIRED	Room thermostat
PAW-A2W-RTWIRELESS	Wireless LCD room thermostat



INTERNET CONTROL: Optional.

Fan coils highlighted features

MORE FAN COIL OPTIONS IN CHILLERS SECTION

Available in a wide range of designs, the fan coils are perfectly adapted to fit within almost any location.



1 Innovation for an optimum comfort

Range of fan coils for heating and cooling with capacities from 0,2 to 9,6 kW in cooling and from 0,2 to 13,6 kW in heating. Bring full year comfort with hydronic systems.

2 Energy efficient and low noise fan

Dynamically balanced and specially designed fans, reinforced acoustic insulation and optimised fan speed staging for lower noise levels. Improved efficiency with optional EC fan motor.

3 Quality and efficient coil

Constructed from staggered copper tubes, mechanically expanded into aluminium fins, providing maximum heat transfer efficiency, durability and hygiene.

4 Flexible installation

Various types of unit to fit your needs with flexible installation options. A choice of service side for hydraulic connections, piping configuration and horizontal or vertical installation for ducted units.

Offering a great range of capacities and performance, available in a wide range of designs, the fan coils are perfectly adapted to fit within almost any location. Whether the requirements are for cooling only, or for both heating and cooling, there is a fan coil to suit. With a variety of piping and fan configuration, the range is capable of meeting the most stringent of requirements. Line up available in AC and EC fans, it is possible to achieve both powerful performance, but with sustainability in mind.

Controllers with sophisticated designs, provide a user friendly interface while enabling an easy and low cost integration to building management systems.

Optional wired remote controller for AC fan, 2-pipe and 4-pipe application.



PAW-FC-RC1

Optional wired remote controller for AC fan 2-pipe application.



PAW-FC-903AC



PAW-FC-907AC

Optional wired remote controller for EC fan, 2-pipe and 4-pipe application.



PAW-FC-903EC



PAW-FC-907EC

Smart fan coils



Built-in advanced thermostat.



			PAW-AAIR-200-2	PAW-AAIR-700-2	PAW-AAIR-900-2	NEW PAW-AAIR-1100-2
Total cooling capacity	Lo/Med/Hi	kW	0,3/0,5/0,6	0,6/0,9/1,5	0,8/1,6/2,1	0,9/1,8/2,5
Sensible capacity	Lo/Med/Hi	kW	0,2/0,4/0,6	0,5/0,9/1,3	0,7/1,3/1,9	0,9/1,6/2,3
Water flow	Lo/Med/Hi	kg/h	51,1/89,4/106,3	96,0/155,2/251,1	140,8/267,2/365,7	158,1/300,3/423,6
Water pressure drop	Lo/Med/Hi	kPa	3,3/5,7/6,1	1,1/2,1/4,2	1,5/5,8/10,3	1,3/5,0/10,6
Inlet water temperature		°C	10	10	10	10
Outlet water temperature		°C	15	15	15	15
Inlet air temperature		°C	27	27	27	27
Outlet air temperature	Lo/Med/Hi	°C	12,8/13,2/14,9	14,6/14,8/14,0	15,8/14,6/14,4	18,1/15,2/14,7
Relative humidity of inlet air		%	47	47	47	47
Total heating capacity	Lo/Med/Hi	kW	0,2/0,4/0,5	0,4/0,8/1,2	0,6/1,2/1,6	0,8/1,4/2,1
Water flow	Lo/Med/Hi	kg/h	38,4/70,5/92,8	72,7/139,2/201,6	114,0/204,2/284,5	138,3/243,2/356,7
Water pressure drop	Lo/Med/Hi	kPa	1,0/2,3/3,0	0,5/1,5/3,1	1,0/3,3/6,6	1,1/3,1/7,3
Inlet water temperature		°C	35	35	35	35
Outlet water temperature		°C	30	30	30	30
Inlet air temperature		°C	19	19	19	19
Outlet air temperature	Lo/Med/Hi	°C	33,5/33,3/30,9	30,1/31,4/31,8	30,1/31,1/31,2	26,6/29,5/30,5
Air flow	Lo/Med/Hi	m ³ /min	0,9/1,9/2,7	2,6/4,2/5,3	4,1/6,1/7,7	6,2/7,6/9,6
Maximum input power	Lo/Med/Hi	W	7,0/9,0/13,0	14,0/18,0/22,0	16,0/20,0/24,0	18,0/22,0/26,5
Sound pressure	Lo/Med/Hi	dB(A)	24/33/39	25/34/40	25/34/42	26/35/43
Dimension (HxWxD)		mm	735x579x129	935x579x129	1135x579x129	1335x579x129
Net weight		kg	17	20	23	26
3 Ways valve included			Yes	Yes	Yes	Yes
Touch screen thermostat			Yes	Yes	Yes	Yes

* Smart fan coils is produced by Innova.

Accessories

PAW-AAIR-LEGS-1 Kits of 2 legs to protect the water pipings

Accessories

PAW-AAIR-RHCABLE Motor connection cable for units with hydraulic connections on the right

Stylish floor-standing fan coils with advanced controller

The slimline of Smart fan coils delivers high efficiency climate control.

With a depth of just under 130 mm they are at the cutting edge of the market. Blending easily into the home, Smart fan coil's elegant design and product refinements are clear to see in every detail.

Exceptional ventilation efficiency means the motor uses considerably less energy (low wattage). The fan speed is continuously modulated by the temperature controller with proportional integral logic, with undoubted advantages for regulating the temperature and humidity in summer mode.

With standard cast radiators.

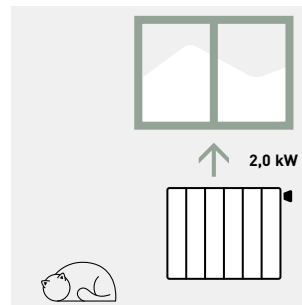

Water at 65 °C needed.

With Smart fan coil.

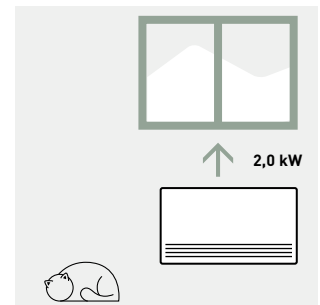

Water at 35 °C needed.

Technical focus

- 4 operation modes (auto, silent, night-time and maximum ventilation speed)
- Exclusive design
- Extremely compact (only 129 mm deep)
- Cooling and dehumidification functions possible (drain is needed)
- 3-way valve included (no overflow valve needed on the installation if more than 3 units installed)
- Touch screen thermostat

All temperature curves and capacity are available on www.panasonicproclub.com

PRO Club



Fan coils - ducted (AC)



Optional controller.
Advanced wired remote
controller.
PAW-FC-RC1



Optional controller.
Wired remote controller
with touch control.
PAW-FC-907AC



Optional controller.
Wired remote controller.
PAW-FC-903AC



Left connection (PAW-)		FC2A-D010L	FC2A-D020L	FC2A-D030L	FC2A-D040L	FC2A-D050L	FC2A-D060L	FC2A-D070L	FC2A-D080L	
Right connection (PAW-)		FC2A-D010R	FC2A-D020R	FC2A-D030R	FC2A-D040R	FC2A-D050R	FC2A-D060R	FC2A-D070R	FC2A-D080R	
Total cooling capacity ¹⁾	Lo/Med/Hi	kW	0,7/1,0/1,5	0,7/1,2/1,7	1,0/2,0/2,5	1,2/2,4/3,2	1,7/3,2/4,6	2,7/4,6/5,8	3,4/6,1/7,3	4,6/6,1/8,1
Sensible capacity ¹⁾	Lo/Med/Hi	kW	0,5/0,8/1,1	0,6/0,9/1,3	0,8/1,5/1,9	0,9/1,8/2,3	1,2/2,2/3,3	1,9/3,3/4,5	2,4/4,3/5,1	3,4/4,6/6,3
Water flow	Lo/Med/Hi	l/h	124/172/250	127/213/289	172/341/430	206/413/547	296/544/798	466/784/1003	587/1058/1252	798/1048/1400
Water pressure drop	Lo/Med/Hi	kPa	10,7/19,5/39,2	1,9/3,9/6,3	6,3/19,3/28,8	5,4/17,1/28,0	7,5/22,8/46,9	13,9/37,4/60,2	4,8/15,4/21,5	11,9/19,3/32,5
Heating capacity ²⁾	Lo/Med/Hi	kW	0,9/1,4/2,0	0,9/1,5/2,2	1,3/2,4/3,1	1,4/2,9/4,0	2,1/4,1/5,7	3,1/5,3/7,1	4,3/7,9/9,3	5,9/8,1/11,6
Sound levels										
Global sound power	Lo/Med/Hi	dB(A)	33/40/49	31/43/50	30/45/52	30/44/51	34/46/56	38/51/58	43/56/61	50/55/64
Global sound pressure ³⁾	Lo/Med/Hi	dB(A)	24/31/40	22/34/41	21/36/43	21/35/42	25/37/47	29/42/49	34/47/52	41/46/55
Fan										
Number			1	1	1	2	2	2	2	3
Air flow	Lo/Med/Hi	m ³ /h	111/190/283	105/179/265	138/274/390	173/357/499	253/486/716	350/640/933	480/893/1064	660/936/1397
External pressure	Max	Pa	55	55	65	85	85	115	125	70
Filter			G2	G2	G2	G2	G2	G2	G2	G2
Electrical data										
Power supply	Voltage	V	230	230	230	230	230	230	230	230
	Phase		Single phase	Single phase	Single phase	Single phase	Single phase	Single phase	Single phase	Single phase
	Frequency	Hz	50/60	50/60	50/60	50/60	50/60	50/60	50/60	50/60
Consumption	Lo/Med/Hi	W	13/24/36	10/18/29	16/37/45	15/37/56	28/55/72	37/75/105	53/100/147	90/112/188
Water connections										
Type			Female gas threaded	Female gas threaded	Female gas threaded	Female gas threaded	Female gas threaded	Female gas threaded	Female gas threaded	Female gas threaded
Water connections	Inch		1/2	1/2	1/2	1/2	1/2	1/2	3/4	3/4
Dimension and weight										
Dimension	H x W x D	mm	220 x 570 x 430	220 x 570 x 430	220 x 730 x 430	220 x 938 x 430	220 x 1122 x 430	220 x 1307 x 430	220 x 1121 x 530	220 x 1316 x 530
Weight		kg	13	13	15	20	22	26	27	38

1) According to Eurovent standard. Air: 27 °C DB / 19 °C WB. Water in / out: 7 °C / 12 °C. 2) Air: 20 °C. Water in / out: 50 °C / 45 °C. 3) The sound pressure levels are based on (NR) characteristics of a room having volume of 100 m³ with reverberation of 0,5 seconds.

Values indicated are for 0 Pa external static pressure, for additional pressure characteristics, please refer the selection software. * Fan coil units are produced by Systemair.

Accessories

PAW-FC-RC1	Advanced wired remote controller
PAW-FC-907AC	Wired remote controller with touch control
PAW-FC-903AC	Wired remote controller
PAW-FC-2WY-11/55-1	2 way valve + drain pan for models 010-060

Accessories

PAW-FC-2WY-65/90-1	2 way valve + drain pan for models 070-080
PAW-FC-3WY-11/55-1	3 way valve + drain pan for models 010-060
PAW-FC-3WY-65/90-1	3 way valve + drain pan for models 070-080

Technical focus

- Cooling capacity: 0,7 to 8,1 kW
- Heating capacity: 0,7 to 10,3 kW
- 5-speed AC fan motor(s)

Main features and accessories

- Left or right hand arrangements
- Ease of installation
- Very low acoustic levels
- 2 way or 3 way ON / OFF valves
- Auxiliary drain pan
- Air intake with removable grid
- G2 filter

Operating limits

Entering water temperature	From 5 to 90 °C
Indoor air temperature	From 5 to 32 °C



ERP 2018: compliant following COMMISSION REGULATION (EU) No2016/2281.

Fan coils - ducted (EC)



Optional controller.
Wired remote controller
with touch control.
PAW-FC-907EC



Optional controller.
Wired remote controller.
PAW-FC-903EC

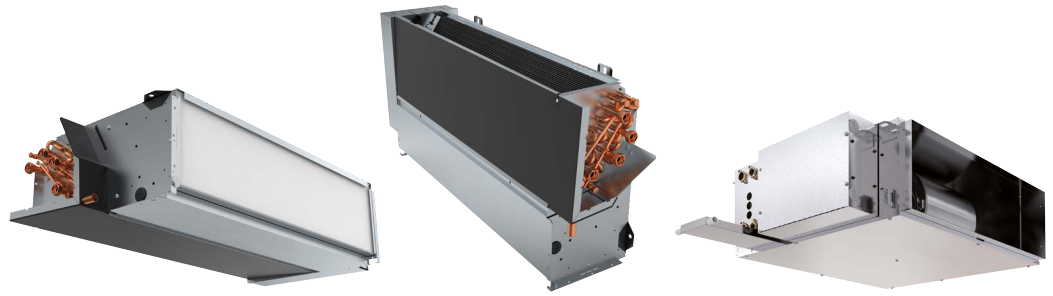

Left connection (PAW-)		FC2E-D010L	FC2E-D020L	FC2E-D030L	FC2E-D040L	FC2E-D050L	FC2E-D060L	FC2E-D070L	FC2E-D080L	FC2E-F040L
Right connection (PAW-)		FC2E-D010R	FC2E-D020R	FC2E-D030R	FC2E-D040R	FC2E-D050R	FC2E-D060R	FC2E-D070R	FC2E-D080R	FC2E-F040R
Total cooling capacity ¹⁾	Lo/Med/Hi kW	0,6/1,2/2,1	0,6/1,4/2,4	0,9/2,1/3,1	1,3/2,9/4,2	1,3/4,0/5,0	2,0/4,5/5,2	2,7/5,9/6,9	5,1/6,5/8,8	3,6/6,6/9,2
Sensible capacity ¹⁾	Lo/Med/Hi kW	0,5/1,1/1,9	0,5/1,1/1,9	0,6/1,6/2,4	1,0/2,1/3,0	1,1/3,0/3,7	1,4/3,5/4,0	2,0/4,3/5,2	3,7/4,8/6,6	2,9/6,1/9,1
Water flow	Lo/Med/Hi l/h	107/210/356	110/237/406	148/354/532	230/506/722	231/685/743	341/767/800	463/1008/1098	879/1111/1254	627/1142/1575
Water pressure drop	Lo/Med/Hi kPa	8,2/28,2/76,9	1,5/4,6/11,0	5,0/20,5/42,1	6,4/24,4/46,3	4,9/35,1/41,0	7,8/35,8/38,8	3,0/14,0/16,6	14,1/21,4/26,6	10,6/51,2/93,8
Heating capacity ²⁾	Lo/Med/Hi kW	0,8/1,6/2,9	0,9/1,9/3,3	1,0/2,2/3,4	1,4/3,0/5,3	1,7/5,2/5,5	2,3/5,9/6,1	3,8/7,3/8,2	6,2/8,0/9,3	4,4/8,3/11,8
Sound levels										
Global sound power	Lo/Med/Hi dB(A)	34/47/60	34/47/60	31/50/59	29/44/52	30/51/57	32/54/58	40/54/59	51/56/64	42/58/68 ³⁾
Global sound pressure ⁴⁾	Lo/Med/Hi dB(A)	25/38/51	25/38/51	22/41/50	20/35/43	21/42/48	23/45/49	31/45/50	42/47/55	23/39/52
Fan										
Number		1	1	1	2	2	2	2	3	1
Air flow	Lo/Med/Hi m ³ /h	108/228/417	98/234/413	145/380/585	170/412/678	203/645/816	245/737/912	350/850/1050	685/927/1398	592/1284/1935
External pressure	Max Pa	75	75	75	105	70	105	115	70	190
Filter		G2	G2	G2	G2	G2	G2	G2	G2	G2
Electrical data										
Power supply	Voltage V	230	230	230	230	230	230	230	230	230
	Phase	Single phase	Single phase	Single phase	Single phase	Single phase	Single phase	Single phase	Single phase	Single phase
	Frequency Hz	50/60	50/60	50/60	50/60	50/60	50/60	50/60	50/60	50/60
Consumption	Lo/Med/Hi W	5/11/41	5/13/41	4/16/42	2/13/43	4/24/46	2/30/54	11/44/77	23/42/108	11/62/197
Water connections										
Type		Female gas threaded	Female gas threaded	Female gas threaded	Female gas threaded	Female gas threaded	Female gas threaded	Female gas threaded	Female gas threaded	Female gas threaded
Water connections	Inch	1/2	1/2	1/2	1/2	1/2	1/2	3/4	3/4	3/4
Dimension and weight										
Dimension	H x W x D mm	220x570x430	220x570x430	220x730x430	220x938x430	220x1122x430	220x1307x430	220x1121x530	220x1316x530	223x1233x653
Weight	kg	13	13	15	20	22	26	27	38	19

1) According to Eurovent standard. Air: 27 °C DB / 19 °C WB. Water in / out: 7 °C / 12 °C. 2) Air: 20 °C. Water in / out: 50 °C / 45 °C. 3) The sound power levels indicated are from return and radiated measurements. 4) The sound pressure levels are based on (NR) characteristics of a room having volume of 100 m³ with reverberation of 0,5 seconds. Values indicated are for 0 Pa external static pressure, for additional pressure characteristics, please refer the selection software. * Fan coil units are produced by Systemair.

Accessories	
PAW-FC-907EC	Wired remote controller with touch control
PAW-FC-903EC	Wired remote controller
PAW-FC-2WY-11/55-1	2 way valve + drain pan for models 010-060
PAW-FC-2WY-65/90-1	2 way valve + drain pan for models 070-080

Accessories	
PAW-FC-2WY-F040	2 way valve + drain pan for model F040
PAW-FC-3WY-11/55-1	3 way valve + drain pan for models 010-060
PAW-FC-3WY-65/90-1	3 way valve + drain pan for models 070-080
PAW-FC-3WY-F040	3 way valve + drain pan for model F040

Technical focus

- Cooling capacity: 0,5 to 9,6 kW
- Heating capacity: 0,6 to 13,6 kW
- Low energy consumption EC fan(s)

Main features and accessories

- Left or right hand arrangements
- Can be installed both horizontally and vertically*
- Ease of installation
- Very low acoustic levels
- 2 way or 3 way ON / OFF valves
- Auxiliary drain pan
- Air intake with removable grid
- G2 filter

Operating limits	
Entering water temperature	From 5 to 90 °C
Indoor air temperature	From 5 to 32 °C

* PAW-FC2E-F040 may only be installed horizontally.



Fan coils - wall-mounted (AC)



Optional controller.
Advanced wired remote
controller.
PAW-FC-RC1



Optional controller.
Wired remote controller
with touch control.
PAW-FC-907AC



Optional controller.
Wired remote controller.
PAW-FC-903AC



Infrared remote supplied
with IR versions.
IR Controller



2-pipe			PAW-FC2A-K007	PAW-FC2A-K009	PAW-FC2A-K018	PAW-FC2A-K022
			PAW-FC2A-K007IR	PAW-FC2A-K009IR	PAW-FC2A-K018IR	PAW-FC2A-K022IR
Total cooling capacity ¹⁾	Lo/Med/Hi	kW	1,0/1,3/1,7	1,6/1,7/2,4	2,8/3,0/3,5	2,9/3,1/3,9
Sensible capacity ¹⁾	Lo/Med/Hi	kW	0,7/1,0/1,2	1,2/1,3/1,9	2,1/2,3/2,7	2,3/2,5/3,1
Water flow	Lo/Med/Hi	l/h	172/231/287	270/291/418	483/508/609	502/535/669
Water pressure drop	Lo/Med/Hi	kPa	18,6/24,9/30,9	18,5/27,0/40,0	34,6/41,3/55,6	37,2/33,7/45,2
Heating capacity ²⁾	Lo/Med/Hi	kW	1,4/1,7/2,0	1,7/2,0/2,7	2,9/3,2/4,0	3,1/3,7/4,4
Sound levels						
Sound power	Lo/Med/Hi	dB(A)	45/49/51	47/52/57	49/53/59	56/59/63
Sound pressure ³⁾	Lo/Med/Hi	dB(A)	32/36/38	34/39/44	40/43/46	43/46/50
Fan						
Number			1	1	1	1
Air flow	Lo/Med/Hi	m ³ /h	282/321/360	367/413/551	532/592/680	617/709/850
Filter			G1	G1	G1	G1
Electrical data						
Power supply	Voltage	V	230	230	230	230
	Phase		Single phase	Single phase	Single phase	Single phase
	Frequency	Hz	50	50	50	50
Fuse rating		A	3	3	3	3
Consumption	Lo/Med/Hi	W	39/42/62	30/47/59	44/50/55	50/55/70
Water connections						
Type			Female gas threaded	Female gas threaded	Female gas threaded	Female gas threaded
Water connections		Inch	1/2	1/2	1/2	1/2
Dimension and weight						
Dimension	H x W x D	mm	275 x 180 x 845	275 x 180 x 845	298 x 200 x 940	298 x 200 x 940
Weight		kg	11	11	13	13

1) According to Eurovent standard. Air: 27 °C DB / 19 °C WB. Water in / out: 7 °C / 12 °C. 2) According to Eurovent standard. Air: 20 °C. Water in / out: 45 °C / 40 °C. 3) Sound pressure considering a local of 100 m³ a reverberation time of 0,5 seconds and a distance of 1 m.

Accessories

PAW-FC-RC1	Advanced wired remote controller
PAW-FC-907AC	Wired remote controller with touch control
PAW-FC-903AC	Wired remote controller

Accessories

PAW-FC2-2WY-K007	2 way valve
PAW-FC2-3WY-K007	3 way valve

Technical focus

- 4 sizes
- Cooling capacity: 1,0 to 3,9 kW
- Heating capacity: 1,4 to 4,1 kW
- Version: 2-pipes, AC fan

Main features and accessories

- 2 way or 3 way valve ON / OFF
- 3-speed AC fan motor
- Silent unit for optimum customer comfort
- Aesthetic design suitable for residential and hotel applications
- Compatible with IR controller (supplied with IR versions)
- Coil with hydrophilic fins to improve the condensate flow

* The electric movement of the flaps is available for the IR version.

Operating limits

Entering water temperature	From 5 to 60 °C
Indoor air temperature	From 6 to 40 °C



Wired controllers for AC and EC fan coils

Advanced wired remote controller (AC)

PAW-FC-RC1

This advanced controller provides a higher level of comfort in heating. The sensor can be used as a water flow sensor, stopping the fan when the water temperature is low, avoiding cold drafts in winter.

Features:

- For 2-pipe and 4-pipe, AC fan
- Change Over function (cold draft prevention)
- Room thermostat
- 3 outputs, 230 V relays for fan control
- 2 outputs, 230 V relays for heating / cooling control
- Connection to BMS - Modbus RTU slave
- 1 DI for presence detection (key card switch)
- 1 AI for sensor



Wired remote controller (AC/EC)

Stylish and sophisticated design with backlit LCD display, is suitable for installation within a wide variety of locations such as office, hotel and residential applications. By connecting the controller to the range of AC/EC fan coils, the user can take advantage of the improved performance, higher levels of efficiency and thus improved energy savings.

PAW-FC-907AC

Features:

- For 2-pipe, AC fan
- Back lit LCD screen with touch control
- 3 speed control relay, for fan
- Economizer

PAW-FC-907EC

Features:

- For 2-pipe and 4-pipe, EC fan
- Back lit LCD screen with touch control
- Adjustable range EC fan control
- Economizer
- Connection to BMS via Modbus
- 1 DI for presence detection (key card switch)



Wired remote controller (AC/EC)

Feature rich and perfectly adapted to control AC/EC fan coils, the PAW-FC-903AC/EC is the addition for any fan coil. With intuitive user interface provided by the push button control and large LCD display, it will fit seamlessly with almost any location.

PAW-FC-903AC

Features:

- For 2-pipe, AC fan
- Back lit LCD screen
- 3 speed control relay, for fan
- Economizer

PAW-FC-903EC

Features:

- For 2-pipe and 4-pipe, EC fan
- Back lit LCD screen
- Adjustable range EC fan control
- Economizer
- Connection to BMS via Modbus
- 1 DI for presence detection (key card switch)



Sanitary tanks

Combo tanks.

The best option to combine with Mono-bloc units. DHW tank with buffer tank. Designed for retrofit applications, the DHW tank with a buffer tank is particularly suitable for fast integration on an existing installation. Easy to install, nice looking, high efficiency for DHW production and for heating.

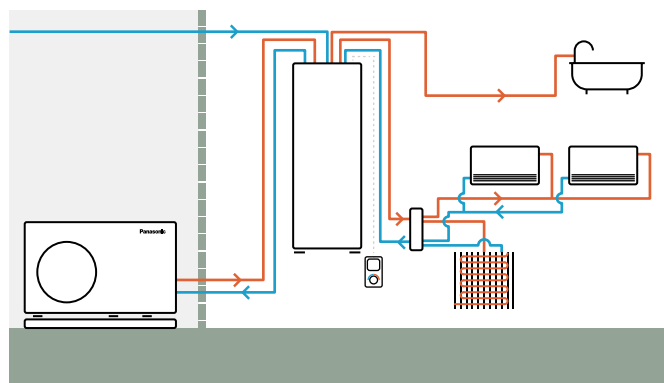

Reference	PAW-TD20B8E3-2		PAW-TD23B6E5	
Material	Enamelled		Stainless steel	
Dimension HxWxD	mm 1770 x 640 x 690		1750 x 600 x 646	
Weight (empty)	kg 150		111	
Water volume	L 185 + 80		230 + 60	
Power supply	V, Phase, Hz 230, 1, 50		230, 1, 50	
	Hot water tank	Buffer tank	Hot water tank	Buffer tank
Water volume	L 185	80	230	60
Max working pressure	MPa (bar) 0,8 (8)	0,6 (6)	1,0 (10)	0,3 (3,0)
Pressure test	MPa (bar) 1,2 (12)	0,9 (9)	1,5 (15)	0,39 (3,9)
Max working temp	°C 90	90	80	80
Connections	mm Ø22	Ø22	Ø22	Ø22, copper
Material	S 275 JR vitrified		EN 14521	EN 14521
Insulation	Material, t=mm PUR, 50	PUR 40	PUR, 50	PUR, 50
Heating coil surface	m² 2,1	—	1,8	—
Electrical heater	W 3000	—	2800	—
Energy loss at 65 °C ¹⁾	kWh/24h 1,3	—	1,25	—
Energy efficiency class (from A+ to F) ²⁾	B	B	B	A
Standing loss	W 53	46	52	29

1) Tested pursuant to EN 12897:2006. 2) EU Regulation 812/2013. * Enamelled Combo tank is produced by Lapesa. Stainless steel Combo tank is produced by OSO.



Buffer tanks.

Reference	PAW-BTANK50L-2	PAW-BTANK100L	NEW PAW-BTANKG200L	NEW PAW-BTANKG260L
Water volume	L 48	100	194	252
Energy losses	W 35	55	60	83
Energy efficiency class (from A+ to F)	B	C	B	C
Material	Stainless Steel	Stainless Steel	Carbon Steel	Carbon Steel
Dimension (Height / Diameter)	mm 636 / 430	1175 / 430	983 / 620	1239 / 620
Net weight	kg 17	28	41	46

* Automatic air vent and drain cock are included. Built-in pocket sensor (sensor not included). ** 50 and 100 L Buffer Tanks are produced by OSO. 200 and 260 L Buffer Tanks are produced by Lapesa.



DUO Pre-plumbed tank

Tank	Material	Water volume L	Energy efficiency class A+ to F	Dimension Height / Diameter mm	Weight kg
1ph PAW-TD20B7PP-UK	Stainless steel	185	C	1992 / 550	51
PAW-TD23B6E5PP-UK	Stainless steel	225	A	1755 / 595	TBC
PAW-TD30B7PP-UK	Stainless steel	285	C	2030 / 630	64

1) Tested pursuant to EN 12897:2006. 2) EU Regulation 812/2013.



Stainless steel tanks.

Reference		PAW-TD20C1E5-1	PAW-TD30C1E5-1	PAW-TD30C1E5HI-1
Water volume	L	192	284	280
Maximum water temperature	°C	75	75	75
Dimension (Height / Diameter)	mm	1270 / 595	1750 / 595	1750 / 595
Weight / filled with water	kg	50 / —	61 / —	65 / —
Electric heater	kW	1,5	1,5	1,5
Power supply	V	230	230	230
Material inside tank		Stainless steel	Stainless steel	Stainless steel
Exchange surface	m ²	1,8	1,8	2,35
Energy loss at 65 °C ¹⁾	kWh/24h	1,01	1,18	1,18
3 way valve accessory PAW-3WYVLV-HW, CZ-NV1 or CZ-NV2		Optional	Optional	Optional
20 m temperature sensor cable included		Yes	Yes	Yes
Energy losses	W	42	49	49
Energy efficiency class (from A+ to F)		A	A	A
Warranty		2 Years	2 Years	2 Years
Maintenance required		No	No	No

1) Insulated tested under EN12897. * Stainless steel tanks are produced by OSO.

Accessories for sanitary tanks

PAW-3WYVLV-HW	3 way valve for DHW tanks
CZ-NV1	3 way valve kit for inside of hydrokit for H and J Generations

Accessories for sanitary tanks

CZ-NV2	3 way valve kit for inside of hydrokit for K and L Generations
PAW-EANODE2	Impressed current anode for 200 L Stainless Steel tanks
PAW-EANODE3	Impressed current anode for 300 L Stainless Steel tanks

Heat recovery ventilation unit

The heat recovery ventilation unit is design not only to provide a good indoor air quality, but it is also designed to recover heat that would otherwise be lost throughout ventilation. These heat recovery ventilation systems are used to assist in the retention of heat.

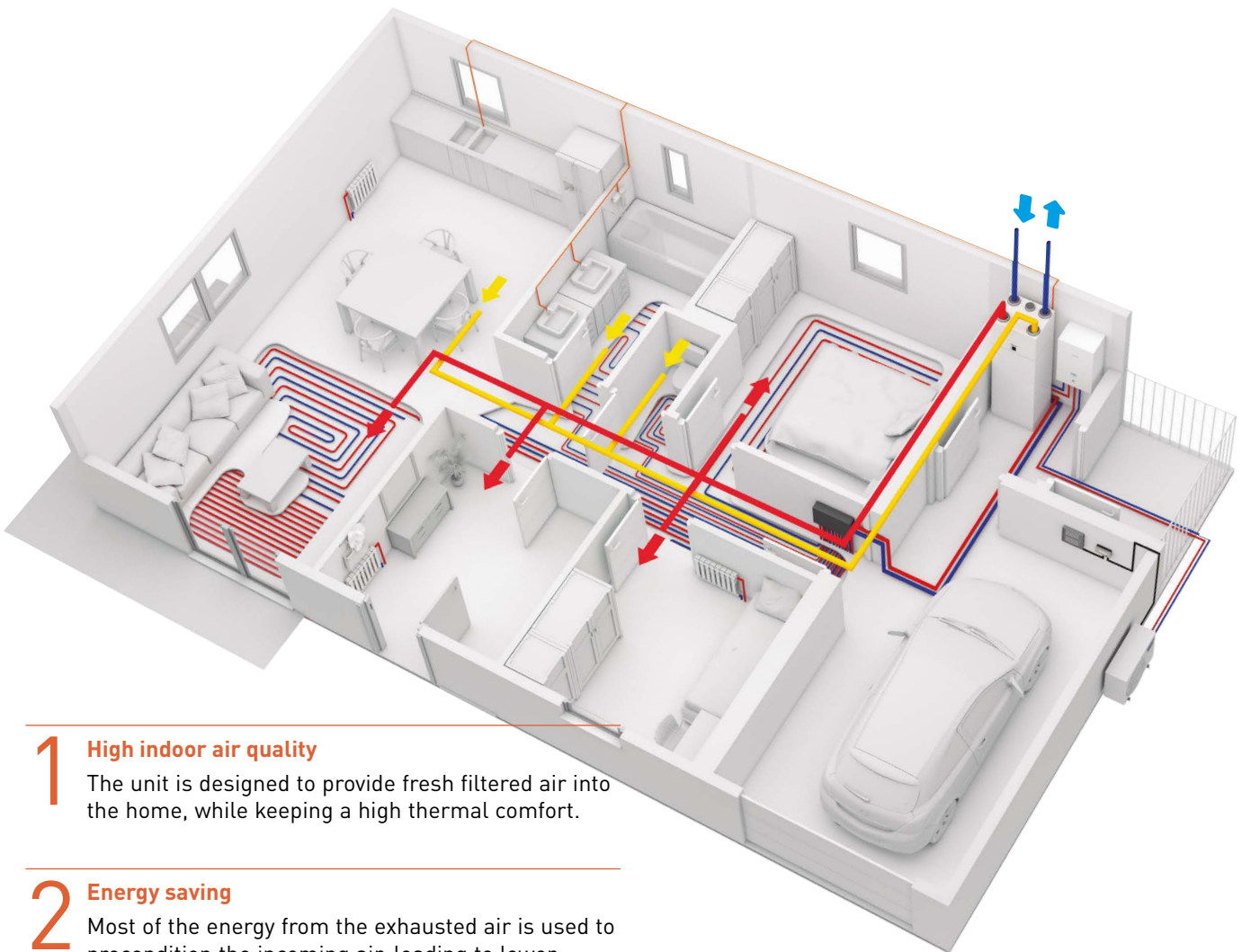

1 High indoor air quality
The unit is designed to provide fresh filtered air into the home, while keeping a high thermal comfort.

2 Energy saving
Most of the energy from the exhausted air is used to precondition the incoming air, leading to lower heating requirements in the building.

3 Space saving
The compact ventilation unit can be installed over the DHW square tank or the Aquarea All in One Compact indoor unit for an space-saving solution.

4 Better user interface
The Residential ventilation unit and the Aquarea Heat Pump can be controlled with one single user-friendly controller.

AQUAREA

Combine the Residential ventilation unit with Panasonic Aquarea for an space saving and highly efficient solution for heating, cooling, ventilation and DHW.



Heat Recovery Ventilation + Aquarea All in One Compact



Heat Recovery Ventilation + DHW Square Tank + Aquarea Mono-bloc



Heat Recovery Ventilation + DHW Square Tank + Aquarea Bi-bloc

* The unit can be mounted on a PAW-TA20C1E5C, on a WH-ADC0309J3E5C or installed on the wall (PAW-VEN-WBRK is needed).



Heat recovery ventilation unit		PAW-A2W-VENTA-R	PAW-A2W-VENTA-L
Nominal air flow rate	m ³ /h	204 @ 50 Pa	
Maximum air flow rate	m ³ /h	292 @ 100 Pa	
SPF		1,24 @ 204 m ³ /h	
Heat exchanger rotor drive type		Variable speed	
Exchanger type		Rotating	
Heat recovery efficiency		84%	
Power supply	V / Hz	230 / 50 / Single phase	
Power consumption	W	176	
Energy class, basic unit		A	
Energy class, unit with local control on demand		A	
Noise level	dB(A)	40	
Dimension (HxWxD)	mm	450x598x500	
Weight	kg	46	
Mounting position		Vertical	
Supply side		Right	Left
Duct connections	mm	DN125	
Filter class, supply air		F7/ePM1 60%	
Filter class, extract air		M5/ePM10 50%	
Minimum outdoor temperature	°C	-20	

* Heat recovery efficiency according to EN 13141-7. ** Heat recovery ventilation unit is produced by Systemair.

Accessories	
PAW-VEN-FLTKIT	Supply and extract filters kit
PAW-VEN-ACCPCB	Optional PCB for additional functions
PAW-VEN-DPL	HRV touch control panel. White frame (cable must be ordered separately)
PAW-VEN-CBLEXT12	Cable with plug for electrical connection between unit and control panel, type CE and CD (12 m)
PAW-VEN-DIVPLG	Twin plugs for installation of several control panels type CD or CE for one unit

Accessories	
PAW-VEN-DPLBOX	HRV touch control panel wall-mounted kit
PAW-VEN-S-CO2RH-W	CO ₂ RH wall-mounted sensor
PAW-VEN-S-CO2-W	CO ₂ wall-mounted sensor
PAW-VEN-S-CO2-D	CO ₂ duct sensor
PAW-VEN-WBRK	Wall bracket kit for stand-alone installation on the wall
PAW-VEN-HTR06	Electrical duct heater 0,6 kW (includes relay)
PAW-VEN-HTR12	Electrical duct heater 1,2 kW (includes relay)

Main features of the residential ventilation unit

- Designed for areas up to approximately 140 m²
- High energy-efficiency rotary heat exchanger with EC - technology fans
- Moisture transfer function to minimize condensation in supply air during wintertime
- The built in humidity sensor in extract air can be used for demand control
- Control via touch display and Startup Wizard for easy commissioning
- Modbus communication via RS-485
- Option to control an Aquarea H Generation onwards heat pump from PAW-A2W-VENTA control panel (PAW-AW-MBS-H and PAW-VEN-ACCPCB required)

Control user-friendly interface

All settings and features accessible via a control panel, integrated into the front cover. The option for connecting one or more external control panels is available.

- Color touch screen with a user-friendly interface
- MANUAL and AUTO mode or choose preferred settings from the pre-configured user modes

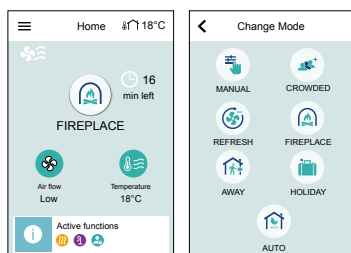

- If Aquarea H and J Generations heat pumps are connected with PAW-A2W-VENTA, the heat pump control options appear on the home screen in a separate tab

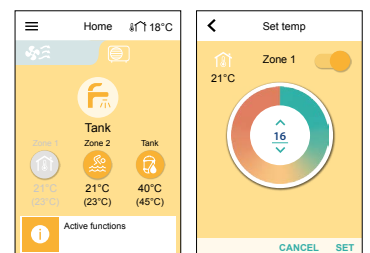

New counter flow ventilation

Controlled mechanical ventilation ensures the supply of fresh air inside a building in order to guarantee a good indoor air quality.



Universal mounting compact unit (Z).

- Suitable for small and medium size apartments, with nominal air flow up to 200 m³/h
- Universal mounting (horizontal or vertical)



Horizontal mounting unit (H).

- Suitable for single family houses, with nominal air flow rates up to 350 m³/h
- Horizontal mounting
- Easily accessible lower panel for maintenance and inspection



Vertical mounting unit (V).

- Suitable for single family houses, with nominal air flow rates up to 350 m³/h
- Vertical mounting
- Easily accessible front panel for maintenance and inspection





Counter flow ventilation		PAW-	VENTX10Z	VENTX15Z	VENTX20H	VENTX20V	VENTX30H	VENTX30V	VENTX40H	VENTX40V
Air flow	Nominal / Max	m³/h	91/130	147/210	109/155	112/170	210/300	210/300	238/340	266/380
Static pressure	Nominal / Max	Pa	50/100	50/100	50/100	50/100	50/100	50/100	50/100	50/100
Type of HEX			Counter flow HRV	Counter flow HRV	Counter flow HRV	Counter flow HRV	Counter flow HRV	Counter flow HRV	Counter flow HRV	Counter flow HRV
Recovery efficiency	%		87	85	86	86	85	86	89	87
Energy class			A	A	A	A	A	A	A	A
Power supply	Voltage	V	230	230	230	230	230	230	230	230
	Phase		Single phase	Single phase	Single phase	Single phase	Single phase	Single phase	Single phase	Single phase
	Frequency	Hz	50	50	50	50	50	50	50	50
Power consumption	Nominal	W	80	140	110	110	180	180	350	350
Sound Power LWA		dB(A)	48	51	49	48	50	50	52	51
Dimensions	HxWxD	mm	255x580x580	255x580x580	260x480x800	510x430x625	295x600x795	590x575x785	290x650x1150	590x735x785
Weight		kg	19	19	25	32	30	38	38	42
Mounting position			Horizontal / Vertical	Horizontal / Vertical	Horizontal	Vertical	Horizontal	Vertical	Horizontal	Vertical
Filter class			ePM1 80%	ePM1 80%	ePM1 80%	ePM1 80%	ePM1 70%	ePM1 70%	ePM1 70%	ePM1 70%
Duct connection		mm	160	160	160	160	160	160	160	160

* Produced by Sinergia.

Accessories	
PAW-VEN-CTRLB	Digital remote control (black). Integrated air quality, temperature and humidity sensors
PAW-VEN-CTRLW	Digital remote control (white). Integrated air quality, temperature and humidity sensors
PAW-VEN-HTR05	Electrical duct heater 0,5 kW, DN160 mm
PAW-VEN-HTR10	Electrical duct heater 1,0 kW, DN160 mm
PAW-VEN-FLT1	Spare F7 filter kit (2 pcs) for models 10Z, 15Z, 20H and 20V
PAW-VEN-FLT2	Spare F7 filter kit (2 pcs) for models 30H and 30V

Accessories	
PAW-VEN-FLT3	Spare F7 filter kit (2 pcs) for models 40H
PAW-VEN-FLT4	Spare F7 filter kit (2 pcs) for models 40V
PAW-VEN-ACFLT1	Activated carbon filter (1 pc) for models 10Z, 15Z, 20H and 20V
PAW-VEN-ACFLT2	Activated carbon filter (1 pc) for models 30H and 30V
PAW-VEN-ACFLT3	Activated carbon filter (1 pc) for models 40H
PAW-VEN-ACFLT4	Activated carbon filter (1 pc) for models 40V

Counter flow ventilation units are equipped with two fans to supply and extract air. A cross-flow heat exchanger recovers the energy contained in the extracted air and transfers it to the supplied air. This significantly reduces the building's energy consumption, while at the same time keeping a good quality of the indoor air.

Balanced ventilation

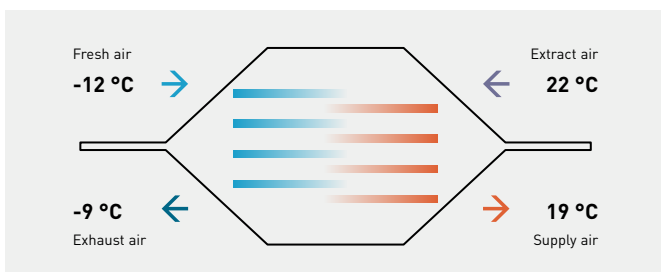

- Suitable for single family houses or apartments with low energy requirements
- High-efficiency sensible heat recovery, thanks to polypropylene counter-flow heat exchanger with large exchange surface and low pressure drop
- High comfort and quiet operation, by using brushless fans with electronic motor and modulating control
- Highly efficient air renewal and filtration, with 80% ePM1 filters
- 3 unit types: compact universal mounting (Z), horizontal mounting (H) and vertical mounting (V)
- Compact dimensions for simplified installation and panel easily accessible for maintenance and inspection

DHW Stand Alone

The wide range of DHW Stand Alone heat pump is a great solution to adapt to any type of family house.



DHW Stand Alone: highly efficient heat pump water heater.

The wall type is available in 100 and 150 L capacities, and the floor-standing in 200 and 270 L. For reaching even more efficient use the 270 L is available in additional coil, it is able to connect solar water production.

- A+ Highly efficient domestic hot water heat pump
- Provides reduced power consumption up to 72% compared with traditional electric water heater
- Easy to install
- Being CFC-free, this water heater is environmentally friendly

1 Energy saving

- Digital control panel with energy consumption monitoring
- Photovoltaic function
- Compatible with ducted fresh air intake installations
- Boiler / Solar Coil (only PAW-DHW270C1F)

2 Comfort

- Different modes of operation based on user needs
- Mode AUTO: Intelligent Temperature Set Point, thanks to monitoring hot water usage
- Mode BOOST, Mode ECO and Mode ABSENCE

3 Durability

- Diamond-quality enamel lining the inner tank
- Pressure relief valve which provides safety if any malfunctions or pressure rise
- Dielectric union preventing corrosion
- Specific lip gasket preventing rust around the flange



Type	Wall-mounted			Floor-standing	
	PAW-DHW100W-1	PAW-DHW150W-1	PAW-DHW200F	PAW-DHW270F	PAW-DHW270C1F
Reference					
Water volume	L	100	150	200	263
Dimension (HxWxD)	mm	1209x522x538	1527x522x538	1617x620x665	1957x620x665
Empty weight	kg	57	66	80	92
Hot and cold connection		¾" M	¾" M	¾" M	¾" M
Anticorrosion system	Anode	Magnesium	Magnesium	Magnesium	Magnesium
Rated water pressure	Mpa (bar)	0,8 (8)	0,8 (8)	0,8 (8)	0,8 (8)
Electrical connection	V / Hz	230/50	230/50	230/50	230/50
Total maximum power	W	1550	1950	2300	2300
Maximal power heat pump	W	350	350	700	700
Power electric heating element	W	1200	1600	1600	1600
Heat pump water temperature range	°C	50 - 62	50 - 62	50 - 62	50 - 62
Heat pump air temperature range	°C	-5 ~ +43	-5 ~ +43	-5 ~ +43	-5 ~ +43
Duct diameter	mm	125	125	160	160
Air flow (without duct)	m³/h	160	160	310/390	310/390
Load losses acceptable on ventilation circuit, without affecting performance	Pa	70	70	25	25
Sound power ¹⁾	dB(A)	45	45	53	53
Refrigerant R134a (wall-mounted) / R513A (floor-standing)	kg	0,52	0,58	0,80	0,86
Refrigerant volume in tons of CO ₂ equivalent	TCO ₂ Eq.	0,74	0,83	0,50	0,54
Refrigerant weight per liter	kg/L	0,0052	0,0039	0,0040	0,0032
Hot water quantity at 40 °C: V40td	L	151,0	182,0	265,5	361,2
Acoustic power ErP ²⁾	dB(A)	45	45	53	53
Energy efficiency class (from A+ to F)		A+	A+	A+	A+
Connectable to PV		Yes	Yes	Yes	Yes
Additional coil exchanger connection		—	—	—	1" M
Additional coil surface	m²	—	—	—	1,2
Warranty of the inner vessel		5 Years	5 Years	5 Years	5 Years
Performance at 7 °C air temperature		[EN 16147] ducted at 25 Pa		[CDC LCIE 103-15/C] ducted at 30 Pa ³⁾	
Coefficient of performance (COP) according load profile		2,66 - M	3,05 - L	2,81 - L	3,16 - XL
Standby input power (P _{es})	W	18	24	32	29
Heating up time (t _h)	h. Min	6h47	10h25	07h11	10h39
Reference hot water temperature (T _{ref})	°C	52,7	53,2	52,7	53,1
Flow rate (air)	m³/h	140	110	320	320
Performance at 15 °C air temperature (EN 16147)					
Coefficient of performance (COP) according load profile		2,88 - M	3,28 - L	3,05 - L	3,61 - XL
Standby input power (P _{es})	W	19	25	30	30
Heating up time (t _h)	h. Min	6h07	9h29	6h24	8h34
Reference hot water temperature (T _{ref})	°C	52,6	53,4	52,8	53,0
Flow rate (air)	m³/h	140	110	320	320

1) According to ISO3744. 2) Compliant with EN 16147 conditions. 3) Performance measured for a water heater from 10 °C to T_{ref} according to the protocol of the NF Electricity Performance Mark specifications No.LCIE 103-15C, selfheating thermodynamic water heaters (based on standard EN 16147). * DHW Stand Alone is produced by C.I.C.E.

Accessories

PAW-DHW-STAND Rack for suspended device for 100 and 150 liters models

Ideal for small surfaces

Suitable for all installations (adapted to small surfaces, low ceiling, corner).

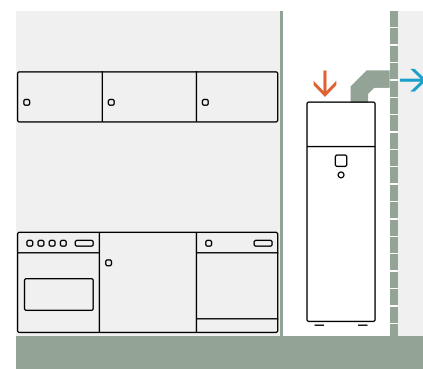
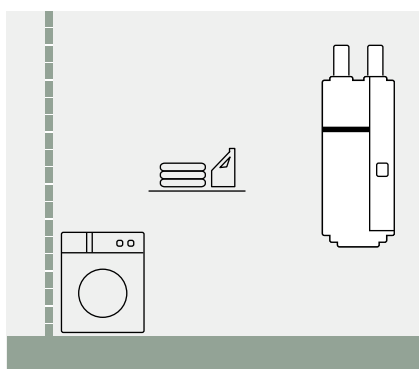

Accessories and control

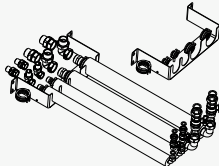
<p>Dual controller system</p>	<p>All in One accessories</p>
	
<p>Additional remote controller for K and L Generations</p> <p>-----</p> <p>CZ-RTW1</p>	<p>Flexible pipings and wall mounting plate for All in One J Generation (not compatible with WH-ADC0309J3E5C).</p> <p>-----</p> <p>PAW-ADC-PREKIT-1</p>

Special outdoor supports





		
<p>Tray for condenser water compatible with outdoor elevation platform.</p> <p>-----</p> <p>PAW-WTRAY</p>	<p>Outdoor elevation platform. Dimension (HxWxD): 400x900x400 mm</p> <p>-----</p> <p>PAW-GRDSTD40</p>	<p>Outdoor base ground support for noise and vibration absorption. Dimension (HxWxD): 600x95x130 mm Safe working load: 500 kg</p> <p>-----</p> <p>PAW-GRDBSE20</p>

PCB's for additional functions

Deice accessories

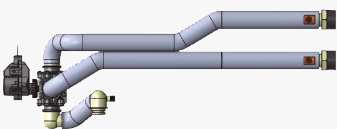
		
<p>PCB for advanced functions in H and J Generations.</p> <p>-----</p> <p>CZ-NS4P</p> <p>NEW PCB for advanced functions in K and L Generations.</p> <p>-----</p> <p>CZ-NS5P</p>	<p>Base pan heater for all old Bi-bloc and Mono-bloc (not for the 3 and 5 kW).</p> <p>-----</p> <p>CZ-NE1P</p> <p>Base pan heater for Bi-bloc 3 and 5 kW (except L Generation) and 7 and 9 kW K Generation.</p> <p>-----</p> <p>CZ-NE2P</p>	<p>Base pan heater for H and J Generations.</p> <p>-----</p> <p>CZ-NE3P</p> <p>NEW Base pan heater for 5, 7 and 9 kW L Generation.</p> <p>-----</p> <p>CZ-NE4P</p>

Hydraulic accessories

			
<p>3 way valve kit for inside of hydrokit for H and J Generations.</p> <p>-----</p> <p>CZ-NV1</p> <p>NEW 3 way valve kit for inside of hydrokit for K and L Generations.</p> <p>-----</p> <p>CZ-NV2</p>	<p>3 way valve for DHW tanks.</p> <p>-----</p> <p>PAW-3WYVLV-HW</p>	<p>1 anti-freeze valve. It is required to order 2 valves per system.</p> <p>-----</p> <p>PAW-A2W-AFVLV</p>	<p>Optional magnet for the water filter in H Generation models.</p> <p>-----</p> <p>PAW-A2W-MGTFILTER</p>

Accessories interfaces



Aquaarea Smart Cloud for remote control and maintenance through wireless or wired LAN.

CZ-TAW1B

10 m extension cable for CZ-TAW1B.

CZ-TAW1-CBL



NEW External meter gateway.

PAW-A2W-EXTMETER



KNX interface for H Generation onwards (Intesis).

PAW-AW-KNX-H



Modbus interface for H Generation onwards (Intesis).

PAW-AW-MBS-H



NEW KNX interface for H Generation onwards (Airzone).

PAW-AZAW-KNX-1



NEW Modbus interface for H Generation onwards (Airzone).

PAW-AZAW-MBS-1

Cascade manager



Cascade manager for Aquaarea Heat Pumps.

PAW-A2W-CMH-2

Room thermostats



Wired LCD room thermostat with weekly timer.

PAW-A2W-RTWIRED



Wireless LCD room thermostat with weekly timer.

PAW-A2W-RTWIREFLESS

Sensors for Aquaarea H Generation onwards



Outdoor ambient sensor.

PAW-A2W-TS0D



Zone room sensor.

PAW-A2W-TSRT



Zone water sensor.

PAW-A2W-TSHC



Solar sensor.

PAW-A2W-TSSO



Buffer tank sensor.



Zone water sensor PAW-A2W-TSHC is also required to operate buffer tank sensor.

PAW-A2W-TSBU

Smart fan coil accessories

<p>Kits of 2 legs to protect the water pipings.</p> <p>----- PAW-AAIR-LEGS-1</p>	<p>Motor connection cable for units with hydraulic connections on the right.</p> <p>----- PAW-AAIR-RHCABLE</p>
---	---



Fan coil accessories

 <p>Advanced wired remote controller for fan coil.</p> <p>----- PAW-FC-RC1</p>	 <p>Wired remote controller with touch control for 2-pipe and 4-pipe, EC fan coil (control + Modbus).</p> <p>----- PAW-FC-907EC</p> <p>Wired remote controller with touch control for 2-pipe, AC fan coil (control only).</p> <p>----- PAW-FC-907AC</p>	 <p>Wired remote controller for 2-pipe and 4-pipe, EC fan coil (control + Modbus).</p> <p>----- PAW-FC-903EC</p> <p>Wired remote controller for 2-pipe, AC fan coil (control only).</p> <p>----- PAW-FC-903AC</p>
--	--	--

<p>2 way valve + drain pan for ducted models 010-060.</p> <p>----- PAW-FC-2WY-11/55-1</p>	<p>2 way valve + drain pan for ducted models 070-080.</p> <p>----- PAW-FC-2WY-65/90-1</p>	<p>2 way valve + drain pan for ducted model F040.</p> <p>----- PAW-FC-2WY-F040</p>	<p>2 way valve for wall-mounted.</p> <p>----- PAW-FC2-2WY-K007</p>
<p>3 way valve + drain pan for ducted models 010-060.</p> <p>----- PAW-FC-3WY-11/55-1</p>	<p>3 way valve + drain pan for ducted models 070-080.</p> <p>----- PAW-FC-3WY-65/90-1</p>	<p>3 way valve + drain pan for ducted model F040.</p> <p>----- PAW-FC-3WY-F040</p>	<p>3 way valve for wall-mounted.</p> <p>----- PAW-FC2-3WY-K007</p>





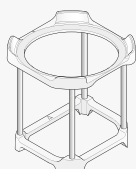

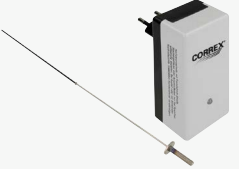

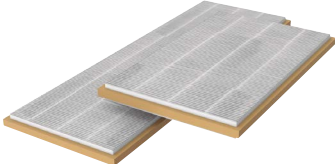

Sanitary tank accessories

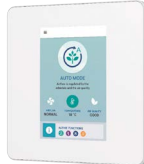
DHW Stand Alone accessories



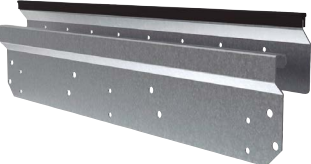

 <p>Tank sensor with 6 m cable length.</p> <p>----- PAW-TS1</p>	 <p>Tank sensor with 20 m cable length.</p> <p>----- PAW-TS2</p>	 <p>Tank sensor with 6 m cable length and only 6 mm diameter.</p> <p>----- PAW-TS4</p>	 <p>Rack for suspended device for 100 and 150 liters models.</p> <p>----- PAW-DHW-STAND</p>
---	--	--	---

 <p>Temperature sensor kit for third party tank (with copper pocket and 6 m length sensor cable).</p> <p>----- CZ-TK1</p>	<p>NEW impressed current anode for 200 L Stainless Steel tanks.</p> <p>----- PAW-EANODE2</p>	 <p>NEW impressed current anode for 300 L Stainless Steel tanks.</p> <p>----- PAW-EANODE3</p>	
---	---	---	--

Heat recovery ventilation accessories

 <p>Supply and extract filters kit.</p> <p>-----</p> <p>PAW-VEN-FLTKIT</p>	 <p>Optional PCB for additional functions.</p> <p>-----</p> <p>PAW-VEN-ACPCB</p>	 <p>HRV touch control panel. White frame (cable must be ordered separately).</p> <p>-----</p> <p>PAW-VEN-DPL</p>	 <p>Cable with plug for electrical connection between unit and control panel, type CE and CD (12 m).</p> <p>-----</p> <p>PAW-VEN-CBLEXT12</p>
 <p>Twin plugs for installation of several control panels type CD or CE for one unit.</p> <p>-----</p> <p>PAW-VEN-DIVPLG</p>	 <p>HRV touch control panel wall-mounted kit.</p> <p>-----</p> <p>PAW-VEN-DPLBOX</p>	 <p>CO₂ RH wall-mounted sensor.</p> <p>-----</p> <p>PAW-VEN-S-CO2RH-W</p>	 <p>CO₂ wall-mounted sensor.</p> <p>-----</p> <p>PAW-VEN-S-CO2-W</p>
 <p>CO₂ duct sensor.</p> <p>-----</p> <p>PAW-VEN-S-CO2-D</p>	 <p>Wall bracket kit for stand-alone installation on the wall.</p> <p>-----</p> <p>PAW-VEN-WBRK</p>	 <p>Electrical duct heater 0,6 kW (includes relay).</p> <p>-----</p> <p>PAW-VEN-HTR06</p>	 <p>Electrical duct heater 1,2 kW (includes relay).</p> <p>-----</p> <p>PAW-VEN-HTR12</p>

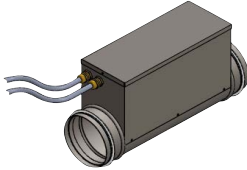
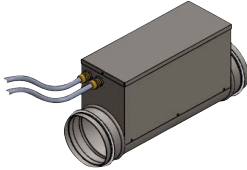
NEW counter flow ventilation accessories

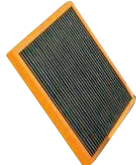
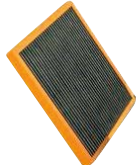
 <p>Digital remote control (black). Integrated air quality, temperature and humidity sensors.</p> <p>-----</p> <p>PAW-VEN-CTRLB</p>	 <p>Digital remote control (white). Integrated air quality, temperature and humidity sensors.</p> <p>-----</p> <p>PAW-VEN-CTRLW</p>	 <p>Electrical duct heater 0,5 kW, DN160 mm.</p> <p>-----</p> <p>PAW-VEN-HTR05</p>	 <p>Electrical duct heater 1,0 kW, DN160 mm.</p> <p>-----</p> <p>PAW-VEN-HTR10</p>
 <p>Spare F7 filter kit (2 pcs) for models 10Z, 15Z, 20H and 20V.</p> <p>-----</p> <p>PAW-VEN-FLT1</p> <p>Spare F7 filter kit (2 pcs) for models 40H.</p> <p>-----</p> <p>PAW-VEN-FLT3</p>	 <p>Spare F7 filter kit (2 pcs) for models 30H and 30V.</p> <p>-----</p> <p>PAW-VEN-FLT2</p> <p>Spare F7 filter kit (2 pcs) for models 40V.</p> <p>-----</p> <p>PAW-VEN-FLT4</p>	 <p>Activated carbon filter (1 pc) for models 10Z, 15Z, 20H and 20V.</p> <p>-----</p> <p>PAW-VEN-ACFLT1</p> <p>Activated carbon filter (1 pc) for models 40H.</p> <p>-----</p> <p>PAW-VEN-ACFLT3</p>	 <p>Activated carbon filter (1 pc) for models 30H and 30V.</p> <p>-----</p> <p>PAW-VEN-ACFLT2</p> <p>Activated carbon filter (1 pc) for models 40V.</p> <p>-----</p> <p>PAW-VEN-ACFLT4</p>

Heating and cooling capacity tables

Based on outlet temperature and outside temperature.

Aquarea High Performance Hydraulic Split All in One L Generation Single phase. Heating and Cooling - R290

WH-WDG05LE5UK

Tamb	HC	IP	COP	HC	IP	COP	HC	IP	COP	HC	IP	COP
LWC	35	35	35	45	45	45	55	55	55	65	65	65
-15	5,00	1,94	2,58	5,00	2,31	2,16	5,00	2,63	1,90	4,60	2,88	1,60
-7	5,00	1,66	3,01	5,00	1,94	2,58	5,00	2,36	2,12	5,00	2,62	1,91
2	5,00	1,42	3,52	5,00	1,71	2,92	5,00	2,14	2,34	5,00	2,54	1,97
7	5,00	0,99	5,05	5,00	1,27	3,94	5,00	1,63	3,07	5,00	2,03	2,46

WH-WDG07LE5UK

Tamb	HC	IP	COP	HC	IP	COP	HC	IP	COP	HC	IP	COP
LWC	35	35	35	45	45	45	55	55	55	65	65	65
-15	6,00	2,50	2,40	5,50	2,60	2,12	5,20	2,89	1,80	4,80	3,00	1,60
-7	5,80	1,93	3,01	5,80	2,32	2,50	5,80	2,74	2,12	5,70	3,16	1,80
2	6,85	2,00	3,43	6,60	2,34	2,82	6,25	2,67	2,34	5,60	2,80	2,00
7	7,00	1,42	4,93	7,00	1,90	3,68	7,00	2,35	2,98	6,60	2,85	2,32

WH-WDG09LE5UK

Tamb	HC	IP	COP	HC	IP	COP	HC	IP	COP	HC	IP	COP
LWC	35	35	35	45	45	45	55	55	55	65	65	65
-15	7,40	3,20	2,31	6,80	3,40	2,00	6,30	3,55	1,77	5,60	3,55	1,58
-7	7,00	2,50	2,80	7,00	2,98	2,35	7,00	3,29	2,13	6,50	3,53	1,84
2	7,00	2,05	3,41	7,00	2,50	2,80	7,00	2,90	2,41	6,70	3,35	2,00
7	9,00	1,98	4,55	9,00	2,58	3,49	8,90	2,94	3,03	8,90	3,56	2,50

Aquarea High Performance Hydraulic Split All in One L Generation Single phase. Heating and Cooling - R290

WH-WDG05LE5UK

Tamb	CC	IP	EER	CC	IP	EER
LWC	7	7	7	18	18	18
35	5,00	1,55	3,23	5,00	1,00	5,00

WH-WDG07LE5UK

Tamb	CC	IP	EER	CC	IP	EER
LWC	7	7	7	18	18	18
35	7,00	2,31	3,03	7,00	1,48	4,73

WH-WDG09LE5UK

Tamb	CC	IP	EER	CC	IP	EER
LWC	7	7	7	18	18	18
35	8,20	2,91	2,82	9,00	2,15	4,19

Tamb: Ambient Temperature [°C]. LWC: Leaving Water Condenser Temperature [°C]. HC: Heating Capacity [kW]. CC: Cooling Capacity [kW]. IP: Input Power [kW]. This data is measured by Panasonic in accordance with EN14511-2 standard. This data is for reference purpose only, and does not guarantee the performance.

Heating and cooling capacity tables

Based on outlet temperature and outside temperature.

Aquarea High Performance Bi-bloc K Generation Single phase. Heating and Cooling - R32

WH-UDZ03KE5

Tamb	HC	IP	COP	HC	IP	COP
LWC	35	35	35	55	55	55
-15	3,20	1,37	2,34	2,75	1,92	1,43
-7	3,30	1,18	2,80	3,20	1,79	1,79
2	3,20	0,88	3,64	3,20	1,46	2,19
7	3,20	0,60	5,33	3,20	1,14	2,81

WH-UDZ05KE5

Tamb	HC	IP	COP	HC	IP	COP
LWC	35	35	35	55	55	55
-15	5,00	2,11	2,37	4,30	2,61	1,65
-7	5,00	1,79	2,79	5,00	2,65	1,89
2	5,00	1,40	3,57	5,00	2,18	2,29
7	5,00	0,98	5,10	5,00	1,65	3,03

WH-UDZ07KE5

Tamb	HC	IP	COP	HC	IP	COP
LWC	35	35	35	55	55	55
-15	5,60	2,38	2,35	5,00	3,20	1,56
-7	5,75	1,95	2,95	5,35	2,70	1,98
2	6,85	2,00	3,43	6,25	2,80	2,23
7	7,00	1,44	4,86	7,00	2,40	2,92

WH-UDZ09KE5

Tamb	HC	IP	COP	HC	IP	COP
LWC	35	35	35	55	55	55
-15	7,40	3,20	2,31	5,40	3,42	1,58
-7	6,25	2,20	2,84	5,90	3,06	1,93
2	7,00	2,06	3,40	6,30	2,89	2,18
7	9,00	1,98	4,55	8,90	3,04	2,93

Aquarea High Performance Bi-bloc K Generation Single phase. Heating and Cooling - R32

WH-UDZ03KE5

Tamb	CC	IP	EER	CC	IP	EER
LWC	7	7	7	18	18	18
35						

WH-UDZ05KE5

Tamb	CC	IP	EER	CC	IP	EER
LWC	7	7	7	18	18	18
35	5,00	1,64	3,05	5,00	1,02	4,90

WH-UDZ07KE5

Tamb	CC	IP	EER	CC	IP	EER
LWC	7	7	7	18	18	18
35	6,70	2,21	3,03	6,70	1,42	4,72

WH-UDZ09KE5

Tamb	CC	IP	EER	CC	IP	EER
LWC	7	7	7	18	18	18
35	8,20	3,02	2,72	9,00	2,15	4,18

Tamb: Ambient Temperature [°C]. LWC: Leaving Water Condenser Temperature [°C]. HC: Heating Capacity (kW). CC: Cooling Capacity (kW). IP: Input Power (kW).
This data is measured by Panasonic in accordance with EN14511-2 standard. This data is for reference purpose only, and does not guarantee the performance.

Heating and cooling capacity tables

Based on outlet temperature and outside temperature.

Aquarea High Performance Bi-bloc J Generation Single phase. Heating and Cooling · R32

WH-UD03JE5

Tamb	HC	IP	COP	HC	IP	COP	HC	IP	COP	HC	IP	COP	HC	IP	COP
LWC	25	25	25	35	35	35	45	45	45	55	55	55	60	60	60
-20	2,50	1,11	2,25	2,52	1,31	1,92	2,24	1,59	1,41	2,12	1,80	1,18	—	—	—
-15	3,00	1,14	2,63	3,20	1,37	2,34	3,00	1,62	1,85	2,75	1,92	1,43	—	—	—
-7	2,99	0,91	3,29	3,30	1,18	2,80	3,25	1,47	2,21	3,20	1,79	1,79	3,00	1,88	1,60
2	2,92	0,69	4,23	3,20	0,88	3,64	3,20	1,13	2,83	3,20	1,46	2,19	3,15	1,67	1,89
7	3,09	0,49	6,31	3,20	0,60	5,33	3,20	0,84	3,81	3,20	1,14	2,81	2,95	1,22	2,42
25	3,27	0,23	14,22	3,27	0,38	8,61	3,61	0,63	5,73	4,06	1,11	3,66	4,03	1,14	3,54

WH-UD05JE5

Tamb	HC	IP	COP	HC	IP	COP	HC	IP	COP	HC	IP	COP	HC	IP	COP
LWC	25	25	25	35	35	35	45	45	45	55	55	55	60	60	60
-20	3,60	1,57	2,29	3,51	1,81	1,94	3,16	1,99	1,59	2,46	2,11	1,17	—	—	—
-15	4,46	1,72	2,59	4,20	1,93	2,18	3,75	2,18	1,72	3,00	2,12	1,42	—	—	—
-7	4,18	1,33	3,14	4,20	1,62	2,59	3,80	1,82	2,09	3,55	2,08	1,71	3,25	2,15	1,51
2	4,07	1,01	4,03	4,20	1,32	3,18	4,20	1,64	2,56	4,10	2,06	1,99	4,10	2,21	1,86
7	5,20	0,83	6,27	5,00	1,00	5,00	5,00	1,41	3,55	5,00	1,84	2,72	4,25	2,10	2,02
25	5,00	0,52	9,62	5,00	0,72	6,94	5,30	0,98	5,41	5,60	1,27	4,41	4,80	1,27	3,78

WH-UD07JE5

Tamb	HC	IP	COP	HC	IP	COP	HC	IP	COP	HC	IP	COP	HC	IP	COP
LWC	25	25	25	35	35	35	45	45	45	55	55	55	60	60	60
-20	4,33	1,64	2,64	3,98	1,88	2,12	3,83	2,26	1,69	3,30	2,77	1,19	—	—	—
-15	5,16	1,69	3,05	4,75	2,00	2,38	4,65	2,40	1,94	4,50	2,96	1,52	—	—	—
-7	5,64	1,56	3,62	5,60	1,95	2,87	5,50	2,30	2,39	5,25	2,70	1,94	4,98	2,90	1,72
2	6,80	1,57	4,33	6,85	2,01	3,41	6,75	2,40	2,81	6,20	2,80	2,21	6,18	2,91	2,12
7	7,55	1,15	6,57	7,00	1,47	4,76	7,00	1,96	3,57	7,00	2,48	2,82	6,86	2,75	2,49
25	7,00	0,62	11,29	6,88	0,90	7,64	7,00	1,33	5,26	6,92	1,75	3,95	6,83	1,90	3,59

Aquarea High Performance Bi-bloc J Generation Single phase. Heating and Cooling · R32

Outdoor		WH-UD03JE5									WH-UD05JE5								
Tamb	CC	IP	EER	CC	IP	EER	CC	IP	EER	CC	IP	EER	CC	IP	EER	CC	IP	EER	
LWC	7	7	7	14	14	14	18	18	18	7	7	7	14	14	14	18	18	18	
16	3,56	0,57	6,25	4,32	0,55	7,85	3,47	0,41	8,46	3,59	0,56	6,41	4,23	0,54	7,83	4,79	0,52	9,21	
25	3,29	0,73	4,51	4,06	0,72	5,64	3,27	0,52	6,29	4,61	1,18	3,91	5,54	1,21	4,58	5,23	0,90	5,81	
35	3,20	0,91	3,52	3,56	0,93	3,83	3,20	0,68	4,71	4,50	1,50	3,00	5,08	1,51	3,36	4,80	1,12	4,29	
43	2,68	1,06	2,53	3,34	1,09	3,06	2,79	0,82	3,40	3,77	1,71	2,20	4,94	1,80	2,74	4,30	1,35	3,19	
Outdoor		WH-UD07JE5																	
Tamb	CC	IP	EER	CC	IP	EER	CC	IP	EER										
LWC	7	7	7	14	14	14	18	18	18										
16	5,20	0,81	6,42	6,62	0,73	9,07	7,04	0,72	9,78										
25	7,40	1,73	4,28	9,30	1,78	5,22	7,65	1,10	6,95										
35	6,70	2,21	3,03	8,10	2,23	3,63	6,70	1,42	4,72										
43	4,50	1,99	2,26	5,44	2,00	2,72	5,10	1,71	2,98										

Tamb: Ambient Temperature [°C]. LWC: Leaving Water Condenser Temperature [°C]. HC: Heating Capacity [kW]. CC: Cooling Capacity [kW]. IP: Input Power [kW]. This data is measured by Panasonic in accordance with EN14511-2 standard. This data is for reference purpose only, and does not guarantee the performance.

Aquarea High Performance Mono-bloc J Generation Single phase. Heating and Cooling - MDC · R32

WH-MDC05J3E5

Tamb	HC	IP	COP	HC	IP	COP	HC	IP	COP	HC	IP	COP	HC	IP	COP
LWC	25	25	25	35	35	35	45	45	45	55	55	55	60	60	60
-20	4,37	1,73	2,53	4,16	2,03	2,05	3,84	2,37	1,62	3,43	2,64	1,30	—	—	—
-15	5,13	1,78	2,88	5,00	2,17	2,30	4,75	2,51	1,89	3,70	2,45	1,51	—	—	—
-7	5,17	1,49	3,47	5,00	1,80	2,78	4,80	2,16	2,22	5,00	2,70	1,85	4,68	2,71	1,73
2	5,00	1,11	4,50	5,00	1,40	3,57	5,00	1,81	2,76	5,00	2,20	2,27	4,80	2,40	2,00
7	5,09	0,78	6,53	5,00	0,99	5,05	5,00	1,31	3,82	5,00	1,66	3,01	4,58	1,90	2,41
25	4,96	0,77	6,44	5,04	0,90	5,60	5,31	1,16	4,58	5,61	1,34	4,19	5,15	1,33	3,87

WH-MDC07J3E5

Tamb	HC	IP	COP	HC	IP	COP	HC	IP	COP	HC	IP	COP	HC	IP	COP
LWC	25	25	25	35	35	35	45	45	45	55	55	55	60	60	60
-20	4,86	2,03	2,39	4,66	2,35	1,98	4,44	2,75	1,61	4,23	3,13	1,35	—	—	—
-15	5,80	2,11	2,75	5,60	2,40	2,33	5,30	2,84	1,87	5,00	3,32	1,51	—	—	—
-7	6,76	2,07	3,27	6,80	2,42	2,81	6,30	2,82	2,23	6,30	3,39	1,86	4,74	2,76	1,72
2	6,83	1,66	4,11	7,00	2,06	3,40	6,85	2,50	2,74	6,30	2,92	2,16	4,80	2,40	2,00
7	7,32	1,19	6,15	7,00	1,47	4,76	7,00	1,96	3,57	7,00	2,48	2,82	6,18	2,44	2,53
25	6,80	0,64	10,63	6,67	0,93	7,17	6,79	1,38	4,92	6,70	1,80	3,72	6,22	1,78	3,49

WH-MDC09J3E5

Tamb	HC	IP	COP	HC	IP	COP	HC	IP	COP	HC	IP	COP	HC	IP	COP
LWC	25	25	25	35	35	35	45	45	45	55	55	55	60	60	60
-20	5,33	2,36	2,26	6,43	3,60	1,79	5,78	3,83	1,51	4,83	3,64	1,33	—	—	—
-15	7,76	3,20	2,43	7,60	3,41	2,23	7,00	3,71	1,89	5,60	3,80	1,47	—	—	—
-7	7,39	2,45	3,02	7,50	2,85	2,63	7,30	3,37	2,17	7,00	3,89	1,80	6,44	3,67	1,75
2	7,38	1,89	3,90	7,45	2,38	3,13	7,00	2,85	2,46	7,00	3,30	2,12	5,46	2,72	2,01
7	9,15	1,59	5,75	9,00	2,01	4,48	9,00	2,61	3,45	8,95	3,22	2,78	7,25	2,87	2,53
25	8,02	0,98	8,18	7,88	1,32	5,97	8,46	1,86	4,55	7,60	2,03	3,74	6,30	1,87	3,37

Aquarea High Performance Mono-bloc J Generation Single phase. Heating and Cooling - MDC · R32

WH-MDC05J3E5

Tamb	CC	IP	EER	CC	IP	EER	CC	IP	EER
LWC	7	7	7	14	14	14	18	18	18
16	5,18	0,82	6,32	6,17	0,84	7,35	5,78	0,60	9,63
25	5,38	1,22	4,41	6,64	1,25	5,31	5,55	0,78	7,12
35	5,00	1,54	3,25	5,86	1,61	3,64	5,00	0,99	5,05
43	4,19	1,85	2,26	5,36	1,92	2,79	4,37	1,30	3,36

WH-MDC07J3E5

Tamb	CC	IP	EER	CC	IP	EER	CC	IP	EER
LWC	7	7	7	14	14	14	18	18	18
16	5,38	0,83	6,48	6,69	0,85	7,87	7,65	0,76	10,07
25	6,96	1,82	3,82	9,06	1,98	4,58	7,58	1,23	6,16
35	7,00	2,29	3,06	8,37	2,47	3,39	7,00	1,48	4,73
43	5,60	2,55	2,20	6,87	2,58	2,66	6,10	1,88	3,24

WH-MDC09J3E5

Tamb	CC	IP	EER	CC	IP	EER	CC	IP	EER
LWC	7	7	7	14	14	14	18	18	18
16	6,89	1,21	5,69	8,65	1,23	7,03	9,82	1,19	8,25
25	9,50	2,84	3,35	11,55	3,06	3,77	9,68	1,82	5,32
35	9,00	3,32	2,71	10,10	3,51	2,88	9,00	2,12	4,25
43	5,42	2,56	2,12	6,56	2,56	2,56	7,40	2,56	2,89

Tamb: Ambient Temperature [°C]. LWC: Leaving Water Condenser Temperature [°C]. HC: Heating Capacity (kW). CC: Cooling Capacity (kW). IP: Input Power (kW).
This data is measured by Panasonic in accordance with EN14511-2 standard. This data is for reference purpose only, and does not guarantee the performance.

Heating and cooling capacity tables

Based on outlet temperature and outside temperature.

Aquarea High Performance Mono-bloc H Generation Single phase. Heating and Cooling - MDC · R410A

WH-MDC12H6E5																		
Tamb	HC	IP	COP	HC	IP	COP	HC	IP	COP	HC	IP	COP	HC	IP	COP	HC	IP	COP
LWC	30	30	30	35	35	35	40	40	40	45	45	45	50	50	50	55	55	55
-15	9,30	3,46	2,69	8,90	3,62	2,46	8,50	3,79	2,24	8,10	3,95	2,05	—	—	—	7,00	4,10	1,71
-7	10,40	3,37	3,09	10,00	3,66	2,73	9,60	3,95	2,43	9,20	4,24	2,17	—	—	—	8,20	4,21	1,95
2	11,80	3,10	3,81	11,40	3,31	3,44	11,00	3,53	3,12	10,60	3,74	2,83	—	—	—	9,10	4,08	2,23
7	12,00	2,10	5,71	12,00	2,53	4,74	12,00	2,96	4,05	12,00	3,39	3,54	—	—	—	12,00	4,10	2,93
12	12,00	1,38	8,70	12,00	1,66	7,23	11,80	1,94	6,08	11,70	2,23	5,25	—	—	—	11,40	2,74	4,16

WH-MDC16H6E5																		
Tamb	HC	IP	COP	HC	IP	COP	HC	IP	COP	HC	IP	COP	HC	IP	COP	HC	IP	COP
LWC	30	30	30	35	35	35	40	40	40	45	45	45	50	50	50	55	55	55
-15	10,60	4,09	2,59	10,30	4,38	2,35	10,00	4,67	2,14	9,70	4,96	1,96	7,90	4,84	1,63	—	—	—
-7	11,90	4,03	2,95	11,40	4,43	2,57	10,80	4,83	2,24	10,30	5,22	1,97	9,00	4,88	1,84	—	—	—
2	13,50	13,74	0,98	13,00	3,96	3,28	12,40	4,18	2,97	11,90	4,40	2,70	9,80	4,44	2,21	—	—	—
7	16,00	3,21	4,98	16,00	3,74	4,28	16,00	4,27	3,75	16,00	4,80	3,33	14,50	5,33	2,72	—	—	—
12	16,00	2,31	6,93	16,00	2,69	5,95	16,00	3,07	5,21	16,00	3,45	4,64	15,90	3,89	4,09	—	—	—

Aquarea High Performance Mono-bloc H Generation Single phase. Heating and Cooling - MDC · R410A

WH-MDC12H6E5									
Tamb	CC	IP	EER	CC	IP	EER	CC	IP	EER
LWC	7	7	7	14	14	14	18	18	18
16	7,86	1,18	6,66	13,15	2,05	6,41	10,00	1,73	5,78
25	12,08	2,90	4,17	15,70	3,05	5,15	10,00	1,97	5,08
35	10,00	3,56	2,81	12,00	3,67	3,27	10,00	2,15	4,65
43	7,80	3,80	2,05	11,10	3,19	3,48	8,00	2,85	2,81

WH-MDC16H6E5									
Tamb	CC	IP	EER	CC	IP	EER	CC	IP	EER
LWC	7	7	7	14	14	14	18	18	18
16	9,20	1,62	5,68	16,40	2,58	6,36	12,20	2,45	4,98
25	14,40	3,92	3,67	19,20	3,83	5,01	12,20	2,79	4,37
35	12,20	4,76	2,56	15,00	4,98	3,01	12,20	2,96	4,12
43	7,75	3,40	2,28	13,80	5,95	2,32	9,70	4,00	2,43

Aquarea T-CAP Bi-bloc K Generation Single phase. Heating and Cooling · R32

WH-UXZ09KE5									
Tamb	HC	IP	COP	HC	IP	COP	HC	IP	COP
LWC	35	35	35	45	45	45	55	55	55
-15	9,00	3,45	2,61	9,00	4,30	2,09	9,00	4,95	1,82
-7	9,00	3,00	3,00	9,00	3,82	2,36	9,00	4,28	2,10
2	9,00	2,44	3,69	9,00	3,05	2,95	9,00	3,90	2,31
7	9,00	1,79	5,03	9,00	2,42	3,72	9,00	2,93	3,07

WH-UXZ12KE5									
Tamb	HC	IP	COP	HC	IP	COP	HC	IP	COP
LWC	35	35	35	45	45	45	55	55	55
-15	12,00	4,90	2,45	11,00	5,38	2,04	10,50	6,20	1,69
-7	12,00	4,41	2,72	12,00	5,54	2,17	12,00	6,00	2,00
2	12,00	3,49	3,44	12,00	4,25	2,82	12,00	5,24	2,29
7	12,10	2,50	4,84	12,10	3,38	3,58	12,10	3,98	3,04

Aquarea T-CAP Bi-bloc K Generation Single phase. Heating and Cooling · R32

WH-UXZ09KE5						
Tamb	CC	IP	EER	CC	IP	EER
LWC	7	7	7	18	18	18
35	8,80	2,83	3,11	8,80	1,90	4,63

WH-UXZ12KE5						
Tamb	CC	IP	EER	CC	IP	EER
LWC	7	7	7	18	18	18
35	10,70	4,00	2,68	10,70	2,73	3,92

Tamb: Ambient Temperature [°C]. LWC: Leaving Water Condenser Temperature [°C]. HC: Heating Capacity [kW]. CC: Cooling Capacity [kW]. IP: Input Power [kW]. This data is measured by Panasonic in accordance with EN14511-2 standard. This data is for reference purpose only, and does not guarantee the performance.

Aquarea T-CAP Mono-bloc J Generation Single phase / Three phase. Heating and Cooling - MXC · R32

WH-MXC09J3E5

Tamb	HC	IP	COP	HC	IP	COP	HC	IP	COP	HC	IP	COP	HC	IP	COP
LWC	25	25	25	35	35	35	45	45	45	55	55	55	60	60	60
-20	9,00	3,44	2,62	9,00	3,95	2,28	9,00	4,65	1,94	7,90	5,58	1,42	—	—	—
-15	9,00	2,98	3,02	9,00	3,41	2,64	9,00	4,04	2,23	9,00	4,83	1,86	8,70	5,37	1,62
-7	10,50	2,72	3,86	9,00	2,92	3,08	9,00	3,54	2,54	9,00	4,24	2,12	9,00	4,62	1,95
2	10,80	2,14	5,05	9,00	2,36	3,81	9,00	2,91	3,09	9,00	3,55	2,54	9,00	4,05	2,22
7	9,00	1,38	6,52	9,00	1,77	5,08	9,00	2,37	3,80	9,00	2,92	3,08	9,00	3,29	2,74
25	9,00	0,77	11,69	9,00	1,00	9,00	10,00	1,67	5,99	10,00	2,28	4,39	11,00	2,86	3,85

WH-MXC12J6E5

Tamb	HC	IP	COP	HC	IP	COP	HC	IP	COP	HC	IP	COP	HC	IP	COP
LWC	25	25	25	35	35	35	45	45	45	55	55	55	60	60	60
-20	12,00	5,02	2,39	12,00	5,80	2,07	11,00	5,95	1,85	10,00	6,50	1,54	—	—	—
-15	12,00	4,14	2,90	12,00	4,83	2,48	11,00	5,20	2,12	10,50	6,00	1,75	8,90	6,30	1,41
-7	13,50	4,30	3,14	12,00	4,25	2,82	12,00	5,02	2,39	12,00	6,00	2,00	11,00	6,30	1,75
2	14,50	3,23	4,49	12,00	3,40	3,53	12,00	4,20	2,86	12,00	4,95	2,42	12,00	5,77	2,08
7	12,00	2,00	6,00	12,00	2,50	4,80	12,00	3,24	3,70	12,00	3,94	3,05	12,00	4,52	2,65
25	12,00	1,20	10,00	12,00	1,49	8,05	12,00	2,10	5,71	12,00	2,75	4,36	12,00	3,11	3,86

WH-MXC09J3E8

Tamb	HC	IP	COP	HC	IP	COP	HC	IP	COP	HC	IP	COP	HC	IP	COP
LWC	25	25	25	35	35	35	45	45	45	55	55	55	60	60	60
-20	9,00	3,44	2,62	9,00	3,95	2,28	9,00	4,65	1,94	7,90	5,58	1,42	—	—	—
-15	9,00	2,98	3,02	9,00	3,41	2,64	9,00	4,04	2,23	9,00	4,83	1,86	8,70	5,37	1,62
-7	10,50	2,72	3,86	9,00	2,92	3,08	9,00	3,54	2,54	9,00	4,24	2,12	9,00	4,62	1,95
2	10,80	2,14	5,05	9,00	2,36	3,81	9,00	2,91	3,09	9,00	3,55	2,54	9,00	4,05	2,22
7	9,00	1,38	6,52	9,00	1,77	5,08	9,00	2,37	3,80	9,00	2,92	3,08	9,00	3,29	2,74
25	9,00	0,77	11,69	9,00	1,00	9,00	10,00	1,67	5,99	10,00	2,28	4,39	11,00	2,86	3,85

WH-MXC12J9E8

Tamb	HC	IP	COP	HC	IP	COP	HC	IP	COP	HC	IP	COP	HC	IP	COP
LWC	25	25	25	35	35	35	45	45	45	55	55	55	60	60	60
-20	12,00	5,02	2,39	12,00	5,80	2,07	10,50	5,75	1,83	9,20	5,80	1,59	—	—	—
-15	12,00	4,14	2,90	12,00	4,83	2,48	12,00	5,67	2,12	11,10	6,35	1,75	8,70	6,20	1,40
-7	13,50	4,30	3,14	12,00	4,25	2,82	12,00	5,02	2,39	12,00	6,00	2,00	11,00	6,30	1,75
2	14,50	3,23	4,49	12,00	3,40	3,53	12,00	4,20	2,86	12,00	4,95	2,42	12,00	5,77	2,08
7	12,00	2,00	6,00	12,00	2,50	4,80	12,00	3,24	3,70	12,00	3,94	3,05	12,00	4,52	2,65
25	12,00	1,20	10,00	12,00	1,49	8,05	12,00	2,10	5,71	12,00	2,75	4,36	12,00	3,11	3,86

WH-MXC16J9E8

Tamb	HC	IP	COP	HC	IP	COP	HC	IP	COP	HC	IP	COP	HC	IP	COP
LWC	25	25	25	35	35	35	45	45	45	55	55	55	60	60	60
-20	16,00	7,40	2,16	16,00	8,40	1,90	16,00	10,00	1,60	14,00	10,30	1,36	—	—	—
-15	15,30	6,10	2,51	16,00	6,91	2,32	16,00	8,44	1,90	16,00	9,97	1,60	14,00	10,60	1,32
-7	19,00	6,60	2,88	16,00	6,70	2,39	16,00	7,85	2,04	16,00	9,33	1,71	15,00	9,70	1,55
2	20,60	5,35	3,85	16,00	5,16	3,10	16,00	6,40	2,50	16,00	7,72	2,07	16,00	9,20	1,74
7	16,00	2,80	5,71	16,00	3,54	4,52	16,00	4,55	3,52	16,00	5,60	2,86	15,60	6,50	2,40
25	16,00	1,55	10,32	16,00	2,30	6,96	16,00	3,20	5,00	16,00	4,00	4,00	15,50	4,50	3,44

Aquarea T-CAP Mono-bloc J Generation Single phase / Three phase. Heating and Cooling - MXC · R32

Outdoor		WH-MXC09J3E5									WH-MXC12J6E5																	
Tamb	CC	IP	EER	CC	IP	EER	CC	IP	EER	CC	IP	EER	CC	IP	EER	CC	IP	EER										
LWC	7	7	7	14	14	14	18	18	18	7	7	7	14	14	14	18	18	18										
16	9,00	1,61	5,59	11,00	1,49	7,38	11,40	1,30	8,77	11,40	2,10	5,43	13,60	2,09	6,51	15,00	2,06	7,28										
25	9,00	2,00	4,50	12,60	2,38	5,29	10,50	1,54	6,82	12,00	2,87	4,18	15,70	3,60	4,36	14,00	2,56	5,47										
35	9,00	2,83	3,18	10,90	2,98	3,66	9,00	1,95	4,62	12,00	4,14	2,90	13,60	4,35	3,13	12,00	3,04	3,95										
43	7,20	3,26	2,21	8,70	3,23	2,69	7,30	2,43	3,00	10,30	4,89	2,11	11,80	4,98	2,37	10,40	3,72	2,80										
Outdoor		WH-MXC09J3E8									WH-MXC12J9E8									WH-MXC16J9E8								
Tamb	CC	IP	EER	CC	IP	EER	CC	IP	EER	CC	IP	EER	CC	IP	EER	CC	IP	EER	CC	IP	EER	CC	IP	EER				
LWC	7	7	7	14	14	14	18	18	18	7	7	7	14	14	14	18	18	18	7	7	7	14	14	14	18	18	18	
16	9,00	1,66	5,42	11,00	1,54	7,14	11,40	1,35	8,44	11,40	2,15	5,30	13,60	2,14	6,36	15,00	2,15	6,98	15,00	3,15	4,76	19,00	3,35	5,67	19,00	3,00	6,33	
25	9,00	2,06	4,37	12,60	2,45	5,14	10,50	1,60	6,56	12,00	2,93	4,10	15,70	3,68	4,27	14,00	2,66	5,26	15,00	4,00	3,75	18,00	4,00	4,50	18,00	3,50	5,14	
35	9,00	2,91	3,09	10,90	3,07	3,55	9,00	2,02	4,46	12,00	4,23	2,84	13,60	4,44	3,06	12,00	3,17	3,79	14,50	5,11	2,84	14,50	4,20	3,45	16,00	4,27	3,75	
43	7,20	3,36	2,14	8,70	3,33	2,61	7,30	2,53	2,89	10,30	5,00	2,06	11,80	5,09	2,32	10,40	3,87	2,69	9,50	4,40	2,16	11,50	4,40	2,61	12,50	4,30	2,91	

Tamb: Ambient Temperature [°C]. LWC: Leaving Water Condenser Temperature [°C]. HC: Heating Capacity (kW). CC: Cooling Capacity (kW). IP: Input Power (kW). This data is measured by Panasonic in accordance with EN14511-2 standard. This data is for reference purpose only, and does not guarantee the performance.

Examples of installations

**Aquarea H and J Generations:
Bivalent with buffer tank and mixing valve**

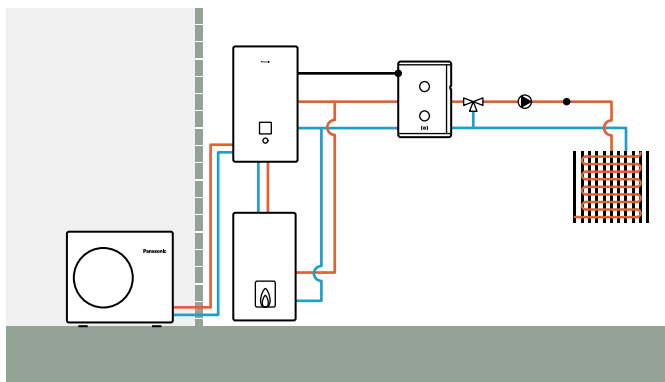

**Aquarea H and J Generations:
Buffer tank with solar and mixing valve**

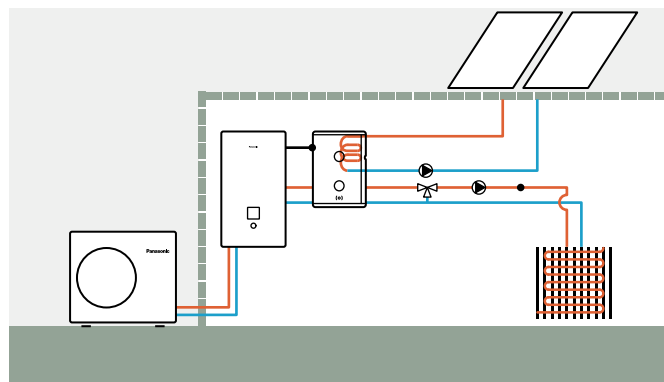

**Aquarea H and J Generations:
2 zones with external kit without buffer tank**

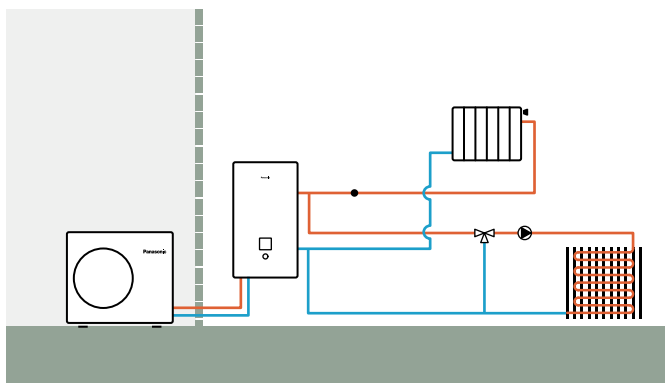

**Aquarea H and J Generations:
2 zones with external kit, buffer tank and swimming pool**

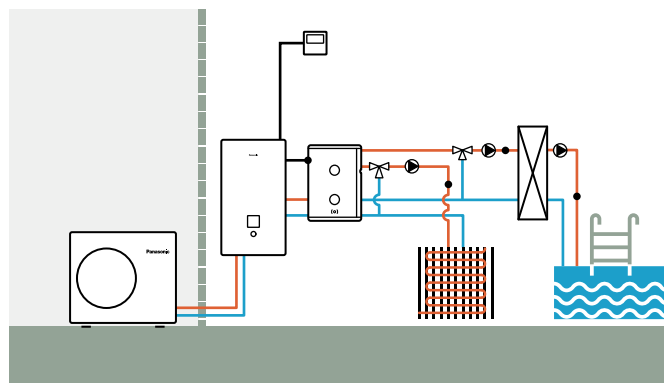

**Aquarea All in One H and J Generations:
2 zones with external kit, without buffer tank**

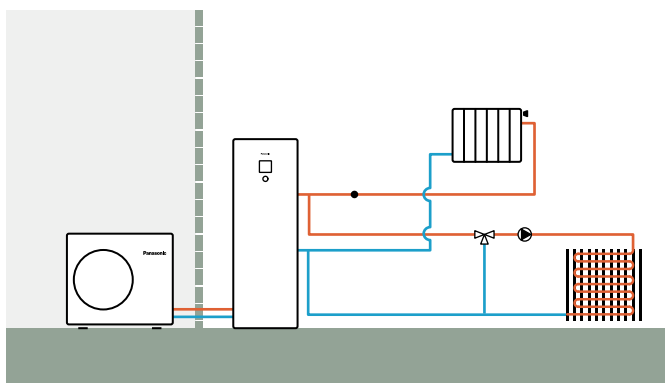

**Aquarea All in One 2 zones H and J Generations:
2 zones built-in, without buffer tank**

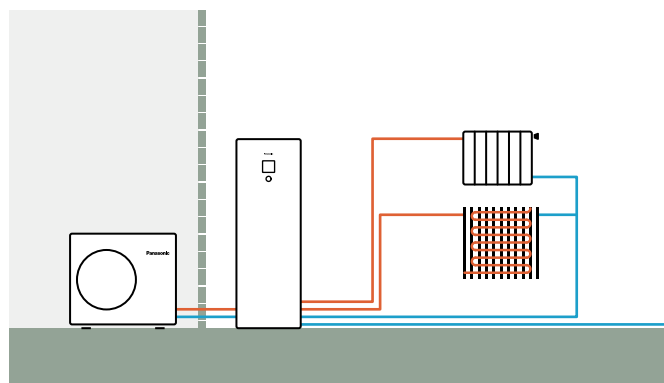

Due to the ongoing innovation of our products, the specifications of this catalogue are valid barring typographic errors, and may be subject to minor modifications by the manufacturer without prior warning in order to improve the product. The total or partial reproduction of this catalogue is prohibited without the express authorisation of Panasonic Marketing Europe GmbH.

Panasonic®

To find out how Panasonic cares for you, log on to:
www.panasonic.co.uk/aircon

General requests:
Email: uk-aircon@eu.panasonic.com

Sales administration team:
Email: uk-aircon-salesadmin@eu.panasonic.com

Technical service team:
Email: uk-aircon-tech@eu.panasonic.com
UK Office : +44 (0) 1707 378670

Panasonic Heating & Ventilation Air-Conditioning UK Ltd.
Registered Office: Ground Floor, Building 3, Albany Place, Hyde Way, Welwyn
Garden City, Hertfordshire AL7 3BT
Company Registration: 02371708



Do not add or replace refrigerant other than the specified type. Manufacturer is not responsible for the damage and deterioration in safety due to usage of the other refrigerant.
The outdoor units in this catalogue contains fluorinated greenhouse gases with a GWP higher than 150.

