

## ROOFING PRODUCTS

Vents, terminals, adaptors  
& accessories



# Contents

Ventilation Regulations	3
UB19 Ubivent Tile/Slate Vent	4
UB8 Plain Tile Vent	5
UB62 In-line Tile Vent	6
UB16 Universal Tile Vent	7
UB11 Vepac Slate Vent	8
UB17 Slate Space Vent	9
OFVS Over Fascia Vent System	10
DOS10/25 Fascia Vent	12
Eaves Guard	13
BCF55 Bird Comb Filler	14
Sim-Fix® Slate Strap	15
RB100 Roll Out Rafter Tray	16
Flexible Dry Ridge Kit and Hip Accessories	17
Universal Dry Verge System	18
UB34/35 Multivent Terminal	19
UB46/47/48 Universal Insulated Terminal	20
UB41 Universal Service Terminal	21
UB37 Plain Tile Terminal	22
UB39 Vepac Terminal	23
Ventus & Valetis Roof Terminals	24
Adaptors, Connectors & Pipes	26
Flat Roof Vent/Terminal	29
Solar - Air Conditioning Cable & Pipe Terminal - Pitched Roof	32
Solar - Air Conditioning Cable & Pipe Terminal - Flat Roof	33
Solar - Bird & Rodent Protection	34

## Cold Roof Void

Pitched Roof over 15°

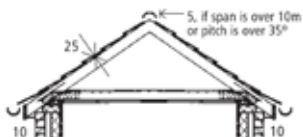

## Cold Roof Void

Mono Pitched Roof over 15°

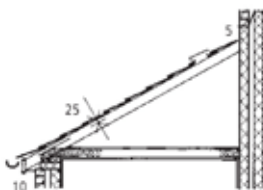

## Warm Roof Void

(non convection tight)

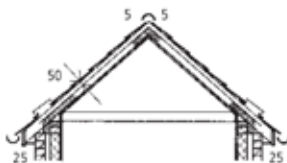

## Warm Roof Void

Roof window or other obstruction  
in a fully inclined ceiling

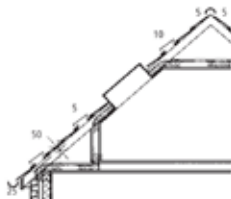

# » VENTILATION REGULATIONS «

## Pitched Roofs

Building Regulation C2, Roofs (Resistance to damage from interstitial condensation) 6.10 - A roof will meet the requirement if it is designed and constructed in accordance with clause 8.4 of BS5250, BS5534 and EN ISO 13788. These and other situations are shown in the diagrams opposite. Tiled or slated pitched roof slopes of 15° and above should be provided with ventilation openings equivalent to the following continuous openings:

### Cold Roof

Low level ventilation to two opposite sides - 10mm

High level ventilation to two opposite sides for pitches over 35° and spans over 10m - 5mm

### Warm Roof (non-convection tight)

Low level ventilation to two opposite sides - 25mm

High level ventilation to two opposite sides - 5mm

### Lean-to & Mono-pitched roofs

Low level ventilation cold roof - 10mm

Non-convection tight warm roof - 25mm

High level ventilation - 5mm

For roofs incorporating type LR underlays please refer to BS5250.

### Slope vents

Guide to positioning of slope vents

Code	Free Vent Area mm <sup>2</sup>	Spacing of vents (m) equivalent to continuous opening		
		5mm	10mm	25mm
UB19	22,000	4.400	2.200	0.880
UB8	6,250	1.250	0.625	0.250
UB11	10,750	2.150	1.075	0.430
UB16	18,750	3.750	1.800	0.750
UB17	10,000	2.000	1.000	0.400
UB62	15,000	3.000	1.500	0.600

# UB19 Ubivent Tile/Slate Vent



## Design & Performance

The UB19 is a streamlined hood suitable for most roof finishes and has a free vent area of 22,000mm<sup>2</sup>. This unit allows less vents to be used to meet British Standards due to the higher free vent area. UB19's are suitable for roofs pitches from 17.5–55° for tile and 23.5–55° for slate. For the UB19 to be converted into a terminal for soil & vent, mechanical & natural ventilation. See page 26.

## Material

Polypropylene

## Colour

Profile	Red	Terracotta	Anthracite	Sepia
Modern (MD/MDA)	•		•	•
Mendip (MEN)	•		•	•
Ludlow Major (MLM)	•		•	•
Ludlow Plus/49 (GSA)	•		•	•
Double Roman (FRA)	•	•	•	•
Wessex (WS)			•	•
Stonewold (SWA)			•	•
Regent (NER)			•	•
Renown (RS)			•	•
Mini Stonewold (MST)			•	
Caledonian (CD)			•	•
Delta (DS)			•	•
Centurian (ACT)			•	
Marley Bold Roll (MBR)			•	
Norfolk Pantile (RE)			•	
Slate 500x250mm (NJ)			•	
Slate 600x300mm (NS)			•	
Slate 600x450mm (NL)			•	
Plain Tile 500x640mm (PTU)			•	•

# UB8 Plain Tile Vent



## Design & Performance

The UB8 is an in-line roof ventilating tile for use in small plain non-interlocking tiles. Designed specially to merge into the surface of plain tiles without disturbing the roofline, each UB8 has a free vent area of 6,250mm<sup>2</sup> and is suitable for roof pitches from 35–55°. The design features a slotted insect inhibitor to keep out large insects and vermin. UB8 plain tile vents are suitable for both high and low level ventilation and can be installed without batten or tile trimming.

The standard UB8 has matching units also available for the termination of building services by adding a UB8 connector (294304) (soil & vent, mechanical and natural ventilation) – see UB37 Plain Tile Terminal on page 22.

The UB8 clay slip unit has the same technical data as the standard UB8, but allows you to apply your own cut tiles to give colour matching.

## Material

Polypropylene

## Colour (UB8's only)

Standard colours: Red, Terracotta, Anthracite, Sepia

# UB62 In-line Tile Vent

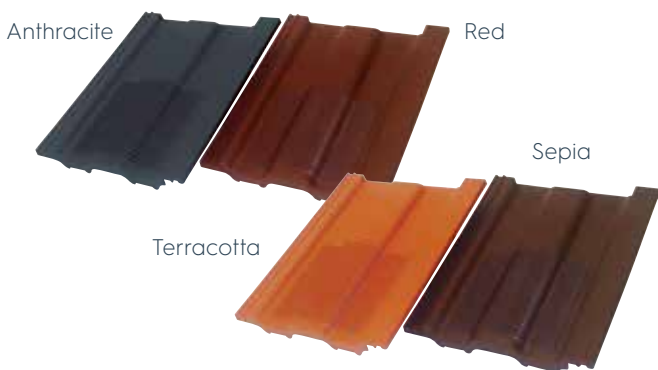

## Design & Performance

The UB62 in-line tile vent offers high performance whilst retaining the aesthetics of the roof design. It is designed to provide ventilation of the roof space, either at high or low levels.

UB62s are suitable for pitches from 25-55° and may be used to supplement or replace other ventilation such as dry ridge, abutment or eaves systems. They are also suitable for ventilation of compartmental roof spaces, such as fire walls.

With the use of a stepped adaptor, the UB62 can also be used for mechanical extraction or with soil pipes for removal of stale air, as well as bathroom fans to small kitchen extracts.

The UB62 provides up to 15,000mm<sup>2</sup> of free vent area, and has a large insect and vermin grille.

## Material

Polypropylene

## Colour

Standard colours: Red, Terracotta, Anthracite, Sepia

Profile	Red	Terracotta	Anthracite	Sepia
Modern (MD/MDA)	•	•	•	•
Ludlow Major (MLM)		•	•	•
Double Roman (FRA)	•	•	•	•
Double Pantile (MEN)	•	•	•	•
Ludlow Plus/49's (GSA)	•	•	•	•

# UB16 Universal Tile Vent



## Design & Performance

The UB16 is a universal roof vent for use in most tiled and slated pitched roofs without the need to identify the make or design of the tiles or slates.

The unit comprises a streamlined hood on a circular upstand with a 500mm x 500mm Ubiflex flashing skirt. The upstand protrudes below the Ubiflex skirt to form a 160mm diameter penetration sleeve. The free vent area of the UB16 is 18,750mm<sup>2</sup> from pitches 20–55° and it has an integral mesh to stop the ingress of large insects and vermin.

If a matching terminal is required the UB41 should be used – see page 21.

## Material

Ubiflex skirt around PVC-u upstand with streamlined hood

## Colour

Hood: Red, Terracotta, Anthracite, Sepia

Red hood & Terracotta hood = Terracotta Ubiflex

Anthracite hood & Sepia hood = Black Ubiflex

# UB11 Vepac Slate Vent

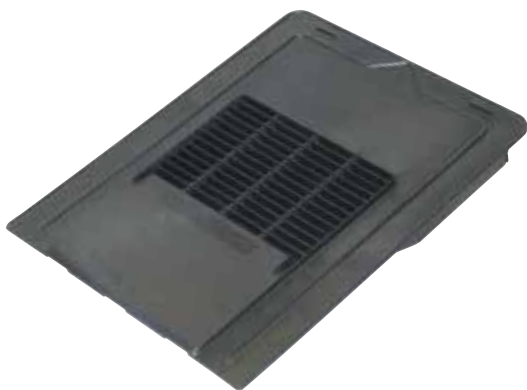

## **Design & Performance**

The UB11 Vepac vent is an in-line unit with a multi-purpose base which will provide inconspicuous ventilation in natural and man-made slate roofs (suitable for 600mm x 300mm and 500mm x 250mm). Ubbink now also offer a larger unit which is only suitable for 600mm x 300mm slates.

UB11s are suitable for high or low level ventilation in roofs of 25° and over. Each vent has a slotted inhibitor to keep out large insects and vermin and provides a free vent area of 10,750mm<sup>2</sup>.

This vent can be adapted for use as a service terminal with a vepac connector and lower pipe – see UB39 on page 23.

## **Material**

Polypropylene/Copolymer

## **Colour**

Anthracite



# UB17 Slate Space Vent



## **Design & Performance**

The UB17 Slate Space Vent is a roof void ventilator for use in slates.

The base is supplied as a direct replacement for a 600mm x 300mm slate. When the 25mm side bands are trimmed off and the inner set of fixing points are used, the unit is then a direct replacement for a 500mm x 250mm slate. It also comes complete with a disc rivet hole and is suitable for pitches from 23–55°.

The UB17 is suitable for both high and low level ventilation and has a free vent area of 10,000mm<sup>2</sup>.

The vent can be adapted for use as a service terminal with a UB17 adaptor. See page 27.

## **Material**

Polyethylene

## **Colour**

Black

# OFVS Over Fascia Vent System



## Design & Performance

The Ubbink Over Fascia Vent System is a one-piece interlocking system fitted to the top of the fascia which provides:

- Eaves level continuous ventilation
- Semi-rigid hinged underlay support flap
- Large insect and vermin inhibitor
- Discharge of water from underlay to gutter
- Under tile bird excluder (OFVS10 only)

There are two types of OFVS system available which are suitable for use in roof pitches 15° - 70° although below 23° additional support may be needed for the support flap to prevent ponding.

OFVS10 & OFVS10L provide 900mm length x 10mm continuous ventilation.

The interlocked strips are nailed to the top of the fascia and nail fixings should be calculated in accordance with BS5534.

The fixing points are designed to eliminate any water leakage as are the interlocks between strips.

It should be noted that some cellular PVC-u fascia boards cannot take vertical fixings. In such cases the system may be fixed through its underlay support into a batten fixed to the rafters behind the fascia board. However, space must be left between the back of the fascia board and the fixing batten to allow air to pass into the roof void.

In full boarded roofs, a section of boarding immediately behind the fascia should be removed to allow air to pass into the roof void.

# OFVS Over Fascia Vent System (continued)

At hips and valleys, the system should be sawn to form tight fitting mitred joints. To prevent possible leakage at valleys, a flashing of underlay material should be positioned under the joint to discharge into the gutter.

In a parapet/valley gutter situation in the absence of a fascia, it may be possible to introduce a timber fillet on which the system can be fixed.

When installing OFVS, due allowance must be made for the height of the system. The following figures can be used as guidelines:

Pitch of Roof Allowance	OFVS10 & OFVS10L
15-50°	20mm
51-55°	25mm
56-60°	30mm
61-65°	35mm
66-70°	40mm

## Material

Polypropylene

## Colour

Black

# DOS10/25 Fascia Vent



## **Design & Performance**

DOS10/25 is an over fascia vent strip. It is designed with a radiused leading edge to protect the felt and has an integral large insect and vermin inhibitor.

DOS10 is 28mm high x 35mm deep x 1.0m. The strips lock together and provide 10,000mm<sup>2</sup> per metre of continuous ventilation.

DOS25 is 32mm high x 35mm deep x 1.0m. The strips lock together and provide 25,000mm<sup>2</sup> per metre of continuous ventilation.

## **Material**

Polypropylene

## **Colour**

Black

# Eaves Guard

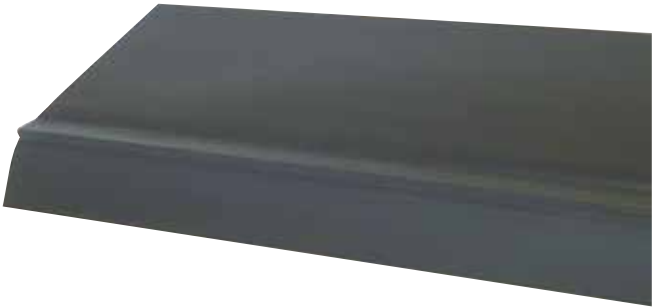

## Design & Performance

The Ubbink Eaves Guard is designed for use in both refurbishment projects and new build to provide an effective level of eaves protection.

Available in 1.5m lengths, the rigid pre-formed strips are suitable for use in roof pitches of 15–70°. On existing buildings, Eaves Guard can be used to replace rotted gutter felt with the minimum of disruption to the existing slate or tile roof covering.

In new build situations, the preformed Eaves Guard strip directs water away from the underlay and into the gutter. At the same time it provides an effective underlay support flap, preventing ponding of the underlay behind the fascia board. Eaves Guard is ideal for use with the new generation of lightweight, high performance underlays, which are not suitable for forming a drip into the gutter.

Eaves Guard is fixed to the top of the fascia with clout nails. If a plastic fascia is used which will not support clout nails, Eaves Guard may be fixed to a batten behind the fascia.

## Material

PVC-U

## Colour

Black

# BCF55 Bird Comb Filler



## **Design & Performance**

The Ubbink Bird Comb Filler prevents the ingress of birds between the underside of profiled tiles and the underlay on pitched roofs.

Manufactured in 1.0m strips, it is predrilled ready to fix to the top of the fascia and the teeth of the comb prevent birds from entering and nesting in the spaces under tile profiles.

## **Material**

Rigid polypropylene

## **Colour**

Black

# Sim-Fix® Slate Strap



## Design & Performance

Quick and easy to use, the Sim-Fix® is designed to re-fix all sizes of slates which have slipped from their original position. As well as securing against slippage it also secures against wind uplift. With its unique ratcheted retaining clip Sim-Fix® can be used with all common slates. It is manufactured to blend in with the roof once fixed into position.

## Material

Made from durable weather and pollution resistant nylon.

## Colour

Black

# RB100 Roll Out Rafter Tray



## **Design & Performance**

RB100 Roll Out Insulation Rafter Tray provides a minimum 25mm clear airway between the ceiling insulation and the roof underlay and is suitable for use in cold roofs, but not suitable for warm roof voids. It is used in conjunction with eaves ventilation products.

Each Roll is 6m long and available in 300mm, 400mm, 600mm, 800mm, 900mm, 1000mm and 1200mm widths.

## **Material**

PVC-u

## **Colour**

Black



# Flexible Dry Ridge Kit



**BS8612  
Compliant**  
as tested  
by the BRE

## Design & Performance

The Ubbink Flexible Dry Ridge Kit is a mortar free system to mechanically fix the ridge tiles according to BS5534. It is easy to install under most weather conditions and the kit offers enough components for a typical ridge of up to 6m. The kit provides high level ventilation, is watertight and has a wind uplift to suit most UK properties.

This is a truly ventilating ridge kit for flat interlocking, slate and plain tile as well as profiled tiles.

It matches a comprehensive range of ridge tiles, including:

- Redland Universal Angle
- Half Round/Segmental
- Marley Modern

## Dry Ridge Kit components:

- 13 ridge unions
- 26 ridge clips
- 13 clamping plates
- 13 waterproof screws
- 1 ridge roll (6m x 300mm)
- 10 ridge batten straps
- Installation guide

Hip trays are available in Black 1200mm long and are quick and easy to install. There is no need for mortar when installing and can be installed in most weather conditions. The trays are suitable to be used with slates, concrete flat and profile tiles.

## Hip accessories:

- Hip Trays 1200mm
- Short tile clips
- Long tile clips

# Universal Dry Verge System

**BS8612**  
**Compliant**  
as tested  
by the BRE



## Design & Performance

The Universal Dry Verge is a mortar free system to mechanically fix the verge tiles according to BS5534 and meets all NHBC Regulations giving a 10 year warranty. The ambi units have a water channel built in to prevent water staining, often a common issue with other dry verge systems.

With a batten gauge of 255mm to 355mm the system suits most popular profile tiles including the thin leading edge tile. Included in the system is a batten bracket, which gives a secure fixing to the end of the cut flush batten ensuring there is a straight/equal install line for the verge.

The system suits roof pitches up to 55° and is easy and quick to install. It offers integral solutions for a secure fixing to the roof. The unique starter unit at the eaves offers three different installation options: fixing to the barge board; to the fascia board; or to the lowest batten. It can also be installed with or without the gutter in place.

## Dry Verge System Components

- Ambi verge units
- Half round/segmental or universal angled ridge end cap
- Starter unit (incorporates closure)
- Batten bracket

## Material

Ambi verge units and Ridge End Caps; PP Talc, UV resistant  
Brackets and Starter Units; PP Talc

## Colours

Grey, Brown, Terracotta

# UB34/35 Multivent Terminal



## Design & Performance

Specially designed for systems requiring a low resistance terminal, the Multivent Service Terminals are suitable for mechanical and natural (passive) ventilation installations. The pipework above the roofline is twin walled and incorporates an integral condensation drain. Two models are available, the UB34 with an internal diameter of 125mm and the UB35 with an internal diameter of 160mm and suitable for tiled and slated pitched roofs.

The unit is suitable for roof pitches of 25–45° and comes complete with flashing – a universal base for both tiles and slates (UB35 160mm dia). Special lower and higher pitch versions are available to order.

The free vent areas of the units are:

125mm dia = 12,250mm<sup>2</sup>

160mm dia = 18,750mm<sup>2</sup>

The pressure airflow resistance of both units is <1.0 Pascal at 225m<sup>3</sup>/h.

## Material

Stack and cowl: polyethylene

Tiled & slate flashing: polyethylene & Ubiflex non-lead flashing

## Colour

Black

# UB46/47/48/49 Universal Insulated Terminal



UB46,47 & 49

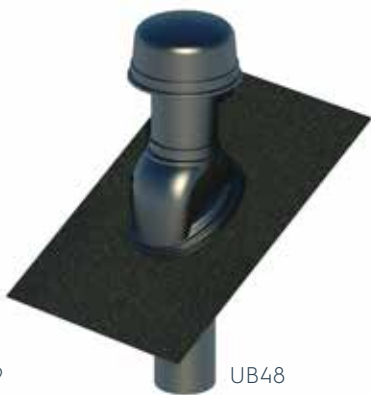

UB48

## Design & Performance

Insulating ducts in air distribution systems used for ventilation, heating or cooling is often required to minimise heat loss or prevent condensation on or in the duct. Ubbink has developed a complete range of insulated terminals, which are extremely easy to install and maintain. · They can be used for tiles and slates · Insulated through the cowl.

There is a risk of condensation in or on ductwork if the air in the duct is colder than the ambient air (or vice versa). Therefore, it is very important to use insulated ductwork if such conditions could occur.

All 3 models are suitable for tiles and slates with 25° to 45° pitch.

The free vent areas and diameters of the units are:

UB46 125mm dia = 12,250mm<sup>2</sup>

UB47 150mm dia = 17,750mm<sup>2</sup>

UB48 180mm dia = 19,100mm<sup>2</sup>

UB49 160mm dia = 18,750mm<sup>2</sup>

The pressure airflow resistance of all units is <1.0 Pascal at 225m<sup>3</sup>/h.

## Material

Injection moulded/Vacuum formed/Ubiflex

## Colour

Black

Please Note: The UB46,47,48 & 49 are all supplied in a larger diameter stack but each box includes the relevant reducer to connect to the required diameter.

# UB41 Universal Service Terminal



## Design & Performance

The UB41 is a Universal Service Terminal for use in most tiled and slated pitched roofs without the need to identify the make or design of the tiles or slates. The unit comprises a streamlined hood on a circular upstand, a 500mm x 500mm Ubiflex flashing skirt and stepped adaptor which allows connections from 100mm to 160mm diameter ducting. The unit may also be used to terminate soil & vent pipes where an external pressure test is not required. The free vent areas and pressure/airflow resistance readings for the UB41 are as follows:

Diameter (mm)	Free Vent Area (mm <sup>2</sup> )	Pressure/Airflow resistance (Pascals)	
		100m <sup>3</sup> /h	225m <sup>3</sup> /h
100	7,850	7.5	7.5
110	8,850	4.5	16.0
125	12,250	5.3	24.0
150	17,750	6.5	31.0
160	18,750	6.5	31.0

The unit is easy to install - the adaptor is cut off at the required diameter and attached to the undertile spigot with solvent weld/PVC glue. The Ubiflex flashing allows fitting into most tiles/slates.

## Material

Ubiflex skirt around PVC-u upstand with streamlined hood together with a stepped adaptor

## Colour

Hood: Red, Terracotta, Anthracite, Sepia

Red hood & Terracotta hood = Terracotta Ubiflex

Anthracite hood & Sepia hood = Black Ubiflex

# UB37 Plain Tile Terminal



## Design & Performance

The Ubbink Plain Tile Terminal is an in-line pitched roof terminal for use in small plain non- Interlocking tiles. It is suitable for terminating 110mm diameter mechanical extract systems and soil & vent systems where an external pressure test is not required.

For aesthetic purposes, the UB37 terminal matches the UB8 roof ventilating tile (please see page 5).

The UB37 has a free vent area of 6,250mm<sup>2</sup> and a pressure/airflow resistance reading of 11Pa at 100m<sup>3</sup>/h.

## Material

Unit: Polypropylene

Adaptor: Styrosun® 3600 UV Resistant High Impact Polystyrene

## Colour

Red, Terracotta, Anthracite, Sepia

# UB39 Vepac Terminal



## **Design & Performance**

The Ubbink Vepac Terminal is an in-line service terminal for use in slated roofs in pitches of 25–55°.

The UB39 is suitable for terminating 110mm diameter mechanical extract systems and soil & vent systems where an external pressure test is not required. As the insect grille has been removed for adaptor fitting, this product cannot be used as a pitched roof void vent. The adaptor has to be fitted before installation of the roof.

For aesthetic purposes, the UB39 terminal matches the UB11 roof ventilating slate (please see page 8).

The UB39 has a free vent area of 7,800mm<sup>2</sup> and a pressure/airflow resistance reading of 19.0 Pascals (reading taken at 100m<sup>3</sup>/h).

## **Material**

Slate vent and adaptor: Polypropylene Copolymer

Pipe: Polyethylene

## **Colour**

Anthracite

# Ventus - Insulated Roof Terminal



Flat roof solution



Pitched roof solution with perpendicular roof penetration

## Design & Performance

The Ventus is a new generation of clever insulated roof terminals developed for heat recovery ventilation systems for residential and small commercial buildings. It comes in one colour and in four installation kits for either a range of pitched or flat roof applications. Excellent performance on pressure loss comes standard and contributes to a higher ventilation efficiency and lower energy consumption.

Suitable for a wide range of pitched roof applications (15- 55°) with integrated tile base, designed to fit to Aerfoam 160 mm & 200 mm (adaptors to fit to 150 mm and 180 mm).

## Material

Terminal: PP

Insulation: EPS

Insulated ductwork: EPE (Aerfoam)

Pitched roof tile: PP, PA & Ubiflex lead-free flashing

Flat roof tile: Aluminium.

## Colour

Black



# Valetis Roof Terminal



Grey/Black



Terracotta



Red



Brown

## Design & Performance

The Valetis represents the new generation of smart roof terminals, designed with a sleek aesthetic, and optimised for the termination of ventilation system C. Available in various colours, it delivers excellent pressure loss performance. This enhances ventilation efficiency and reduces energy consumption, resulting in cost savings for homeowners.

Easy installation thanks to the angled roof terminal ensuring maximum roof insulation values are maintained. Low installation height: the penetration conforms to the roof's shape and extends only 140 mm above it. For roof pitches 15-55°

## Material

Roof terminal: PP

Roof tile: Ubiflex Standard

## Colour

Standard colours: Red, Terracotta, Anthracite, Sepia

# Adaptors, Connectors & Pipes



## UB19 Felt Sleeve & Adaptor

These adaptors allow the on-site conversion of UB19 Tile/Slate vents to service terminals.

The felt sleeve click-fits in place into the underside of the UB19. The stepped adaptor is cut off at the required diameter and then pushed onto the sleeve. The joint between the felt sleeve and adaptor should be sealed with PVC solvent weld.

### UB19 with Felt Sleeve & Adaptor

Diameter (mm)	Free Vent Area (mm <sup>2</sup> )	Pressure Airflow Resistance (Pascals)	
		100m <sup>3</sup> /h	200m <sup>3</sup> /h
110	8,850	3.2	12.8
125	12,250	4.5	18.0
150	17,775	5.8	23.0
160	18,750	6.0	24.2

### Material

Styrosun® 3600 UV Resistant High Impact Polystyrene

## Adaptors, Connectors & Pipes (continued)



### UB17 Connector & Lower Pipe

Adaptor to convert a UB17 Space Slate Vent into a service terminal with a 110mm diameter spigot.

**Material**

Polypropylene



### UB11 and Vepac Connector & Lower Pipe

The UB11 and Vepac Connector & Lower Pipe convert the UB11 vent to the UB39 terminal with a spigot diameter of 110mm.

**Material**

Polypropylene

## Adaptors, Connectors & Pipes (continued)



### Connector for UB8

UB8 connector converts the vent into a UB37 terminal with a 110mm diameter spigot.

**Material**

Styrosun® 3600 UV Resistant High Impact Polystyrene



### Flexible Pipes and Seals (FPJs)

The FPJs110/110 is a 600mm black polyethylene moulded flexible pipe which connects soil and vent pipe terminals to the systems allowing for an offset of up to 200mm. The units come complete with sealing rings.

# Flat Roof Vent/Terminals

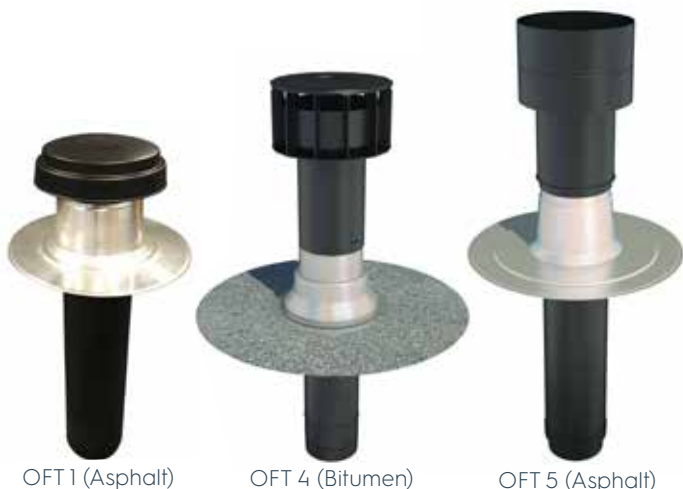

## Design & Performance

The Ubbink OFT range vents are capped stacks for use in flat roofs with the following roof finishes:

- Asphalt
- Built up felt
- EPDM
- Bitumen
- GRP roofs

The OFT/1 and OFT/4 are suitable for use with soil & vent systems and for both mechanical and natural (passive) ventilation installations (available in all materials).

The OFT/2 is a 100mm/160mm diameter void vent.

The OFT/4 has a special low air resistance cowl – the pressure/airflow resistance is <1.0 Pascal at 225m<sup>3</sup>/h (available in all materials). The pipework above the roofline is twin walled and incorporates an integral condensation drain. The stack pipe has an integral collar and separate flashings to match the above mentioned materials. It should not be installed in extreme areas due to the openness of the cowl.

OFT range information continued on next page >

# Flat Roof Vent/Terminal (continued)

The OFT 5 insulated terminal range is suitable for use with heat recovery and high volume extract fans and for both mechanical and natural (passive) ventilation installations. It has a higher insulation value above the roof space which reduces the risk of condensation. The OFT 5 internal spigot is always 166mm (excluding OFT 5 180 mm) with additional reducers provided.

- The external height of all OFT's cannot be reduced
- The internal spigot length can be reduced to suit the installation needs
- The ducting that is used must be the same diameter as the spigot from the extract fan all the way through the terminal
- In a cold roof void all ducting must be insulated to reduce condensation risk

## Product Specification

Code	Dia.	Height above roof	Flange dia.	Depth below flange	Free vent area	Pressure/ airflow resistance	Minimum hole in Roof size
	mm	mm	mm	mm	mm <sup>2</sup>	Pa	mm
OFT/1A	110	220	330	600	8,400	5.9	110
	160	240	363	600	18,750	3.0	160
OFT/1	131	500	450	350	12,000	1.1	131
	166	522	450	350	18,750	1.0	166
OFT/2	110	220	330	10	8,400		110
	160	240	363	10	18,750		160
OFT/4	110	465	395	350	8,400	<1.0	131
	131	465	450	350	12,000	<1.0	131
	166	510	450	510	18,750	<1.0	166
OFT/5	125	522	490	608	11,300	5.3	166
	150	522	490	608	14,400	1.3	166
	180	560	495	699	19,100	1.3	186

\*Readings for OFT/1F &OFT/1A at 100m<sup>3</sup>/h. Readings for OFT/4 at 225m<sup>3</sup>/h. Readings for OFT/5 at 200m<sup>3</sup>/h.

# Flat Roof Vent/Terminal (continued)

## Product Performance (pitched roof terminals)

Air Flow m <sup>3</sup> /h					
		100	200	400	800
<b>UB19 with F.S &amp; A</b>	110mm (Pa)	3.2	12.8	51.2	204.8
	125mm (Pa)	4.5	18	72	288
	150mm (Pa)	5.8	23	92	368
	160mm (Pa)	6	24.2	96.8	387.2
<b>UB41</b>	110mm (Pa)	3	12	48	192
	110mm (Pa)	4.5	18	72	288
	125mm (Pa)	5.3	21.2	84.8	339.2
	150mm (Pa)	6.5	26	104	416
	160mm (Pa)	6.5	26	104	416
<b>UB62 With F.S (Pa)</b>		29.4	117.6	470.4	1881.6
		112	225	450	900
<b>UB34 125mm (Pa)</b>		<1	<1	4	16
<b>UB35 (Pa)</b>		<1	<1	4	16

## Product Performance (flat roof terminals)

Air Flow m <sup>3</sup> /h					
		100	200	400	800
<b>OFT1</b>	110mm (Pa)	5.9	23.6	94.4	377.6
	131mm (Pa)	1.1	4.4	17.6	70.4
	160mm (Pa)	3	12	48	192
	166mm (Pa)	1	4	16	74
		<b>112</b>	<b>225</b>	<b>450</b>	<b>900</b>
<b>OFT4</b>	110mm (Pa)	<1	<1	4	16
	125mm (Pa)	<1	<1	4	16
	150mm (Pa)	<1	<1	4	16
	160mm (Pa)	<1	<1	4	16
		<b>100</b>	<b>200</b>	<b>400</b>	<b>800</b>
<b>OFT5</b>	125mm (Pa)	2.56	5.3	21.2	84.8
	150mm (Pa)	<1	1.3	5.2	20.8
	180mm (Pa)	<1	1.3	5.2	20.8

# Solar - Air Conditioning Cable & Pipe Terminal: Pitched Roof

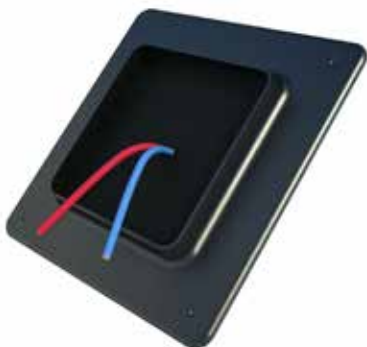

## Design & Performance

The cable entry tile for solar panels is UV resistant and suitable for most types of roofs, 15 - 55°. It allows the passage of up to 6 cables with a diameter ranging from 4 to 8 mm. Since the cables do not have to be passed between the tiles, there is no risk of tile breakage or cable wear over time. The Ubiflex skirt guarantees the tightness of the cable entry and perfectly matches the shape of the tile.

## Material

Cable cover: High density polyethylene (HDPE)

Skirt: Ubiflex Standard

## Colour

Black



# Solar - Air Conditioning Cable & Pipe Terminal: Flat Roof



## Design & Performance

The Ubbink Solar-Air Conditioning cable and pipe transit range provides versatile solutions for safely and easily routing the cables of PV panels, air conditioning systems, and solar thermal pipes on flat roofs. These transits are designed to ensure maximum safety and security, offering universal compatibility with brand-independent systems. They are practical and quick to install on flat roofs, delivering durable, long-lasting performance for various applications.

## Material

Cap: Plastic

Base: Aluminium

## Colour

Cap: black

Flange: Natural

# Solar - Bird & Rodent Protection



## Design & Performance

Birds and rodents can cause damage to the roof and solar panels with an on roof installation. In addition, good ventilation under the solar panels is very important for the operation and lifespan of the solar panels. The Solar Bird protection and 90° angle offer the solution here! You can mount the Solar Bird Protection easily and quickly on almost all common types of solar panels.

## Material

PP

## Colour

Black





ENERGY



VENTILATION



BUILDING



**Ubbink (UK) Ltd**

@ sales@ubbink.co.uk •  www.ubbink.com

Copyright © 2024 Ubbink | Content is subject to change without notice;  
no liability for errors and misprints | Availability and configurations may differ  
per country | UB-2024-12-V01-INT-EN