

ENERGY RECUPERATION



FREETIME[®]

3500

Self-regulating dual flow air handling unit with rotating heat exchanger, very high efficiency (>80%), high recovery efficiency, compact. Econologic[®] solution
Flow rate 100 to 3,500 m³/h





ERP2018
CALADAIRESPECT

bluetech
MADE BY CALADAIRES



APPLICATIONS

- ▲ Self-regulating ventilation and energy recovery, very high efficiency and high recovery efficiency in tertiary sector and industrial installations.
- ▲ Efficiency greater than **80 %** (EN308), compliant with **RT2012** and with the **ErP 2009/125/EC** directive.
- Air filtering, temperature control.
- ▲ One-piece unit, compact, top-mounted connectors, plug and play and interactive (except SEASON model).

RANGE

- With 6 models available, the **FREETIME®** range handles flow rates from 100 to 3,500 m³/h.

The **FREETIME®** range is available in 4 different versions:

SEASON: unit for use in temperate climate zones, intended for air circulation in buildings with energy recovery, bypass summer/winter mode, flow rate adjustable by potentiometer.

FIRST: self-regulating unit for use in temperate climate zones with active temperature management for optimal energy consumption and climatic comfort.

PREMIUM BC: As FIRST, but equipped with hot water heater for exterior temperatures down to -20°C.

PREMIUM BE: As FIRST, but equipped with electric heater for exterior temperatures down to -20°C.

CONFIGURATION

- Double-skin 10/10ths panels.
- ▲ Insulation: 25 mm high-density M0 A2-S1 mineral wool (T3 and L1 class for airtightness of the building envelope as specified by EN1886) for the 500 and 800 models, 50 mm high-density M0 A1 mineral wool (T2 and L1 class for airtightness of the building envelope as specified by EN1886) for the 1500, 2000, 2700 et 3500 sizes.
- External surface: RAL 7035 coated steel with protective film.
- Internal surface: galvanised steel.
- ▲ Circular connectors with lip joints to guarantee system airtightness (ATEC CSTB no. 13-224-12). Top-mounted connectors.
- Feet mounted in the body for handling and fixing to the floor.
- ▲ Electrical components and controls grouped in "**EASY**" technical compartment. Access via hinged opening panels for ease of maintenance. Fixed rapid-access panel on top containing lockable proximity switch, potentiometers (SEASON version) and power cable guide.
- ▲ Access to filters and internal components via hinged doors with bolts.
- Soundproof panel on ventilator fan ensures noise level is comfortable.

FANS

- ▲ Plug fans.

DOUBLE FLOW UNIT DESCRIPTION

FREETIME®

- ▲ High-efficiency, direct-drive DC motors with electronic commutation (**EC**) thermal protection and variable speed built-in. **EC** technology is an ecological® solution that guarantees low energy consumption (**RT2012**) for the management, monitoring and control of the operating point (flow adjustment between from 10 and 100%). Low noise level for improved acoustic comfort.

EXCHANGER

- High-efficiency, **variable-speed** rotating exchanger in aluminium (excluding **SEASON**). Exchanger in rigid frame, slide-mounted for ease of removal and maintenance. Rotating air exchangers - air products by Klingenburg, which is a member of the **Eurovent** certification programme for AARE units.
- ▲ Over 80% efficiency (**EN 308**).
- The exchanger's variable speed enables improved performance from the **FREETIME®** unit, particularly in mid-season.
- ▲ The exchanger includes a rotary speed detector connected to the **EASY** controller to indicate operational status (dry contact in **SEASON** version).



FILTERS

- ▲ As standard, the **FREETIME®** unit includes a high-efficiency (large filtration surface) **F7** opacimetric filter for fresh air and a G4 gravimetric filter for extracted air.
- Filters are always fitted upstream from components to ensure these are protected.
- Slide-mounted for ease of replacement.

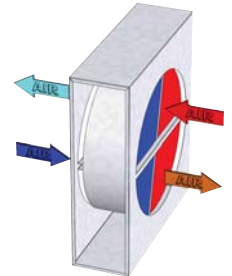

EQUIPMENT, EXTRAS AND FUNCTIONALITY

- ▲ The **FIRST** and **PREMIUM** versions are fitted as standard with an "**EASY**" controller, which can communicate via MODBUS, BACNET or WEB (protocol to be selected on site). **EASY** control is integrated into the unit and meets the requirements of our **BLUETECH®** concept, which guarantees optimal operation of the **FREETIME®** unit, complies with all French (RT2012) and European (ErP) requirements and contributes through its efficiency to active building management (EN15232). It includes a touchscreen remote control with an interface and user screen for the main functions (temperature control, restart, fault, etc.) and a maintenance interface for access to general settings (remote control from up to 100 m away).
- Internal clocks ensuring dual flow operation, which are user-programmable on site (excluding **SEASON**).
- Weekly timer, weekend and public holiday timer (excluding **SEASON**).
- ▲ Pressure sensor detects dirty fresh air filter and notifies faults to control panel (dry contact in **SEASON** version).
- Pressure sensor checks air flow at each fan and notifies faults to control panel (dry contact in **SEASON** version)
- ▲ Lockable proximity switch mounted on the top panel.
- ▲ The **EASY** controller (excluding **SEASON**) ensures the optimal operation and performance of the **FREETIME®** via its integrated temperature sensors:

Outside air sensor
Building ambient air temperature (on extraction) sensor
Injected air sensor.

EASY control enables optimal energy input from fresh air and ensures the following ecological® functions:

- **FREE COOLING:** Mainly in summer, if the exterior temperature is lower than the interior temperature and the **FREETIME®** unit (excluding **SEASON**) is in cooling mode, the rotating exchanger slows and runs adaptively until stopping completely, in order to bring cool air from outside into the building for free. If this operation is not enough to reach the set point temperature, the cooling unit will start up.
- **FREE HEATING:** Mainly in mid-season, if the exterior temperature is higher than the interior temperature and the **FREETIME®** unit (excluding **SEASON**) is in heating mode, the rotating exchanger slows and runs adaptively until stopping completely, in order to bring warm air from outside into the building for free. If this operation is not enough to reach the set point temperature, the heating unit will start up.



- **COLD RECOVERY:** In summer or in mid-season, if the exterior temperature is higher than the interior temperature and the **FREETIME®** unit (excluding **SEASON**) is in cooling mode, the rotating exchanger starts and runs adaptively until reaching its nominal speed, in order to prevent warm exterior air from entering directly. If this operation is not enough to reach the set point temperature, the cooling unit will start up.

In the **SEASON**, version, the cold recovery mode will be active when the exterior temperature is higher than 24°C (adjustable).

- **HEAT RECOVERY:** In winter or in mid-season, if the exterior temperature is lower than the interior temperature and the **FREETIME®** unit (excluding **SEASON**) is in heating mode, the rotating exchanger starts and runs adaptively until reaching its nominal speed, in order to prevent cold exterior air from entering directly. If this operation is not enough to reach the set point temperature, the heating unit will start up.

In the **SEASON**, version, the heat recovery mode will be active when the exterior temperature is lower than 18°C (adjustable).

- **NIGHT COOLING:** The night cooling function (excluding **SEASON**) allows the building's interior temperature to be lowered according to climate conditions over the preceding 24 hours. Thus, between midnight and 7am (period is adjustable) the night cooling function activates if the exterior temperature has exceeded 22°C (adjustable) during the day (between 6am and 10pm). Night cooling operates if the exterior temperature is between 10 et 18°C (adjustable) and the extraction temperature is higher than 18°C (adjustable).

- ▲ In addition, this function includes a ventilation set point specific to the selected flow rate, in **FIRST** and **PREMIUM** versions fitted with the **EASY** controller.

- **FIRE SAFETY:** As standard, the **FREETIME®** unit (excluding **SEASON**) includes a fire safety device that can control the injection and extraction fans in 5 different modes, available in the settings (function to be activated on site).

"Stop": Shuts down the unit completely.

"Run": Starts up or runs the unit at high speed; the fire safety function will take priority over all other alarms.

"Auto": Runs the unit according to the on-site settings (Stop/Slow/Fast).

"Run Injection": Starts up or runs the injection fans at high speed (extraction stopped).

"Run Extraction": Starts up or runs the extraction fans at high speed (injection stopped).

Whichever mode is selected, the **EASY** icon control screen will display "Fire Alarm" when this function is activated.

The **FREETIME®** unit also includes an "External Stop" digital port which allows a manual controller to be connected on site.

In this case, the external controller takes priority over any fire safety activated by any of the 5 modes listed above.

FLOW RATE ADJUSTMENT

- ▲ 6 flow rate options to guarantee optimal energy consumption (RT2012, EN15232).

SEASON: Rotation speed of each fan can be adjusted using potentiometers mounted and wired to the unit's top panel.

- In the **FIRST** and **PREMIUM**, versions, the **EASY** controller can run fans in the following modes:

ECO: Rotation speed of each fan can be adjusted by altering the two flows (low-/high-speed) in the **EASY** controller.

LOBBY®: flow rate at **CONSTANT PRESSURE**, adjustable for each fan (**FIRST** and **PREMIUM**).

DIVA®: Proportional flow adjustment of each fan according to CO2 level. Sensor integrated into the unit's extraction duct.

MAC2®: **CONSTANT FLOW** adjustment of each fan (low & high speed) (excluding 500 and 800 models). Pressure transmitters integrated into the unit.

QUATTRO®: **CONSTANT FLOW** adjustment of each fan according to CO2 level (excluding 500 and 800 models). Pressure transmitters and CO2 sensor (in extraction duct) integrated into the unit. Low speed, high speed and CO2 (ppm) can be adjusted on site in the **EASY** controller.

INSTALLATION

- ▲ Indoors in cabinet or plant room.

- ▲ Compact design, top-mounted connectors via circular connectors with joints for simple, quick, airtight and economical installation (no adapters).

CLIMATE VERSIONS

- ▲ The **FREETIME®** unit includes the **PREMIUM BC** (integrated water heater) and **PREMIUM BE** (integrated electric heating) extras, ensuring optimal usage in winter down to -20°C (excluding **SEASON**).

This functionality is managed automatically by the "**EASY**" controller.

- ▲ Additionally, and ensuring climatic comfort in all seasons and climates, the **FREETIME®** unit (excluding **SEASON**) can be linked to a cooling or dehumidifying module:

- The **COMBIBOX CONCEPT®** cold water (CBX-BF) module on all versions and can be used for changeover on the **FIRST** version.

- Direct expansion module CBX-DX to R410A.

- Dehumidification module only on **FIRST** versions.

- ▲ The "**EASY**" controller integrated into the **FREETIME®** unit enables management of these thermal modules.

- ▲ The dehumidification function (to be activated on site) involves linking the **FREETIME®** unit to a **COMBIBOX CONCEPT®** module equipped with a cooling unit (water or cold DX only) plus a heating unit (water or electric). In this case, the controller will automatically manage the hot or cold supply necessary for dehumidification, while maintaining an optimal operating temperature. When in cooling mode, temperature management takes priority over dehumidification.

Versions	COMBIBOX CONCEPT® EXTERNAL MODULE							
	HEATING		REFRESH Cold Only		DEHUMIDIFYING Cold + Warm			
	Electric	Water	Water	R410A	Water/Water	Water/Elec	R410A/Water	R410A/Elec
SEASON	-	-	-	-	-	-	-	-
PREMIUM BE	✓	--	CBX-BF	CBX-DX	-	-	-	-
PREMIUM BC	-	✓	CBX-BF	CBX-DX	-	-	-	-

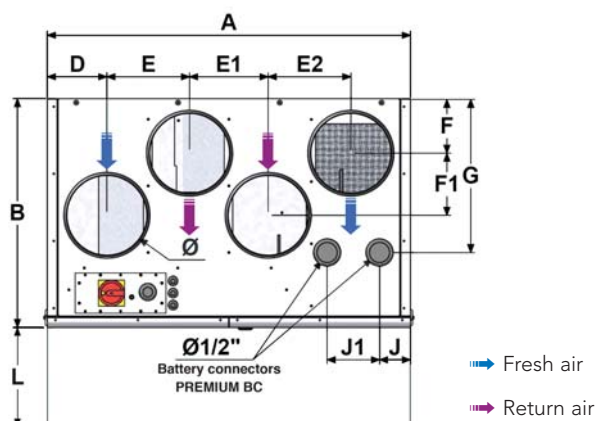
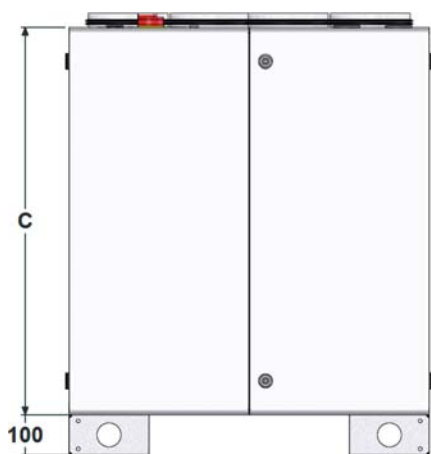

FREETIME® model	∅	A	B	C	D	E	E1	E2	F	F1	G	J	J1	L	SEASON	PREMIUM BE PREMIUM BC
	mm	mm	mm	mm	mm	mm	mm	mm	mm	mm	mm	mm	mm	mm	kg	kg
500	200	900	570	970	145	205	195	205	135	155	385	75	130	520	130	135
800	250	1080	700	1090	170	235	240	260	160	235	485	75	180	650	170	175
1500	315	1400	750	1140	230	315	310	315	210	190	585	100	230	720	225	232
2000	355	1500	830	1220	250	335	330	335	230	230	660	100	230	770	270	278
2700	400	1610	920	1420	270	345	345	375	250	290	755	100	230	820	345	355
3500	450	1730	1085	1420	300	365	370	400	275	390	795	100	305	980	420	432

 ELECTRICAL
 CHARACTERISTICS **FREETIME®**

FREETIME® model	Electrical power (W)	Usage temp. (°C / °C)	Protection index Classe	Thermal cutout *	SEASON/FIRST & PREMIUM BC		PREMIUM BE	
					Power supply voltage (V / Ph / Hz)	Protection current (A)	Power supply voltage (V / Ph / Hz)	Protection current (A)
500	2 x 169 W	-20 / 60	IP54 / B	PTI	230 / 1 / 50	3,8	230 / 1 / 50	14,7
800	2 x 220 W	-20 / 60	IP44 / B	PTI	230 / 1 / 50	4,1	230 / 1 / 50	20,4
1500	2 x 750 W	-20 / 40	IP54 / B	PTI	230 / 1 / 50	7,6	230 / 1 / 50	30,4
2000	2 x 750 W	-20 / 40	IP54 / B	PTI	230 / 1 / 50	7,6	400 /3+N / 50	18,5
2700	2 x 1000 W	-20 / 50	IP54 / B	PTI	400 /3+N / 50	4,3	400 /3+N / 50	23,8
3500	2 x 1000 W	-20 / 50	IP54 / B	PTI	400 /3+N / 50	4,3	400 /3+N / 50	28,1

*PTI: Integrated thermal cutout

- The "Lp4m dB(A)" curves indicate the sound pressure level measured at 4m, in free field conditions, with hemispherical distribution on a reflecting plane, disconnecting the exterior "fresh air intake" and "stale air expulsion" ducts and connecting the interior "fresh air injection" and "stale air extraction" ducts.
- To obtain the overall sound pressure level Lp dB(A), at a given distance, add the values below to Lp4m

Distance (m)	1,5	3	4	5	7	10
Distance weighting dB(A)	9	3	0	-2	-5	-8

NOTA: Tolerance =
Global Values + / - 3 dB(A)
Acoustic spectra +/- 5 dB(A)

- The "LW fresh air injection dB(A)" curves indicate overall sound power emitted at the "fresh air injection" duct.
- To obtain the "LW fresh air injection dB(A)" sound power spectrum at the "fresh air injection" duct, add the values below to the "LW fresh air injection" sound power taken from the curves.

Downstream acoustic spectrum weighting function "Lw cond blower dB(A)" Indicated on the curves								
Frequency	63 Hz	125 Hz	250 Hz	500 Hz	1000 Hz	2000 Hz	4000 Hz	8000 Hz
Weighting FREETIME 3500 dB(A)	-26	-18	-12	-10	-4	-6	-10	-13

- The "LW stale air extraction dB(A)" curves indicate overall sound power radiated at the "stale air extraction" and "fresh air injection" ducts.
- To obtain the "LW stale air extraction dB(A)" sound power spectrum at the "stale air extraction" and "fresh air injection" ducts, add the values below to the "LW stale air extraction" sound power taken from the curves.

Upstream acoustic spectrum weighting function "Lw cond extraction dB(A)" Indicated on the curves								
Frequency	63 Hz	125 Hz	250 Hz	500 Hz	1000 Hz	2000 Hz	4000 Hz	8000 Hz
Weighting FREETIME 3500 dB(A)	-30	-19	-9	-7	-7	-5	-10	-16

- To obtain the "NSC4 dB(A)" sound pressure (sound level measured at 4m, in free field conditions, with hemispherical distribution, placing the appliance on the floor on a reflecting plane, with its inlet and outlet ducts connected to ducts having the same sound insulation properties), add the value from the table below to the "Lp4m" value read from the curves.

Acoustic weighting for the value NSC 4 dB (A) depending on the Lp4m value indicated on the curve					
FREETIME 500	FREETIME 800	FREETIME 1500	FREETIME 2000	FREETIME 2700	FREETIME 3500
-18	-18	-19	-20	-20	-21

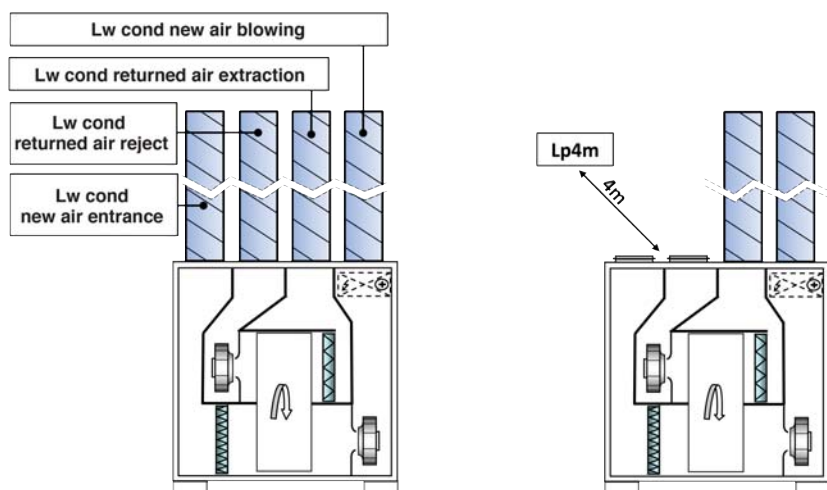

NOTA : the curves are created on the basis of new air (Static Pressure) all pressure gauges connected (configuration D in accordance with regulation NF EN 13141-4)

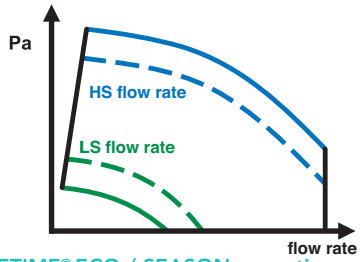

FREETIME® ECO / SEASON operation

1 or 2 flow rates as required (Low Speed(LS)/High speed(HS)) per fan
 Except SEASON, 1 flow adjustable by potentiometer

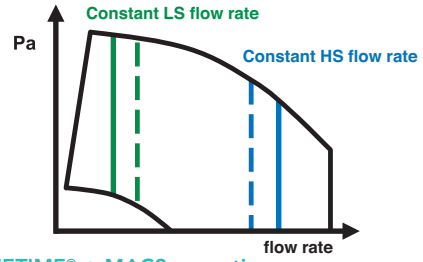

FREETIME® + MAC2 operation

Optional 1 or 2 CONSTANT flow rates by fan (except FREETIME® 500 and 800)

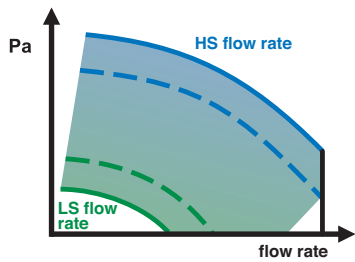

FREETIME® + DIVA operation

PROPORTIONAL ventilation between two flow rates (LS/HS) by fan

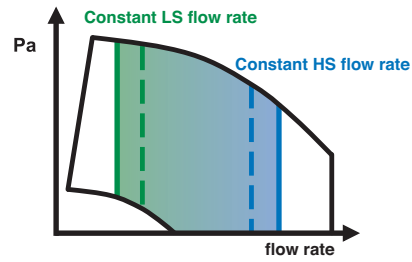

FREETIME® + QUATTRO operation

PROPORTIONAL ventilation between two CONSTANT flow rates by fan (except FREETIME® 500 and 800)

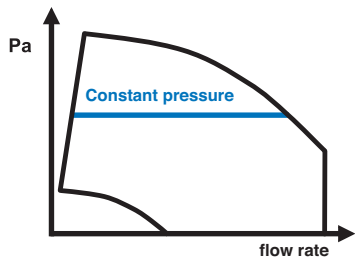

FREETIME® + LOBBY® operation

CONSTANT PRESSURE ventilation by fan



Touchscreen (EXCEPT SEASON)
 with user interfaces and screen
 and / or maintenance interface
 (Up to 100 m)



EQUIPMENT	FIRST	PREMIUM BE	PREMIUM BC
Low-consumption EC fans	●	●	●
Fresh air filter, opacimetric F7	●	●	●
Extraction filter, gravimetric G4	●	●	●
High-efficiency (>80 %) rotating exchanger, EUROVENT certified	●	●	●
Variable-speed exchanger	●	●	●
Double skin 50 mm RAL7035 (except 500 & 900 = 25 mm)	●	●	●
Circular connectors with lip joints (ATEC CSTB no. 13-224-12)	●	●	●
Touchscreen remote control (up to 100m)	●	●	●
Control protocols - MODBUS or BACNET via RS485 or TCP/IP or WEB (select in menu)	●	●	●
Control fan speed (LO - HI) using EASY controller	●	●	●
Fan speed adjustment potentiometers	-	-	-
Supply temperature sensor	●	●	●
Extraction temperature sensor	●	●	●
Exterior temperature sensor	●	●	●
Frost protection thermostat on water heating unit	-	-	●
Safety thermostat on electric heating unit	-	●	-
Exchanger rotation sensor	●	●	●
Lockable proximity switch	●	●	●
Power cable guide	●	●	●
FUNCTIONS	FIRST	PREMIUM BE	PREMIUM BC
Self-regulating electric heating unit	-	●	-
Self-regulating water heating unit	-	-	●
Optimised free cooling	●	●	●
Optimised free heating	●	●	●
Managed night cooling (night-time overventilation)	●	●	●
Optimised cold recovery	●	●	●
Thermostatic control of cold recovery (adjustable)	-	-	-
Optimised heat recovery	●	●	●
Thermostatic control of heat recovery (adjustable)	-	-	-
Supply temperature management (air legislation)	●	●	●
Ambient temperature management (extraction)	●	●	●
Weekly timer	●	●	●
Weekend and public holiday timer	●	●	●
Dirty fresh air filter pressure sensor	●	●	●
Airflow monitoring pressure sensors (injection & extraction)	●	●	●
Fire safety with 5 available modes	●	●	●
Managed COMBIBOX CONCEPT® cooling module (water or R410A)	●	●	●
Managed COMBIBOX CONCEPT® dehumidification module	●	●	●
FACTORY-FITTED OPTIONS	FIRST	PREMIUM BE	PREMIUM BC
LOBBY®: flow rate at CONSTANT PRESSURE	○	○	○
DIVA®: proportional flow adjustment by CO2 level	○	○	○
MAC2: CONSTANT FLOW adjustment	○	○	○
QUATTRO EC: proportional adjustment by CO2 level between 2 CONSTANT FLOWS	○	○	○
ON-SITE OPTIONS	FIRST	PREMIUM BE	PREMIUM BC
COMBIBOX CONCEPT® cooling module (water or R410A)	◆	◆	◆
COMBIBOX CONCEPT® dehumidification module	◆	◆	◆
Changeover chip for switching hot/cold	◆	◆	◆
LON protocol communications	◆	◆	◆
Ambient temperature control via touchscreen remote control	◆	◆	◆
WONDEROOM zone controller communicating automatically with the FREETIME®	◆	◆	◆

● : Standard equipment or functions.
 ○ : OPTIONAL equipment or functions. Supplied assembled and cabled at the factory
 ◆ : OPTIONAL equipment or functions. Supplied unassembled



FREETIME® 3500

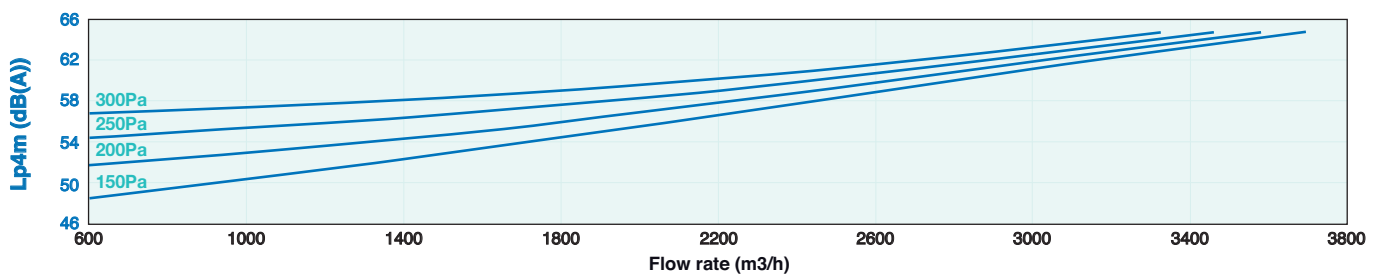
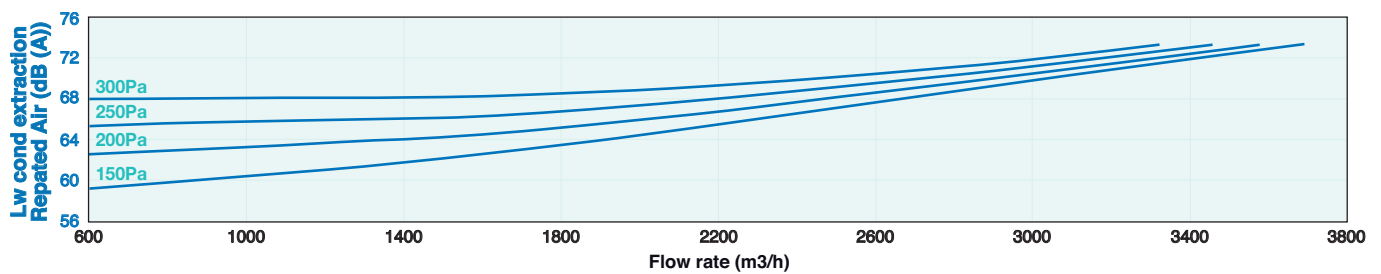
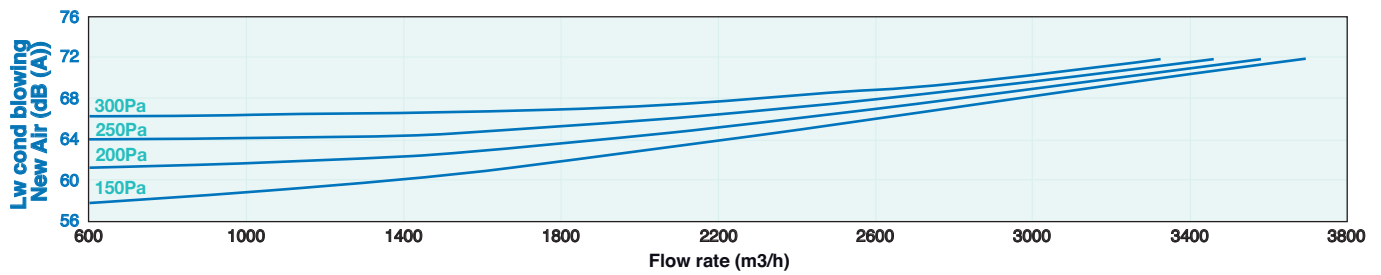
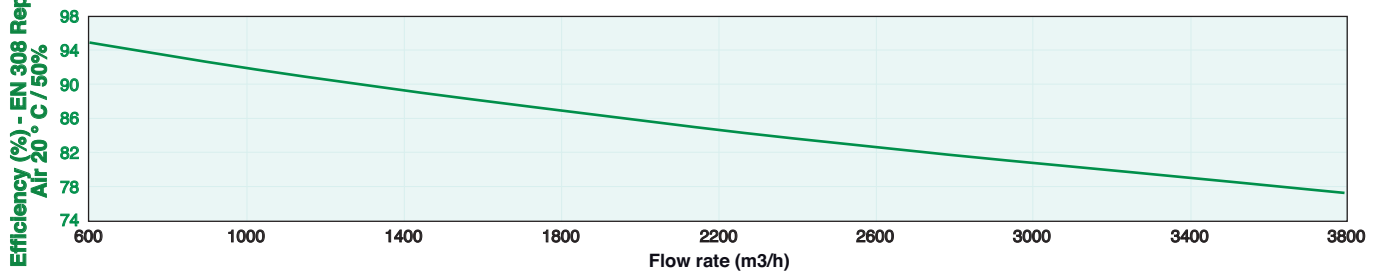
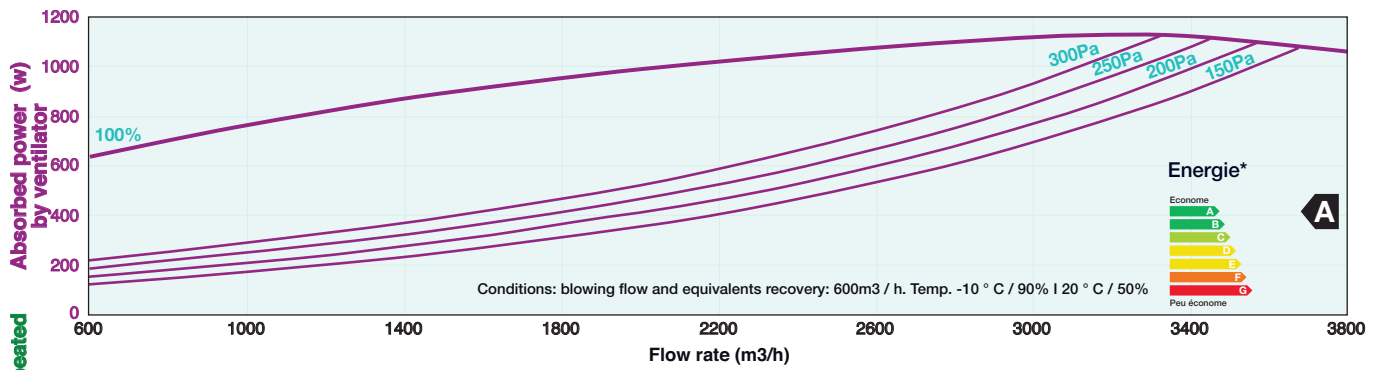
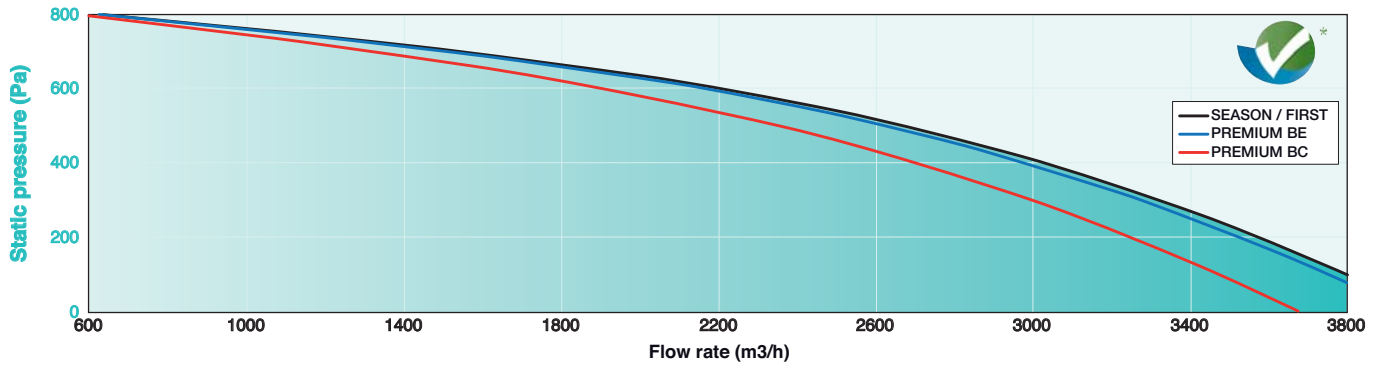



FREETIME® 3500

Hot water coil - PREMIUM BC

Water temp. (°C/°C)	Air inlet temp. (°C)	Fl rate (m³/h)	1000	1400	1800	2200	2600	3000	3400
80/60	11	Motor (kW)/Air outlet temp (°C)	12,7 / 48,3	15,9 / 44,3	18,7 / 41,4	21,1 / 39,1	23,3 / 37,2	25,3 / 35,7	27,1 / 34,3
		Water flow(l/h)/DP water (kPa)	558 / 2,5	683 / 3,7	8 / 5	925 / 6,2	1021 / 7,4	1108 / 8,6	1188 / 9,8
80/60	15	Motor (kW)/Air outlet temp (°C)	11,9 / 49,7	14,8 / 45,9	17,4 / 43,2	19,6 / 41,1	21,6 / 39,6	23,5 / 37,9	25,2 / 36,7
		Water flow(l/h)/DP water (kPa)	519 / 2,2	649 / 3,2	761 / 4,3	859 / 5,4	948 / 6,5	1029 / 7,5	1103 / 8,6
60/50	11	Motor (kW)/Air outlet temp (°C)	9,6 / 38,9	12 / 36	14,1 / 33,9	15,9 / 32,2	17,6 / 30,8	19,2 / 29,7	20,6 / 28,7
		Water flow(l/h)/DP water (kPa)	830 / 5,3	1042 / 8,1	1225 / 10,9	1387 / 13,6	1533 / 16,4	1666 / 19,1	1788 / 21,8
60/50	15	Motor (kW)/Air outlet temp (°C)	8,7 / 40,3	10,9 / 37,7	12,8 / 35,7	14,4 / 34,2	16 / 33	17,3 / 31,9	18,6 / 31
		Water flow(l/h)/DP water (kPa)	753 / 4,5	945 / 6,7	1110 / 9,1	1256 / 11,4	1388 / 13,7	1508 / 15,9	1619 / 18,1
45/40	11	Motor (kW)/Air outlet temp (°C)	6,9 / 31	8,6 / 29	10,2 / 27,5	11,5 / 26,3	12,7 / 25,3	13,8 / 24,5	14,9 / 23,8
		Water flow(l/h)/DP water (kPa)	1185 / 10,6	1491 / 16,2	1756 / 21,8	1991 / 27,5	2203 / 33,1	2396 / 38,7	2574 / 44,1
45/40	15	Motor (kW)/Air outlet temp (°C)	6 / 32,5	7,5 / 30,7	8,8 / 29,3	10 / 28,3	11,1 / 27,4	12 / 26,7	12,9 / 26,1
		Water flow(l/h)/DP water (kPa)	1032 / 8,2	1297 / 12,5	1527 / 16,9	1730 / 21,2	1914 / 25,6	2081 / 29,8	2235 / 34

FREETIME® 3500

Electric coil - PREMIUM BE

Fresh air Flow rate (m³/h)	0°C 3500	-5°C 3500	0°C 3500	-5°C 3500	-10°C 3500	-15°C 3500	-20°C 3500
Version	FIRST-SEASON		PREMIUM BE				
			Heating coil				
Total power kW	-		16,5				
Temp. °C on output from the unit	15,7	14,6	29,8	28,7	27,1	26,4	25,3





• SECURITY AND CONTROL

**PRESSOSTAT
FOULING ref. DEP**

Return air Filter (IP54)

**MANOMETER
WITH LIQUID J
ref. MANO****SMOKS ALARM
ref. CDAD**

Cabinet (IP54)

**BOX RELEASE
ref. BD**TBTS 24 or 48Vcc
CASE (IP67)

• INSTALLATION

**FLEXIBLE SLEEVE ref. MTS M0**Fire classification: M0
Male diameters (supply) / Female (Central side)**CIRCULAR REGISTER
ref. RC4A**Frost protection or isolation. Waterproof class 4
Ø 200 to 450

• RÉGULATION

**REGULATOR OF ZONE
MONOFUNCTION ref. SYSTEM TOP**Zone Control All Or Not to associate with versions
LOBBY® flow modulation rate (constant pressure).**REGULATOR OF ZONE
MONOFUNCTION ref. SYSTEM DIVA**Modulating zone controller to associate with versions
LOBBY® flow modulation rate (constant pressure).**MULTIFUNCTION ZONE REGULATOR
ref. WONDEROOM**To associate with the versions modulation of flow miss
LOBBY® (Constant pressure). Besides the management of
the zone. Regulator communicates with the power plant
NEOTIME®

• MODULATION FLOW

**DEPORTED
COMMAND
ref. POT VF**Potentiometer only for
SEASON (IP54)**COMMANDED
OUTSTRIP COMFORT
ref. CDC1V2**On/off/PV/GV 2 Ventilators
CASE (IP54)**COMMANDED
OUTSTRIP COMFORT
ref. CDC2V2**STOP /PV/GV 2 Ventilators
CASE (IP54)**COMMANDED
OUTSTRIP
COMFORT
ref. CDC PVGV2**PV/GV 2 Ventilators CASE
(IP54)**PRESENCE
DETECTOR
ref. 360 TOR SA**ON/OFF or
PV/GV(SEASON
incompatible version)

• CLIMATIC

**THERMOSTAT REVERSER
SUMMER/WINTER
ref. CHANGEOVER PAD**

For versions FIRST + CBX-BF used in changeover

**DUCT HUMIDITY SENSOR
ref. HR 010 SG**

Signal 0-10V (SEASON incompatible version)

**DUCT HUMIDITY SENSOR
ref. HR 010 SA**

Signal 0-10V (SEASON incompatible version)

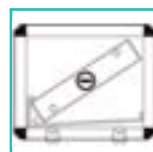
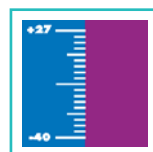
**DIRECT EXPANSION MODULE
R410A ref. CBX DX**Installation in ducts (to see chapter
AIR TREATMENT for descriptions).
SEASON incompatible version**DEHUMIDIFYING MODULE
ref. CBX --**Installation in girdle (to see chapter
AIR TREATMENT for descriptions).
SEASON incompatible version**KIT ÉLECTROVANNE réf. KEI IP44**PREMIUM BC versions
Type 15/1.6-3/8" M for FREETIME® 500 and 800
Type 15/2.5-1/2" M for FREETIME® 1500, 2000
and 2700
Type 15/4-1/2" M for FREETIME® 3500