



# EXAECO™

## RANGE

Very high efficiency, high performance, self-regulating double flow unit. Ecological solution™ compliant with ErP2012.





ERP2018  
CALADATX EFFECT

bluetech  
MADE BY CALADATX

## APPLICATION

- ✦ Ventilation, **energy recovery**, thermal comfort and innovating and optimal treatment of indoor air quality. **Self-regulated, high efficiency** and **high-performance** unit for office and industrial installations.
- ✦ Efficiency greater than **80 %** (EN308), complies with **RT 2012** and directive **2009/125/EC**.
- ✦ New levels of air **filtration** and **purification**, control and optimization of energy consumption.
- One- or two-piece smart, plug and play unit (EN15232).

## RANGE

- Available in 4 sizes and 8 models, the **EXAECO®** range covers air flows from 5 000 to 22 000 m<sup>3</sup>/h.

The **EXAECO®** range is offered in 4 versions each available, on the fresh air side, with right- or left-hand access:

- **EXAECO®**: self-regulated energy recovery unit without heating batteries, with **FEE®** function for optimization of energy consumption.
- **EXAECO ELITE®**: **EXAECO®** unit combined with the **ELITE** module for climatic comfort with the choice of one or a combination of two heating battery: water heating battery, electric heating battery, changeover battery, water cooling battery, direct expansion battery, cold only or reversible.

## CONSTRUCTION

The **EXAECO®** range together with its associated **ELITE**, **PURE** and **EDEN** modules are designed and manufactured in compliance with the **EUROVENT** certification processes and meet current European standards (EN1886, EN13053, etc.) to guarantee mechanical strength, sealing, acoustic levels and technical performance.

- ✦ Structure in aluminium profile with **thermal breaks** using polyamide spacers built into the profile (class TB2 in accordance with EN1886).
- Corners in reinforced polyamide.
- Double skin panels 10/10th (Class D2 in accordance with EN1886).
- ✦ Insulation: 50 mm high density 50 mm A1 (M0) (L1 and T2 class for airtightness of the envelope according to EN1886).
- External surface: RAL7035 pre-lacquered metal sheet with protective film.
- Internal surface: galvanized steel.
- Frame in heavy gauge 30/10 galvanized steel. Module ELITE on galvanised feets.
- For external installations, a roof must be integrated (option).
- ✦ Access to the internal components by pivoting doors with progressive locking handles along with a safety latch on all doors.

## EXAECO® EQUIPMENT

### MOTOR FANS

- ✦ Plug fans in epoxy-treated galvanised steel.
- The design of the **EXAECO®** range (position of the fans) minimises a leaks of return air to the blast air as much as possible and limits the exterior leakage rate caused by the rotating heat exchanger.
- ✦ Direct drive DC motor with high efficiency electronic (EC) thermal cut-out and speed variation integrated for model 10.  
Direct drive motor, IE2/IP55, thermal cut-out and frequency converters incorporated on models 13 and 17, synchronous motor **with permanent magnet IE3/IP55** and frequency converter for model 22.
- ✦ All **EXAECO®** models comply with phase 2 (2015) of directive ERP 2009/125/EC.
- Several air flow modulations are available.

## DOUBLE FLOW UNIT DESCRIPTION

# EXAECO™

### HEAT EXCHANGER

High efficiency rotating heat exchanger in aluminium, with **variable speed**. Heat exchanger in a rigid frame mounted on slides for easy extraction and maintenance.

Rotating air-air heat exchangers produced by KLINGENBURG which participates in the **Eurovent** certification program for the AARE.



INTEGRATED EXCHANGER

When used for local high humidity, provide a tray condensate (option) under the rotary exchanger.

### FILTERS

▲ The **EXAECO™** control unit is equipped as standard with the **CLEARMOTION™** device, which ensures a high level of security. High Indoor Air Quality and an **ecological solution™** for optimal efficiency at low consumption.

- Fresh Air Filtration  
The control unit **EXAECO™** has a double slide with a bead seal to ensure that watertightness. It is fitted as standard with a high efficiency **F7 (ePm1 55%)** filter with low pressure drop. As an option, the **EXAECO™** can be equipped with a double filtration stage: **M5 filter (ePm10 50%)** in order to obtain an M5 + F7 combination. **F9 filter (ePm1 80%)** to obtain an F7 + F9 device.

- Extract Air Filtration  
Standard filter: **F7 (ePm1 55%)**
- The filters are always mounted upstream of the components to ensure protection.
- Mounted on slides for easy replacement with bead seal (fresh air filter) to guarantee watertightness.

### 3-WAYS MODULE

- As standard, the **EXAECO®** range is fitted with a motor-driven 3-ways mixing system, using class 4 opposing displacement aluminium profiled blades.
- ✦ The registers composing this 3-way module are controlled and automatically managed by the regulation system and provide anti-freeze, insulation and fire safety functions (register downstream of the fresh air filter), optimization of energy gains and quality of the indoor air (**EXAECO PURE®** and **EXAECO EDEN®**) on start-up (recirculation) and when the unit is in operation using the **FEE®** principle: **Free Energy Efficiency** (see features section).

### PROBES

The **EXAECO®** module is fitted as standard with:

- ✦ Outdoor/fresh air temperature probe, air supply probe, return air temperature probe and CO<sub>2</sub> probe. These probes are all fitted and wired in the unit and connected to the regulation system. They carry out all the functions enabling the unit to operate optimally in accordance with the actual requirements of the installation and are involved in the implementation by the regulation system of free-cooling, night-cooling, cold recovery, recirculation and **the ecological FEE® solution** (Free Energy Efficiency).

### ELECTRICAL COMPARTMENT AND REGULATION SYSTEM

This sealed compartment incorporated into the unit includes all the electrical components and regulation system.

- ✦ Provided with pivoting doors fitted with progressive closure handles and a safety latch, this compartment contains the electrical control panel, the smart regulation system using and the inverters for the motors (models 13 to 22).

The access door to the electrical compartment accomodates a display panel with an IP65 LCD screen for interior or exterior installation and a lockable switch.



- The display on the front panel gives access to the settings and setpoints of the regulation system. A fixed strip fitted with grommets allows the unit to be electrically connected providing quick and simple installation.
- ✧ A remote control with features similar to the display panel (from 10m to 1km combined with repeater), or a touch user screen for temperature control, restart, default, etc. functions may be connected to the regulator present in the compartment. (up to 100 m).
- Weekly internal timers allow operation at two air flows, programmable as required on site with two setting periods per day for each flow rate.
- Timer for setting annual holidays and public holidays.
- Weekly timer for starting/stopping recirculation.
- ✧ The regulation system integrated into the EXAECO® unit enables to manage the various configurations of the ELITE climatic module.

### EXAECO ELITE® EQUIPMENT

The EXAECO ELITE® version combines an ELITE module with the same cross-section as the EXAECO® unit enabling heating coils to be incorporated in the system to provide climatic comfort suited to the environmental conditions and the operating requirements of the building. This module can be fitted with:

- Hot water coil only (H).
- Electric heating battery (E).
- Hot water battery and cold water battery (HC).
- Electric heating battery and cold water battery (EC).
- Hot water battery and direct expansion battery (HDX).
- Electric heating battery and direct expansion battery (EDX).
- Changeover water battery (CO).
- Cold water battery only (C).
- Cold direct expansion battery only (DX) or reversible (DXR). The direct expansion battery is managed by the outdoor unit. An interface (optional) to the EXAECO® unit regulation system sends a signal to start the chiller unit.

- ✧ As standard, the ELITE modules incorporating a cold battery, or a direct expansion coil are fitted with a stainless steel condensate tray mounted on a runner for quick extraction and easy maintenance. In addition, the module incorporates a removable trap connected on the outlet from the condensate tray and connected to a drain on the

lower part of the module. These internal components are accessed by means of a door with a handle and a safety latch.

- As standard the regulation is delivered in language MODBUS, WEB and BACNET.



### FUNCTIONS

The EXAECO® range is self-regulating, plug and play and communicates on a MODBUS RS485. Based on the principles of high efficiency (more than 80%) energy recovery (EN308 and EUROVENT certification of the heat exchanger), reductions of CO<sub>2</sub> emissions (in compliance with the 2nd step planned in 2015 by directive ErP 2009/125/EC), performance requirements for air conditioning and ventilation systems (EN13779, PSFP less than 1.5), our EXAECO® program incorporates a complete and innovative system for implementing optimal economical® solutions based on temperature criteria (indoor and outdoor) and Indoor Air Quality (IAQ).

### FEE™ : FREE ENERGY EFFICIENCY

- Using the 3-ways module fitted as standard to the EXAECO® range, the FEE® function is managed autonomously and automatically and provides maximum optimization of energy gains.
- ✧ Depending on the outdoor temperature, the blowing temperature instruction (or ambient temperature of exhaust air), the 3-ways module controlled by modulating servomotors provides partial or total recycling (90% to maintain 10% fresh air, adjustable) to limit energy consumption and heat or cold production. This function will also be interlocked to the quality of the extracted air through a CO<sub>2</sub> probe incorporated within the unit which determines to what extent the FEE® function can be used without degrading the indoor air quality (threshold 1000 ppm in compliance with current regulations). This CO<sub>2</sub> threshold (seuil) instruction can be adjusted on site.
- ✧ Depending on the situation, the FEE® function provides energy savings of more than 40%.

### FREE COOLING

- ✧ To optimize the energy contribution from the fresh air, the unit fitted with temperature probes on the outdoor air and the ambient air of the building (probe on the return air) which are used to control the motor to optimize the speed of the rotating heat exchanger. In summer, when the outdoor temperature drops to less than the indoor temperature, the rotating heat exchanger is stopped and the EXAECO® unit operates using fresh air only.

### COLD RECOVERY

During the summer, if the interior temperature is less than the exterior temperature, the rotating heat exchanger operates so as to recover the energy and optimize energy consumption. At this point, the FEE® (Free Energy Efficiency) function will be activated to improve energy savings if the CO<sub>2</sub> content of the indoor air (threshold 1000 ppm adjustable) allows this.

\*In standard, the regulation is delivered in MODBUS, WEB and BACNET.

### NIGHT COOLING

The night cooling function enables the indoor temperature of the building to be lowered according to the climatic conditions over the last 24 hours. Between midnight and 7 a.m. (time slot adjustable), the night cooling function starts if the outside temperature exceeds 22°C (adjustable) during the day (between 6

m. and 10 p.m.).  
Night cooling operates if the outside temperature is between 10 and 18°C (adjustable) and if the exhaust air temperature is greater than 18°C (adjustable).

- ✧ In addition, this function has a specific configured ventilation speed set to 85% (adjustable).

### RECIRCULATION

To optimize the energy consumption of the EXAECO® range, the regulation system enables a timer to be set for the recirculation ranges (outside the LS/HS operating times). During this period, the unit starts up with recycled air only (fresh air and exhaust air dampers closed on the 3-ways module) with gradual run-up of the heat exchanger, fans and batteries (ELITE version) in order to set the temperature of the heat exchanger and indoor environment. For energy saving reasons, the night cooling function takes priority over the recirculation function.

### INDOOR AIR QUALITY

- ✧ As standard, the EXAECO® range is fitted with a CO<sub>2</sub> probe on the exhaust air. This probe allows the 3-ways module to be configured to maintain a suitable CO<sub>2</sub> rate.

### HEAT EXCHANGER FOULING SAFETY SYSTEM

- ✧ To avoid the heat exchanger becoming fouled while the fans are operating and energy recovery is inactive (heat exchanger stopped), the regulation system automatically carries out a rotation of the heat exchanger (average 1 minute per hour).

### FIRE SAFETY

- ✧ The internal regulation cabinet of the EXAECO® unit has two terminals for connecting a "Fireman's stop" on opening which forces the immediate and complete shutdown of the unit (fans, rotating heat exchanger, etc.) and closes the fire safety damper situated downstream of the fresh air filter and the extracted air damper.
- As an option, the unit may be factory-fitted with an optical smoke detector connected to this contact.



### SMART REGULATION

- ✦ The EXAECO® range and its ELITE version are plug and play. The regulation system factory-fitted, wired and tested is integrated into a sealed compartment. As standard, the regulation system is supplied in MODBUS BACNET or WEB.
- ✦ As standard, the EXAECO® unit is fitted with an LCD IP65 screen to the front panel. As an option, it is possible to connect one and/or another of the following remote controls :
  - LCD remote control with the same features as the front panel screen and which can be moved from 10 m to 1 km (requires repeater option) or limited to 10m if the unit is connected to a BMS.
  - User control with touch screen which can be moved up to 100 m whether or not the unit is connected to a BMS.

EXAECO® units are intended for the ventilation and comfort air treatment of indoor environments with average humidity. They are not suited to humid environments such as swimming pools, saunas, sea therapy, laundry, etc.

- ✦ When carrying out **clean air compensation and renewal**, the regulation system of the EXAECO® unit acts on the temperature control according to the season. In Winter, the regulation system controls the blowing temperature according to the outdoor temperature (adjustable air law). If the external temperature goes over 13°C (setpoint adjustable) the the regulation system goes into control mode on the extracted air temperature (setpoint adjustable).
- For **comfort** use (ELITE version) providing **heating and/or cooling**
  - to the building along with **clean air renewal**, the EXAECO® unit regulation system acts on the temperature control of the extracted air from the building (adjustable instruction) or on the ambient temperature (optional ambient probe).
- ✦ The regulator is fitted with a battery which enables users settings to be maintained in the event of a power cut.
- ✦ Changeover from summer time to winter time is automatic (this function can be disabled).

ÉQUIPEMENTS	FIRST	ELITE E	ELITE H	ELITE CO	ELITE DXR
Low energy consumption EC fan motors					
Opacimetric, F7 fresh air filter					
Opacimetric, F7 exhaust air filter					
High efficiency Rotary Heat Exchanger (>80%). EUROVENT certified					
Variable speed Rotary Exchanger					
50mm, RAL 7035 double skin					
Remote LDC display (IP65)					
MODBUS or BACNET communication management in RS485 or TCP / IP or Web (selection access on the menu)					
Commissioning Speed(s) LS-HS with regulation EASY					
Blowing temperature sensor					
Exhaust air sensor					
Outside temperature sensor					
Defrost sensor on water battery	-	-			-
Inclined condensate trays for DX changeover battery	-	-	-		
Safety thermostat on electric heating battery	-		-	-	-
Rotation exchanger sensor					
Lockable proximity switch					
Power cord grommet					
FUNCTIONS	FIRST	ELITE E	ELITE H	ELITE CO	ELITE DXR
Self-regulating electric heating battery	-		-	-	-
Self-regulating water heating, cooling or changeover battery	-	-		-	-
Cold water battery or reversible	-	-	-		-
Expansion and reversible R410A battery	-	-	-	-	
Free-Cooling optimum management					
Free-Heating optimum management					
Night-Cooling management (night boost ventilation)					
Recirculation management (FEE module)					
Optimal cooling recovery					
Optimal heating recovery					
Blowing temperature management (air regulation)					
Ambient air management (exhaust air)					
Weekly timer					
Holidays and bank holidays timer					
Fresh air filter pressure switch					
Flow rate pressure switch control (blowing + recovery)					
Fire safety mode (5 modules available)					
FACTORY ASSEMBLED OPTIONS	FIRST	ELITE E	ELITE H	ELITE CO	ELITE DXR
LOBBY®: airflow modulation at constant pressure	m	m	m	m	m
DIVA®: proportional CO <sub>2</sub> flow rate modulation	m	m	m	m	m
MAC2®: airflow modulation at constant pressure	m	m	m	m	m
QUATTRO®: proportional adjustment by CO <sub>2</sub> level between 2 constant flows	m	m	m	m	m
OPTIONS CHANTIER	FIRST	ELITE E	ELITE H	ELITE CO	ELITE DXR
Changeover pad for hot/cold switch on changeover battery	u	-	-	u	-
Remote LCD control (up to 100m)	u	u	u	u	u
Ambient temperature management via LCD remote control	u	u	u	u	u
WONDEROOM® areas temperature management with direct communication to the unit	u	u	u	u	u

Dim (mm)	EXAECO®			
	10	13	17	22
A	2550	2690	2873	2873
A1	830	900	990	990
A2	1564	1704	1884	1884
B	1620	1820	2090	2285
C	2100	2250	2315	2510
D	1110	1310	1580	1770
E	706	806	806	906
E1	245	220	250	250
F	1510	1600	-	-
F1	566	636	726	726
F2	1300	1440	1620	1620
F3	1490	1690	1960	2155
F4	420	445	520	450
G	155	160	160	160
G1	460	500	550	550
G2	475	535	580	560
I	95	130	130	130
I2	60	60	100	90
J	1190	1260	1290	1400
J1	745	830	860	940
J2	1160	1220	1260	1365
J3	695	795	820	900
K	620	690	780	780
K1	320	395	525	525
M	530	500	455	372
M1	780	850	940	940
M2	1514	1654	1834	1834
M3	1275	1475	1745	1940
T*	1" 1/4	1" 1/2	2"	2"
T1*	2"	2"	2"	2"
T2**	1" 1/8	1" 1/8	1" 1/8	1" 3/8
T3**	1" 5/8	1" 5/8	1" 5/8	2" 1/8

\* Steel tube with gas pitch thread \*\* Copper tube

- G-I-J-J1-T: hot water battery (H)
- G1-I-J-J1-T1: cold water battery (C-CO)
- G2-I2-J2-J3-T2-T3: Direct expansion battery (DX-DXR)
- J2 -1 AND J3-1: System 1 of Direct expansion (DX-DXR)
- J2 -2 AND J3-2: System 2 of Direct expansion (DX-DXR)
- J2 -3 AND J3-3: System 3 of Direct expansion (DX-DXR)
- J2 -4 AND J3-4: System =4 of Direct expansion (DX-DXR)

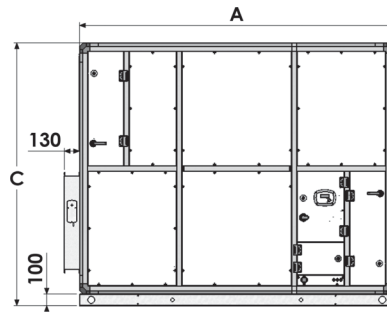

EXAECO®  
10 and 13

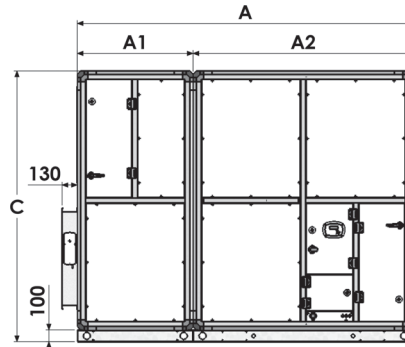

EXAECO®  
17 and 22

SIDE VIEW EXAECO®

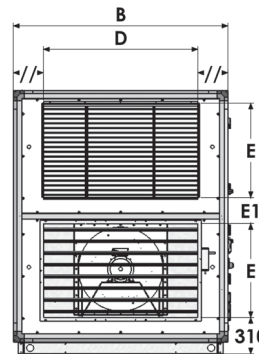

ELITE®MODULE

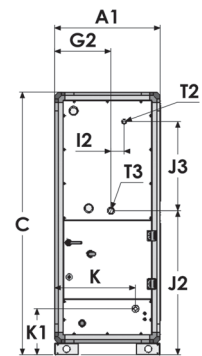

TOP VIEW OF EXAECO® FRAME AND FEET MODULES ELITE®

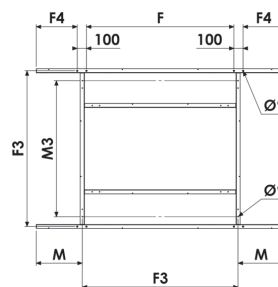

EXAECO® 10 and 13

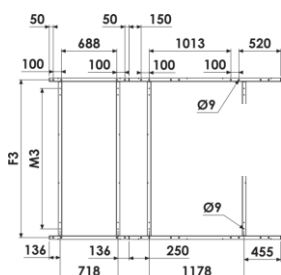

EXAECO® 17 and 22

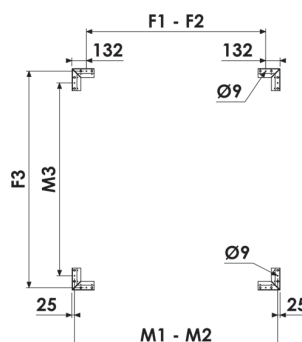

ELITE MODULE

EXAECO® model	EXAECO® Unit (kg)	PURE Module IAQ* (kg)	ELITE Climatic module (kg)		
			H/E	C/CO/DX	HC/EC/HDX/EDX
10	1120	310	270	280	320
13	1350	360	320	330	380
17	550 + 1100	420	370	380	440
22	650 + 1200	470	410	420	490

\*: Indoor Air Quality, innovative and patented technology DBD-Lyse®

ELECTRICAL  
CHARACTERISTICS

Model	Voltage (V / Ph / Hz)	Motor Power (kW)	Current (A)	Working Temp. (°C /)	Protection rating Class	Thermal cutout *	ELITE/EDEN Voltage (V/Ph/Hz)	Electric Heating (E) Protection crnt. (A)
EXAECO 10	400 / 3+N / 50	2 x 3,3 kW	2 x 5,2 A	-20 / 40 °C	IP54 / F	PTI	400 / 3+N / 50	36
EXAECO 13	400 / 3+N / 50	2 x 4 kW	2 x 8,2 A	-20 / 40 °C	IP55 / F	PTC	400 / 3+N / 50	39
EXAECO 17	400 / 3+N / 50	2 x 7,5 Kw	2 x 14,8 A	-20 / 40 °C	IP55 / F	PTC	400 / 3+N / 50	52
EXAECO 22	400 / 3+N / 50	2 x 11 kW	2 x 23,2 A	-20 / 40 °C	IP55 / F	PTC	400 / 3+N / 50	61

\* PTI: Integrated thermal cutout PTC: Thermal protection by PTC probe connected to the regulation system

ELECTRIC BATTERY  
PERFORMANCES

EXAECO® E	Air flow (m³/h)	Electric heating coil E (kW)	Unit output temp. °C	Fresh air temperature °C				
				0	-5	-10	-15*	-20*
10	10000	24,75		23,1	22	20,9	22,1	21,3
13	13000	27		21,9	20,8	19,8	20,9	20,2
17	17000	36		22	21	19,9	21,1	20,3
22	22000	42		21,2	20,1	19	20,2	19,4

\*: With 30% recycled air at 20°C (FEE® function of 3-way module)

KIT SOLENOID VALVE Water rating °C	ELITE H Hot water coil				ELITE C/CO Cold/Changeover coil			RAIN VISOR			
	90/70	80/60	60/50	45/40	45/40	7/12	6/11	H (mm)	J (mm)	K (mm)	Weight (kg)
<b>EXAECO 10</b>	32/16 - 1"1/4 F - IP54				50/40 - 2" F - IP54			706	1110	485	15
<b>EXAECO 13</b>	32/16 - 1"1/4 F - IP54				50/40 - 2" F - IP54			806	1310	550	19
<b>EXAECO 17</b>	50/40 - 2" F - IP54				50/40 - 2" F - IP54			806	1580	550	21
<b>EXAECO 22</b>	50/40 - 2" F - IP54				50/40 - 2" F - IP54			906	1770	610	26

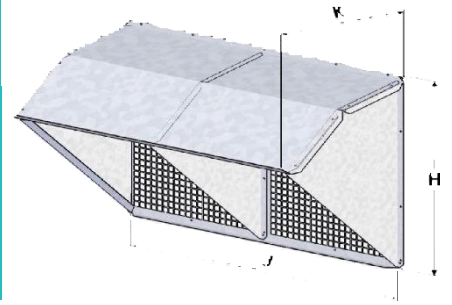



The EXAECO® unit has a factory-programmable regulator as standard used to configure the flow modulations described below:

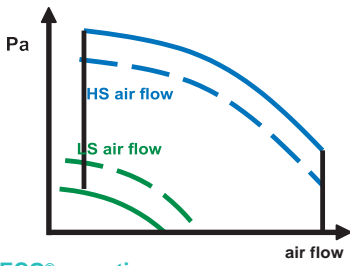

EXAECO® operation

1 or 2 air flows (LS/HS) as required per fan

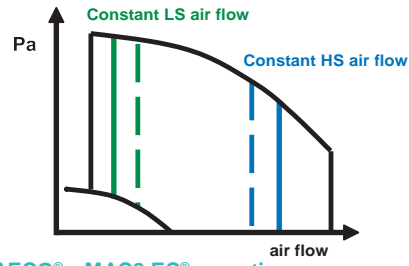

EXAECO® + MAC2 EC® operation

1 or 2 CONSTANT air flows as required per fan

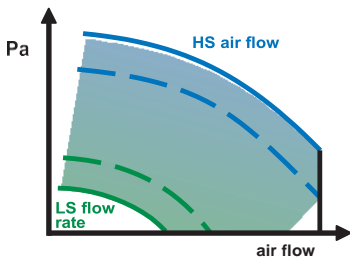

EXAECO® + DIVA EC® operation

PROPORTIONAL ventilation between two air flows (LS/HS) fan for all fresh air operation

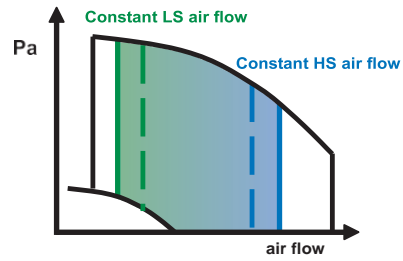

EXAECO® + QUATTRO EC® operation

PROPORTIONAL ventilation between two CONSTANT flow rates per fan for all fresh air operation

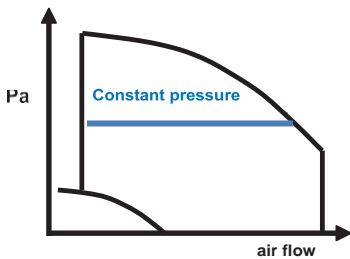

EXAECO® + LOBBY EC® operation

CONSTANT PRESSURE ventilation by fan



User touch screen max. 100m. Functions temperature control, restart, default, etc. Touch wall control ref. ED TOUCH Version not compatible SEASON. Max 100 m.



Remote control with LCD display (optional) max 10 m or 1000 m with repeater (optional).

Same functions as screen on front panel of the EXAECO® unit.



ECONOLOGICAL SOLUTIONS®



Control panel with IP65 LCD display mounted on the front panel of the EXAECO® for adjusting timers, air flows, temperature (proportional management of the 3-ways module, water or electric heating coils, night over-ventilation) checking and readout of defaults, etc.

EXAECO® with AIR FLOW MODULATION	STOP => HS	STOP => LS => HS	STOP => LS	&	LS => HS	FORCE STOP
EXAECO®  Regulation at 1 or 2 adjustable air flows (LS/HS)	TIMER	TIMER	TIMER	&	Dry contact*	LCD control "EASY" or remote à distance or
	or	or		or		
	Dry contact*	Dry contact*	Dry contact*	&	Dry contact*	Dry contact*
EXAECO MAC2 EC®  Regulation at 1 or 2 CONSTANT air flows	TIMER	TIMER	TIMER	&	Dry contact*	LCD control "EASY" or remote control or
	or	or		or		
	Dry contact*	Dry contact*	Dry contact*	&	Dry contact*	Dry contact*
EXAECO LOBBY®  Regulation at adjustable CONSTANT PRESSURE and variable air flows			TIMER			LCD control "EASY" or remote control or
			or			
			Dry contact*			Dry contact*
EXAECO DIVA EC®  Regulation with PROPORTIONAL ventilation between 2 adjustable air flows			TIMER	&	010V CO2 probe	LCD control "EASY" or remote control or
				or		
					010V CO2 probe	Dry contact*
EXAECO QUATTROEC® Regulation with PROPORTIONAL ventilation between 2 CONSTANT adjustable air flows			TIMER	&	010V CO2 probe	LCD control "EASY" or remote control or
				or		
					010V CO2 probe	Dry contact*

Standard function built in to the unit

Optional accessory not fitted

\*Dry contact: CDC type remote control/On-Off CO2 probe/On-Off humidity probe/All types of dry contact, etc.

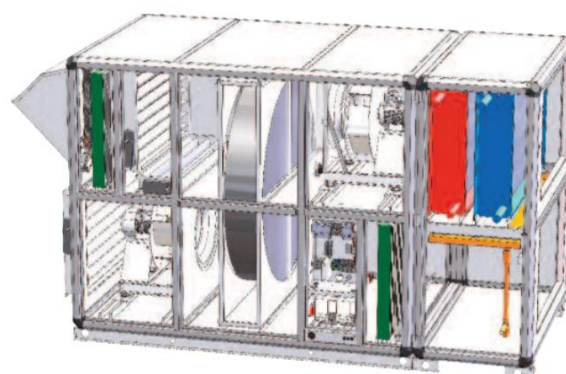



- The “Lp4m dB(A)” curves indicate the sound pressure level measured at 4m, in free field conditions, with hemispherical distribution on a reflecting plane, disconnecting the exterior “fresh air intake” and “stale air expulsion” ducts and connecting the interior “fresh air injection” and “stale air extraction” ducts.
- To obtain the overall sound pressure level LpdB(A), at a given distance, add the values below to Lp4m

Distance (m)	1,5	3	4	5	7	10
Distance weighting dB(A)	9	3	0	-2	-5	-8

NOTA: Tolerance = Global Values + / - 3 dB(A)  
Acoustic spectra +/- 5 dB(A)

- The “LW fresh air injection dB(A)” curves indicate overall sound power emitted at the “fresh air injection” duct. or “Return air rejected”.
- To obtain the spectre of acoustic power Lw cond blowing dB (A), sides “Fresh air blowing” or “Return air rejection”, add the values below to the acoustic power “Lw cond blowing” read on curves.

Downstream acoustic spectrum weighting function “Lw cond blower dB(A)” Indicated on the curves								
Frequency	63 Hz	125 Hz	250 Hz	500 Hz	1000 Hz	2000 Hz	4000 Hz	8000 Hz
Weighting EXAECO 10 dB(A)	-26	-16	-13	-7	-4	-6	-15	-21
Weighting EXAECO 13 dB(A)	-31	-14	-12	-8	-5	-6	-11	-16
Weighting EXAECO 17 dB(A)	-31	-15	-12	-8	-5	-6	-9	-15
Weighting EXAECO 22 dB(A)	-31	-15	-12	-8	-5	-6	-9	-15

- Curves “Lw cond extraction dB (A)” correspond to the global acoustic power shone in girdle sides “Return air extraction” and “Fresh air input”.
- To obtain the acoustic spectre of acoustic power Lw cond extraction dB ( A ), sides “Return air extraction” and “Fresh air input”, Add the values below to the acoustic power “Lw cond extraction” read on curves.

Upstream acoustic spectrum weighting function “Lw cond extraction dB(A)” indicated on the curves								
Frequency	63 Hz	125 Hz	250 Hz	500 Hz	1000 Hz	2000 Hz	4000 Hz	8000 Hz
Weighting EXAECO 10 dB(A)	-19	-9	-7	-5	-8	-9	-16	-22
Weighting EXAECO 13 dB(A)	-26	-9	-7	-7	-6	-8	-12	-19
Weighting EXAECO 17 dB(A)	-26	-10	-7	-7	-6	-7	-12	-18
Weighting EXAECO 22 dB(A)	-31	-15	-12	-8	-5	-6	-9	-15

- To obtain the acoustic spectre NSC4 dB ( A ) (sound level in 4 m in hemispherical open field, device put on the ground on reflecting plan, extremities of the power plant linked with the aspiration and the rejections by girdles of the same sound insulation as this one), to deduct 18 dB ( A ) in the value of Lp4m.

GLOBAL SOLUTIONS EXAECO®

Versions	BATTERY POSITION	EXTERNAL MODULE COMBIBOX CONCEPT®						
		HEATING			REFRESHMENT		CHANGEOVER Hot/Cold	
		Electric	Water	R410A	Water	R410A	Water	R410A
EXAECO	WITHOUT	-	-	-	-	-	-	-
EXAECO ELITE E	BATTERY 1	✓	-	-	-	-	-	-
EXAECO ELITE H	BATTERY 1	-	✓	-	-	-	-	-
EXAECO ELITE CO	BATTERY 2	-	✓	-	✓	-	✓	-
EXAECO ELITE DXR	BATTERY 2	-	-	✓	-	✓	-	✓
EXAECO ELITE EC	BATTERY 1+2	✓	-	-	✓	-	-	-
EXAECO ELITE HC	BATTERY 1+2	-	✓	-	✓	-	-	-
EXAECO ELITE EDX	BATTERY 1+2	✓	-	-	-	✓	-	-
EXAECO ELITE HDX	BATTERY 1+2	-	✓	-	-	✓	-	-

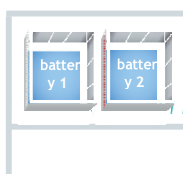

EXAECO® = Energy recovery unit without heating coil.  
EXAECO ELITE® = Energy recovery unit with (1) and/or (2) heating coils.

## EXAECO® 10

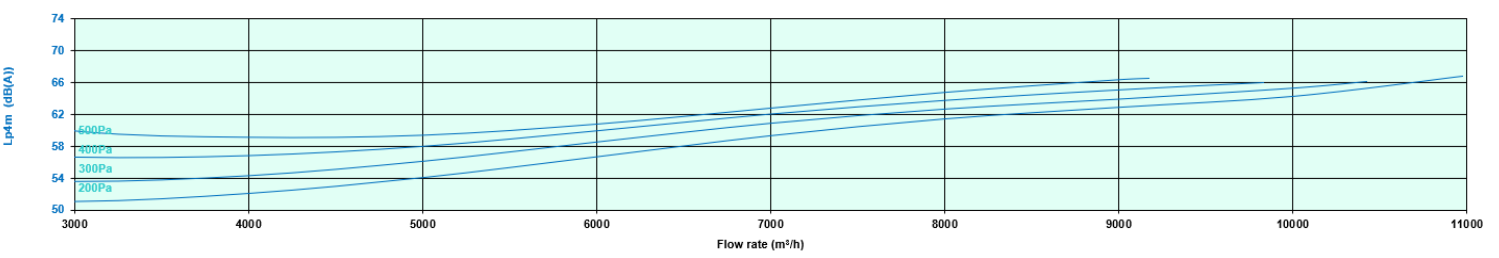
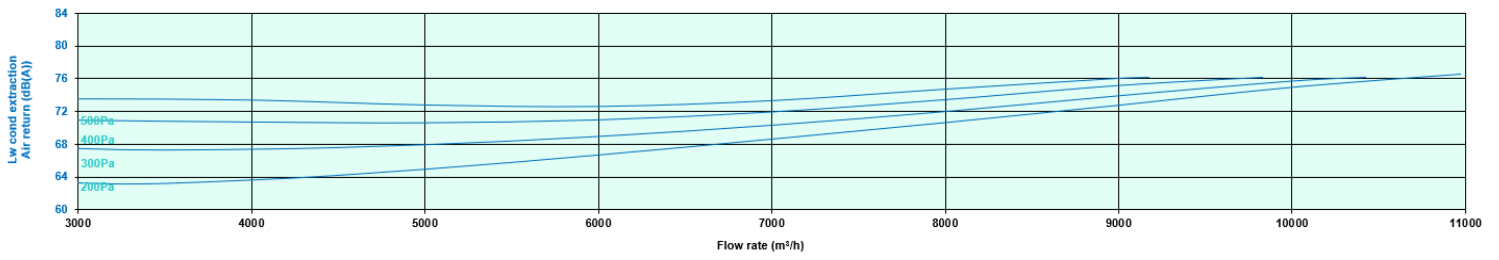
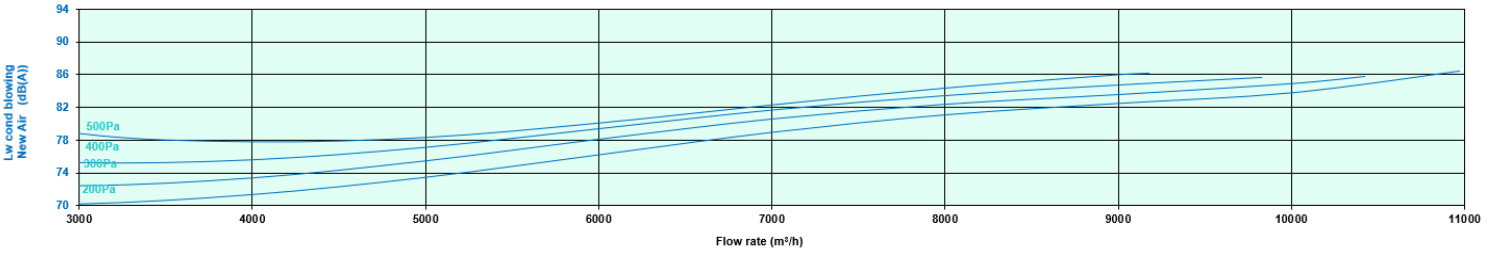
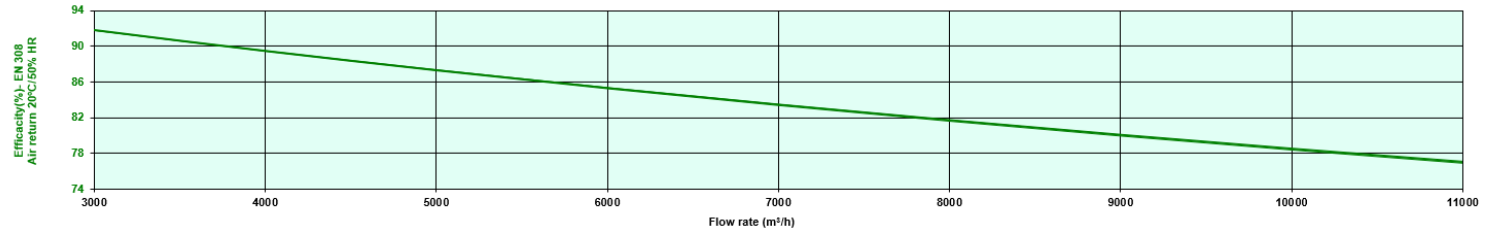
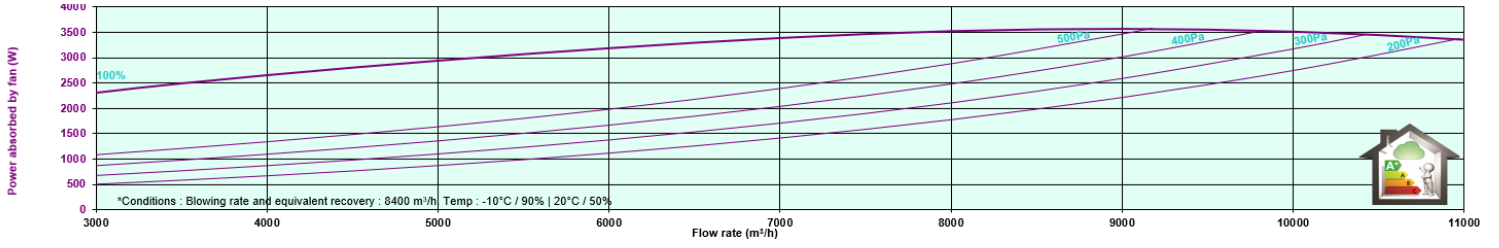
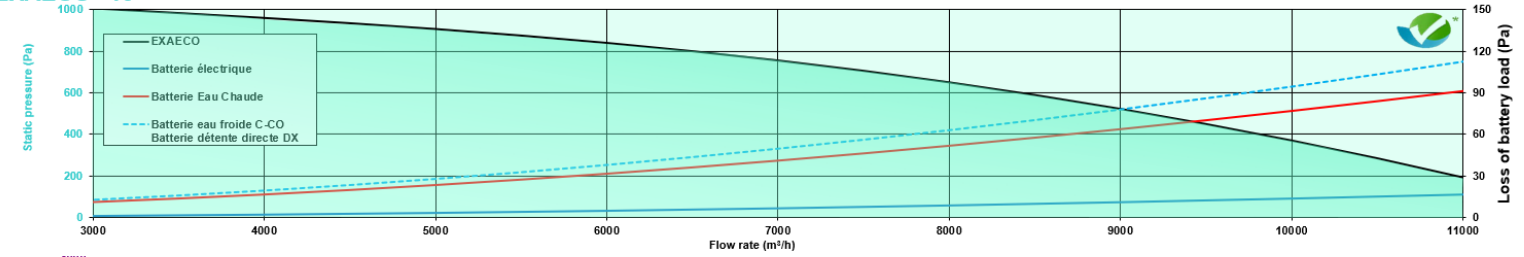

PERFORMANCE CHARACTERISTICS  
OF EXAECO 10  
HEAT BATTERIES

EXAECO®



**H (ELITE)**

Hot water battery

Water temp. (°C/°C)	Air inlet temp. (°C)	Air flow (m³/h)	2000	4000	6000	8000	10000
<b>90/70</b>	11	Power (kW)/Air out T. (°C)	47,1/81,3	83,5/73,4	113/67,4	138/62,7	160/58,9
		Water flow (L/h)/DP water (kPa)	2080/3	3680/7	4990/10	6100/13	7060/17
	15	Power (kW)/Air out T. (°C)	44,5/81,5	78,8/73,8	107/68,1	130/63,7	151/60,1
		Water flow (L/h)/DP water (kPa)	1960/3	3470/6	4700/9	5740/12	6650/15
<b>80/60</b>	11	Power (kW)/Air out T. (°C)	40,5/71,4	71,3/64,2	96,4/59	117/54,9	136/51,5
		Water flow (L/h)/DP water (kPa)	1780/3	3130/5	4230/8	5160/11	5970/13
	15	Power (kW)/Air out T. (°C)	37,9/71,5	66,5/64,7	89,7/59,6	109/55,8	126/52,7
		Water flow (L/h)/DP water (kPa)	1660/2	2920/5	3940/8	4800/10	5550/13
<b>60/50</b>	11	Power (kW)/Air out T. (°C)	29,5/55,1	52,6/50,3	71,5/46,6	87,6/43,7	102/41,3
		Water flow (L/h)/DP water (kPa)	2580/5	4590/10	6250/15	7650/21	8870/28
	15	Power (kW)/Air out T. (°C)	26,9/55,2	47,9/50,7	65/47,3	79,5/44,7	92,1/42,5
		Water flow (L/h)/DP water (kPa)	2350/5	4180/8	5680/12	6940/18	8050/23
<b>45/40</b>	11	Power (kW)/Air out T. (°C)	20,4/41,4	36,2/38,1	49,2/35,5	60,2/33,5	69,8/31,8
		Water flow (L/h)/DP water (kPa)	3540/5	6300/10	8550/15	10500/21	12100/28
	15	Power (kW)/Air out T. (°C)	17,8/41,6	31,5/38,5	42,7/36,2	52,1/34,5	60,4/33
		Water flow (L/h)/DP water (kPa)	3090/4	5470/9	7420/13	9060/16	10500/21

**C-CO (ELITE)**

Cold and changeover battery

Water temp. (°C/°C)	Inlet T air (°C-%HR)	Air flow (m³/h)	2000	4000	6000	8000	10000
<b>7/12</b>	32/40	Power (kW)/Air out T. (°C-%HR)	21,4/10,5-98,2	37/12,7-94,7	49,6/14,2-91,6	60,2/15,3-89	69,3/16,2-86,8
		Water flow (L/h)/DP water (kPa)	3660/4	6340/5	8500/8	10300/10	11900/12
	27/50	Power (kW)/Air out T. (°C-%HR)	16,6/10,6-98,7	28,3/12,3-96,2	37,6/13,5-93,9	45,3/14,5-91,9	51,9/15,2-90,2
		Water flow (L/h)/DP water (kPa)	2840/2	4850/4	6440/5	7760/7	8910/9
	25/50	Power (kW)/Air out T. (°C-%HR)	12,9/10,7-98,7	21,7/12,2-96,3	28,5/13,3-94,1	34,1/14-92,2	38,9/14,6-90,5
		Water flow (L/h)/DP water (kPa)	2220/3	3710/4	4890/4	5850/4	6670/5
<b>6/11</b>	32/40	Power (kW)/Air out T. (°C-%HR)	22,9/9,5-98,1	39,8/11,8-94,6	53,5/13,4-91,4	65,1/14,6-88,8	75,1/15,6-86,6
		Water flow (L/h)/DP water (kPa)	3920/4	6830/5	9170/9	11200/11	12900 /14
	27/50	Power (kW)/Air out T. (°C-%HR)	18,1/9,6-98,6	31,1/11,5-96,1	41,6/12,8-93,7	50,3/13,7-91,7	57,8/14,5 -90
		Water flow (L/h)/DP water (kPa)	3110/3	5340/5	7120/6	8620/8	9910/9
	25/50	Power (kW)/Air out T. (°C-%HR)	14,5/9,7-98,7	24,6/11,3-96,2	32,5/12,5-94	39,2/13,3-92	44,8/14-90,3
		Water flow (L/h)/DP water (kPa)	2490/3	4220/3	5580/5	6710/5	7690/7
<b>45/40</b>	11	Power (kW)/Air out T. (°C)	20,7/41,9	37,3/38,8	51,1/36,4	62,9/34,5	73,3/32,9
		Water flow (L/h)/DP water (kPa)	3600/3	6480/3	8880/4	10900/6	12700/8
	15	Power (kW)/Air out T. (°C)	18,1/42	32,4/39,2	44,2/37	54,4/35,3	63,3/33,9
		Water flow (L/h) DP water (kPa)	3140/2	5630/3	7690/5	9450/5	11000/6

**DX-DXR with R410A (ELITE)**

Cold direct expansion battery alone and reversible

Evap. Temp. (°C)	Inlet T air (°C-%HR)	Air flow (m³/h)	2000	4000	6000	8000	10000
<b>7</b>	32/40	Power (kW)	21,4	37,2	49,8	60,4	69,4
		Air out temp. (°C-%HR)	11-93,1	13,2-88	14,8-84,7	16-82,2	17-80,3
	27/50	Power (kW)	17,3	30	40,1	48,6	55,9
		Air out temp. (°C-%HR)	10,4-94,9	12,3-91,1	13,6-88,5	14,5-86,6	15,3-85
	25/50	Power (kW)	14,2	24,6	32,8	39,8	45,5
		Air out temp. (°C-%HR)	10,2-95,1	11,8-91,4	12,9-88,8	13,7-86,9	14,4-85,4
<b>5</b>	32/40	Power (kW)	23,9	41,7	55,9	67,7	77,4
		Air out temp. (°C-%HR)	9,3-92,6	11,9-87,5	13,6-84,1	15-81,7	16,1-79,8
	27/50	Power (kW)	19,8	34,4	46,3	55,9	64,1
		Air out temp. (°C-%HR)	8,8-94,6	10,9-90,7	12,3-88	13,4-86,1	14,3-84,6
	25/50	Power (kW)	16,8	29,1	38,9	47,1	54
		Air out temp. (°C-%HR)	8,4-94,8	10,3-90,9	11,6-88,3	12,6-86,4	13,4-84,9
<b>40</b>	11	Power (kW)	17,5	31,8	44	54,7	64,2
		Air out temp. (°C)	37,2	34,7	32,9	31,4	30,2
	15	Power (kW)	15,1	27,3	37,8	46,9	55,1
		Air out temp. (°C)	37,5	35,4	33,8	32,5	31,5

Condensing temp. (°C)

**EXAECO® 13**

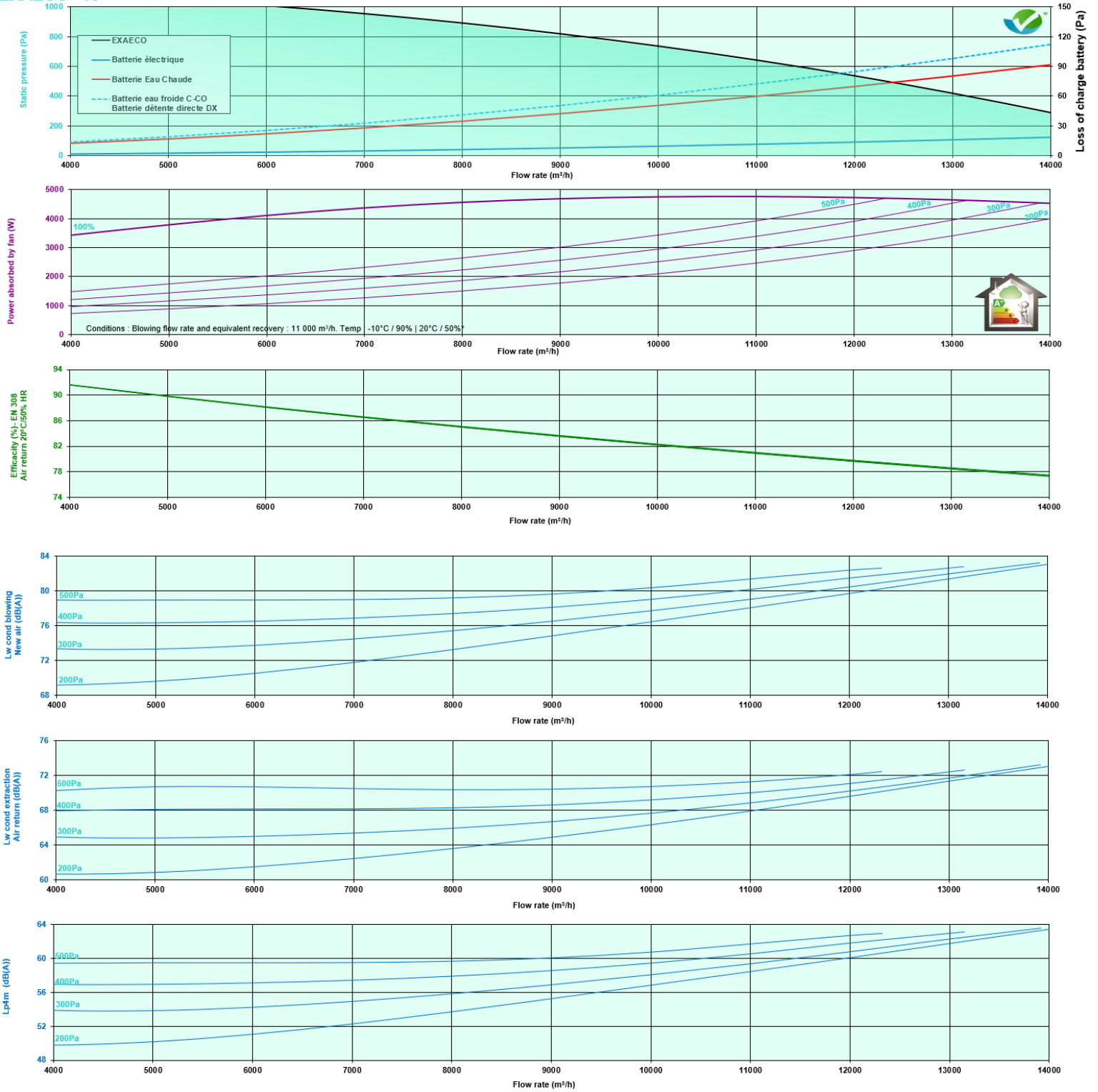

Air flow (m3/h)

# PERFORMANCE CHARACTERISTICS OF EXAECO 13HEAT BATTERIES

# EXAECO®



## H (ELITE)

### Hot water battery

Water temp. (°C/°C)	Air inlet temp. (°C)	Air flow (m³/h)	3000	5000	7000	9000	11000	13000
<b>90/70</b>	11	Power (kW)/Air out T. (°C)	69,4/80,1	105/74	136/69,1	163/65,1	187/61,7	207/58,9
		Water flow (L/h)/DP water (kPa)	3060/5	4650/9	6000/13	7190/17	8240/22	9190/27
	15	Power (kW)/Air out T. (°C)	65,6/80,2	99,5/74,4	128/69,7	154/66	176/62,8	196/60,1
		Water flow (L/h)/DP water (kPa)	2890/5	4380/8	5660/11	6770/16	7760/20	8650/24
<b>80/60</b>	11	Power (kW)/Air out T. (°C)	59,6/70,3	90,2/64,9	116/60,5	139/57	159/54,1	177/51,7
		Water flow (L/h)/DP water (kPa)	2620/5	3960/8	5100/11	6100/13	6980/17	7780/21
	15	Power (kW)/Air out T. (°C)	55,8/70,5	84,2/65,3	108/61,2	129/57,9	148/55,2	165/52,8
		Water flow (L/h)/DP water (kPa)	2450/5	3700/7	4760/10	5680/12	6500/15	7230/18
<b>60/50</b>	11	Power (kW)/Air out T. (°C)	43,5/54,3	66,4/50,6	85,9/47,6	103/45,2	118/43,1	132/41,3
		Water flow (L/h)/DP water (kPa)	3800/8	5800/13	7510/20	9010/28	10300/34	11500/42
	15	Power (kW)/Air out T. (°C)	39,7/54,5	60,4/51,1	78,2/48,3	93,6/46,1	107/44,2	120/42,5
		Water flow (L/h)/DP water (kPa)	3470/7	5280/12	6830/17	8180/24	9380/30	10500/35
<b>45/40</b>	11	Power (kW)/Air out T. (°C)	30,1/40,9	45,8/38,3	59,2/36,3	71/34,6	81,4/33,1	90,9/31,9
		Water flow (L/h)/DP water (kPa)	5220/8	7950/13	10300/20	12300/28	14200/35	15800/42
	15	Power (kW)/Air out T. (°C)	26,2/41,1	39,8/38,8	51,4/36,9	61,6/35,4	70,6/34,2	78,6/33,1
		Water flow (L/h)/DP water (kPa)	4560/6	6930/11	8950/16	10700/22	12300/28	13700/32

## C-CO (ELITE)

### Cold and changeover battery

Water temp. (°C/°C)	Inlet T air (°C-%HR)	Air flow (m³/h)	3000	5000	7000	9000	11000	13000
<b>7/12</b>	32/40	Power (kW)/Air out T. (°C-%HR)	31,7/10,7-97,5	47,4/12,3-94,8	60,7/13,6-92,3	72,3/14,6-90,1	82,6/15,4-88,2	91,9/16,1-86,5
		Water flow (L/h)/DP water (kPa)	5430/5	8140/7	10400/9	12400/12	14200/16	15800/18
	27/50	Power (kW)/Air out T. (°C-%HR)	24,6/10,7-98,2	36,5/12,1-96,2	46,4/13-94,4	55/13,8-92,7	62,5/14,5-91,3	69,3/15-90
		Water flow (L/h)/DP water (kPa)	4220/3	6260/4	7960/6	9440/9	10700/9	11900/11
<b>6/11</b>	25/50	Power (kW)/Air out T. (°C-%HR)	19,3/10,8-98,3	28,2/12-96,4	35,6/12,8-94,6	41,9/13,5-93	47,5/14-91,6	52,5/14,5-90,3
		Water flow (L/h)/DP water (kPa)	3310/3	4830/4	6100/4	7190/5	8150/7	9000/8
	32/40	Power (kW)/Air out T. (°C-%HR)	33,9/9,8-97,4	51/11,5-94,7	65,5/12,8-92,1	78/13,8-89,9	89,2/14,7-88	99,3/15,4-86,3
		Water flow (L/h)/DP water (kPa)	5810/4	8730/8	11200/10	13400/14	15300/18	17000/20
	27/50	Power (kW)/Air out T. (°C-%HR)	26,9/9,7-98,2	40,1/11,2-96,1	51,2/12,2-94,2	60,8/13,1-92,5	69,3/13,8-91,1	76,9/14,4-89,8
		Water flow (L/h)/DP water (kPa)	4620/4	6870/5	8770/8	10400/9	11900/11	13200/14
<b>45/40</b>	25/50	Power (kW)/Air out T. (°C-%HR)	21,6/9,8-98,3	31,9/11-96,3	40,5/12-94,4	47,8/12,7-92,8	54,2/13,3-91,4	60/13,8-90,1
		Water flow (L/h)/DP water (kPa)	3710/4	5470/5	6940/5	8190/7	9300/9	10300/9
	11	Power (kW)/Air out T. (°C)	30,6/41,5	47,1/39,1	61,3/37,2	74/35,5	85,3/34,1	95,5/32,9
		Water flow (L/h)/DP water (kPa)	5320/3	8190/3	10700/5	12900/7	14800/8	16600/10
	15	Power (kW)/Air out T. (°C)	26,7/41,6	40,9/39,4	53,2/37,7	64/36,2	73,8/35	82,5/34
		Water flow (L/h)/DP water (kPa)	4630/3	7110/4	9250/4	11100/6	12800/7	14300/8

## DX-DXR with R410A (ELITE)

### Cold direct expansion battery alone and reversible

Evap. Temp. (°C)	Inlet T air (°C-%HR)	Air flow (m³/h)	3000	5000	7000	9000	11000	13000
<b>7</b>	32/40	Power (kW)	31,3	46,6	59,4	69,8	79,2	87,2
		Air out temp. (°C-%HR)	11,4-92	13,2-88,2	14,5-85,5	15,6-83,4	16,5-81,7	17,2-80,3
	27/50	Power (kW)	25,4	37,7	48	56,6	64,1	70,8
		Air out temp. (°C-%HR)	10,8-94,1	12,2-91,2	13,3-89,1	14,2-87,5	14,9-86,1	15,4-85
	25/50	Power (kW)	20,9	31,1	39,6	46,8	53	58,3
		Air out temp. (°C-%HR)	10,4-94,3	11,7-91,5	12,6-89,4	13,3-87,7	14-86,4	14,5-85,3
<b>5</b>	32/40	Power (kW)	35	52,1	66,2	77,9	88,1	96,6
		Air out temp. (°C-%HR)	9,8-91,5	11,8-87,7	13,4-85	14,6-82,9	15,6-81,2	16,4-79,9
	27/50	Power (kW)	29	43,1	54,9	64,9	73,2	80,6
		Air out temp. (°C-%HR)	9,2-93,8	10,8-90,8	12,1-88,7	13-87	13,9-85,7	14,6-84,6
	25/50	Power (kW)	24,6	36,5	46,6	54,9	62,4	68,7
		Air out temp. (°C-%HR)	8,8-94	10,3-91,1	11,3-89	12,2-87,3	12,9-86	13,5-84,8
<b>40</b>	11	Power (kW)	25,9	40	52,5	63,7	74	83,4
		Air out temp. (°C)	36,8	34,9	33,4	32,1	31,1	30,2
	15	Power (kW)	22,3	34,4	45,1	54,8	63,5	71,6
		Air out temp. (°C)	37,2	35,6	34,3	33,2	32,2	31,5

Condensing temp. (°C)

**EXAECO® 17**

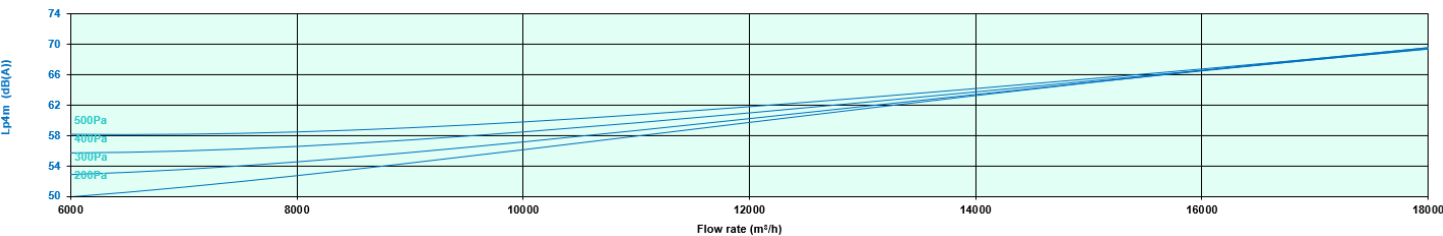
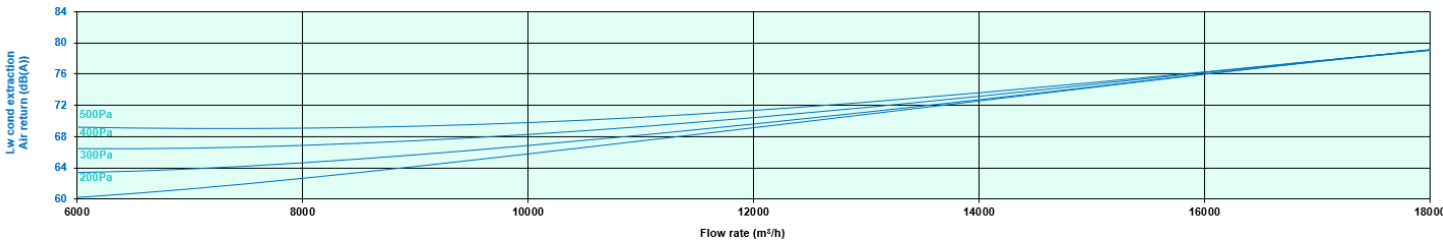
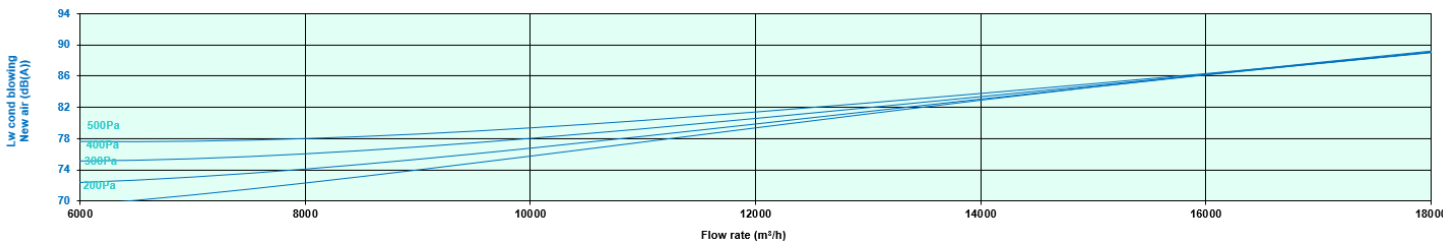
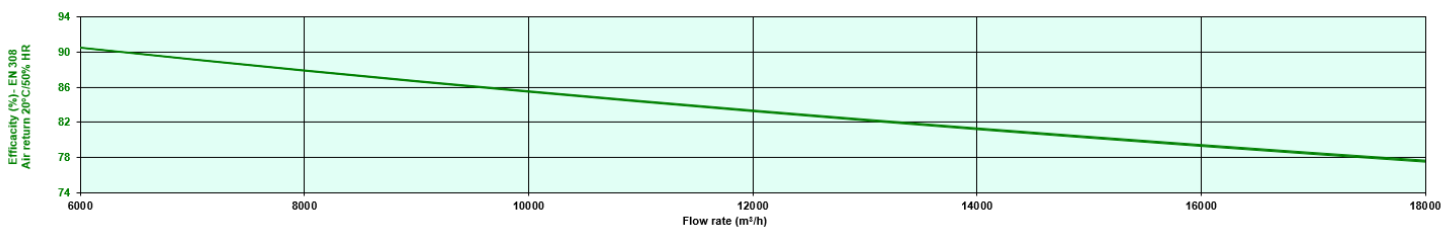
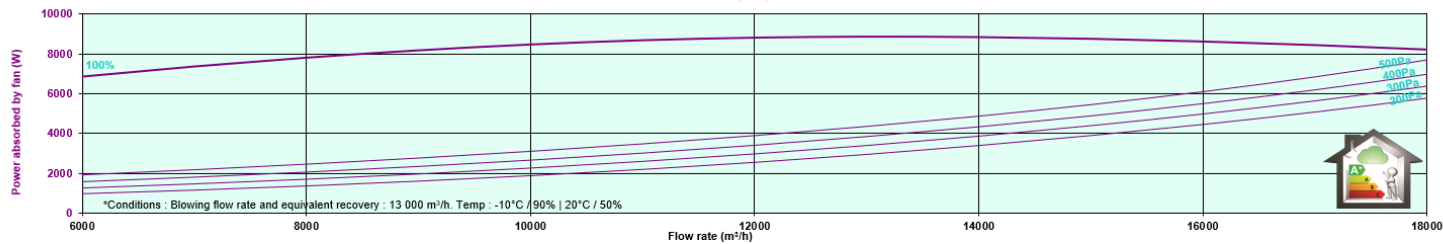
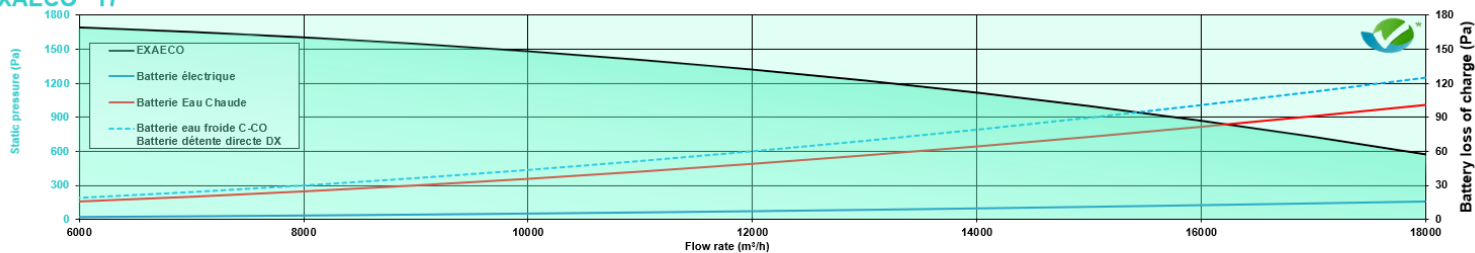

Air flow (m<sup>3</sup>/h)



# PERFORMANCE CHARACTERISTICS OF EXAECO 17 HEAT BATTERY

# EXAECO®



## H (ELITE)

Electric battery

Water temp. (°C/°C)	Air inlet temp. (°C)	Air flow (m³/h)	5000	8000	11000	14000	17000
<b>90/70</b>	11	Power (kW)/Air out T. (°C)	109/75,9	157/69,4	197/64,4	231/60,4	262/57
		Water flow (L/h)/DP water (kPa)	4790/5	6900/6	8670/10	10200/12	11600/15
<b>80/60</b>	15	Power (kW)/Air out T. (°C)	103/76,2	147/70,1	185/65,3	218/61,4	246/58,3
		Water flow (L/h)/DP water (kPa)	4520/4	6500/6	8160/9	9600/12	10900/13
<b>60/50</b>	11	Power (kW)/Air out T. (°C)	92,9/66,5	133/60,7	167/56,3	196/52,8	222/49,9
		Water flow (L/h)/DP water (kPa)	4080/3	5850/5	7340/7	8610/10	9740/13
<b>45/40</b>	15	Power (kW)/Air out T. (°C)	86,7/66,8	124/61,3	155/57,2	182/53,9	206/51,2
		Water flow (L/h)/DP water (kPa)	3810/4	5450/6	6820/7	8010/9	9040/11
<b>60/50</b>	11	Power (kW)/Air out T. (°C)	68,3/51,8	98,7/47,9	124/77,8	146/42,2	166/40,2
		Water flow (L/h)/DP water (kPa)	5970/5	8630/10	10900/14	12800/19	14500/24
<b>45/40</b>	15	Power (kW)/Air out T. (°C)	62,2/52,2	89,7/48,5	113/45,6	133/43,3	151/41,1
		Water flow (L/h)/DP water (kPa)	5440/6	7840/9	9860/12	11600/16	13200/20
<b>60/50</b>	11	Power (kW)/Air out T. (°C)	47,1/39,1	68/36,4	85,5/34,2	101/32,5	114/31
		Water flow (L/h)/DP water (kPa)	8190/5	11800/10	14900/14	17500/14	19800/24
<b>45/40</b>	15	Power (kW)/Air out T. (°C)	41/39,5	58,9/37	74/35,1	87,1/33,6	98,5/32,3
		Water flow (L/h)/DP water (kPa)	7130/5	10200/8	12900/12	15100/15	17100/18

## C-CO (ELITE)

Cold and changeover battery

Water temp. (°C/°C)	Inlet T air (°C-%HR)	Air flow (m³/h)	5000	8000	11000	14000	17000
<b>7/12</b>	32/40	Power (kW)/Air out T. (°C-%HR)	50,7/11,4-96	72,5/13,1-92,7	90,7/14,3-90	106/15,3-87,7	120/16,2-85,7
		Water flow (L/h)/DP water (kPa)	8690/8	12400/13	15600/18	18300/24	20600/30
<b>6/11</b>	27/50	Power (kW)/Air out T. (°C-%HR)	39,4/11,2-97,1	55,8/12,6-94,7	69,5/13,6-92,6	81,2/14,4-90,8	91,5/15-89,3
		Water flow (L/h)/DP water (kPa)	6750/5	9570/10	11900/12	13900/16	15700/18
<b>45/40</b>	25/50	Power (kW)/Air out T. (°C-%HR)	30,9/11,2-97,2	43,2/12,4-94,9	53,4/13,3-92,9	62,1/13,9-91,2	69,7/14,5-89,6
		Water flow (L/h)/DP water (kPa)	5290/5	7410/6	9160/9	10700/10	12000/23
<b>6/11</b>	32/40	Power (kW)/Air out T. (°C-%HR)	54,2/10,5-95,8	77,8/12,3-92,6	97,7/13,6-89,8	115/14,7-87,4	130/15,5-85,4
		Water flow (L/h)/DP water (kPa)	9290/9	13300 /15	16700/21	19700/28	22300/33
<b>45/40</b>	27/50	Power (kW)/Air out T. (°C-%HR)	43,1/10,3-97	61,2/11,8-94,6	76,4/12,8-92,4	89,5/13,7-90,7	101/14,4-89,1
		Water flow (L/h)/DP water (kPa)	7380/6	10500/10	13100/14	15400/19	17300/22
<b>6/11</b>	25/50	Power (kW)/Air out T. (°C-%HR)	34,6/10,3-97,1	48,8/11,5-94,8	60,6/12,5-92,7	70,6/13,2-91	79,4/13,8-89,4
		Water flow (L/h)/DP water (kPa)	5930/4	8370/7	10400/9	12100/12	13600/15
<b>45/40</b>	11	Power (kW)/Air out T. (°C)	49,1/40,3	71,7/37,8	91,1/35,7	108/34	123/32,6
		Water flow (L/h)/DP water (kPa)	8530/4	12500/7	15800/9	18800/13	21400/16
<b>45/40</b>	15	Power (kW)/Air out T. (°C)	42,8/40,5	62,3/38,3	79/36,4	93,6 /35	106/33,7
		Water flow (L/h)/DP water (kPa)	7430/4	10800/6	13700/7	16300/10	18500/12

## DX-DXR with R410A (ELITE)

Cold direct expansion battery alone and reversible

Evap. Temp. (°C)	Inlet T air (°C-%HR)	Air flow (m³/h)	5000	8000	11000	14000	17000
<b>7</b>	32/40	Power (kW)	48,9	69,9	87,5	102	115
		Air out temp. (°C-%HR)	12,5-89,7	14,2-85,9	15,4-83,2	16,4-81,1	17,2-79,5
	27/50	Power (kW)	39,3	56	70	81,9	92,6
		Air out temp. (°C-%HR)	11,7-92,4	13,1-89,5	14,1-87,3	14,9-85,7	15,5-84,3
<b>5</b>	25/50	Power (kW)	32,2	45,8	57	66,9	75,2
		Air out temp. (°C-%HR)	11,3-92,6	12,5-89,9	13,4-87,7	14-86	14,6-84,7
<b>40</b>	32/40	Power (kW)	54,9	78,4	98,5	115	129
		Air out temp. (°C-%HR)	10,9-89,2	12,9-85,3	14,2-82,6	15,4-80,6	16,3-78,9
	27/50	Power (kW)	45,4	64,6	80,9	95	107
		Air out temp. (°C-%HR)	10,1-92	11,7-89	12,9-86,9	13,8-85,2	14,5-83,9
<b>40</b>	25/50	Power (kW)	38,1	54,4	67,9	79,6	90
		Air out temp. (°C-%HR)	9,7-92,2	11,1-89,3	12,1-87,2	12,9-85,5	13,6-84,2
<b>40</b>	11	Power (kW)	41,1	60,4	77,3	92,3	106
		Air out temp. (°C)	35,6	33,6	32	30,7	29,6
<b>40</b>	15	Power (kW)	35,4	51,9	66,4	79,2	90,8
		Air out temp. (°C)	36,1	34,4	33	31,9	30,9



EXAECO® 22

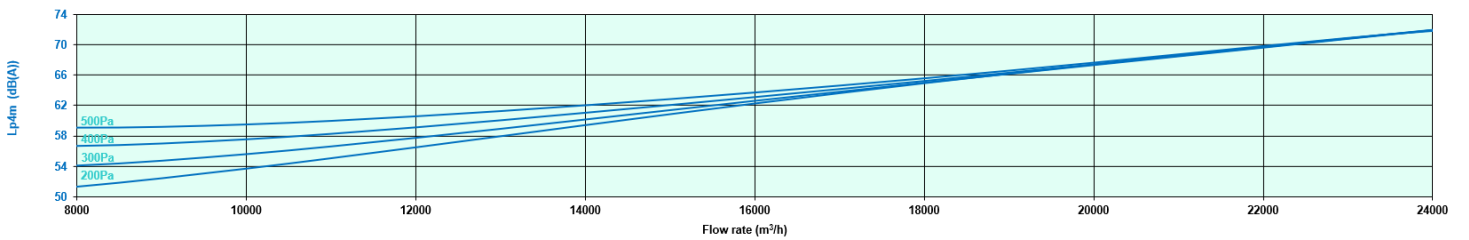
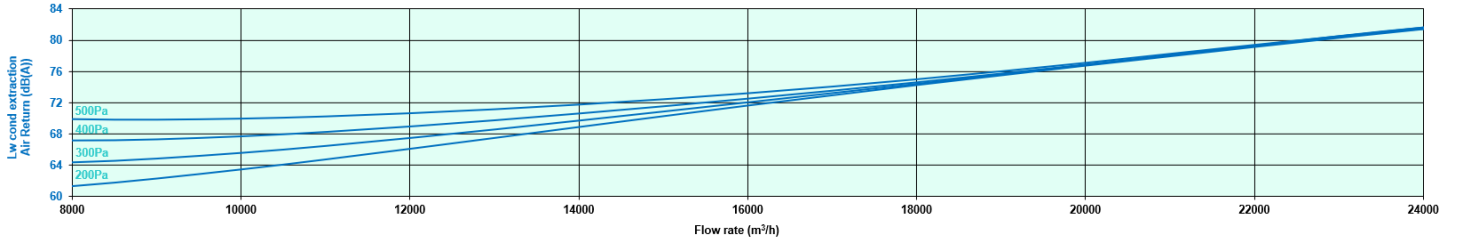
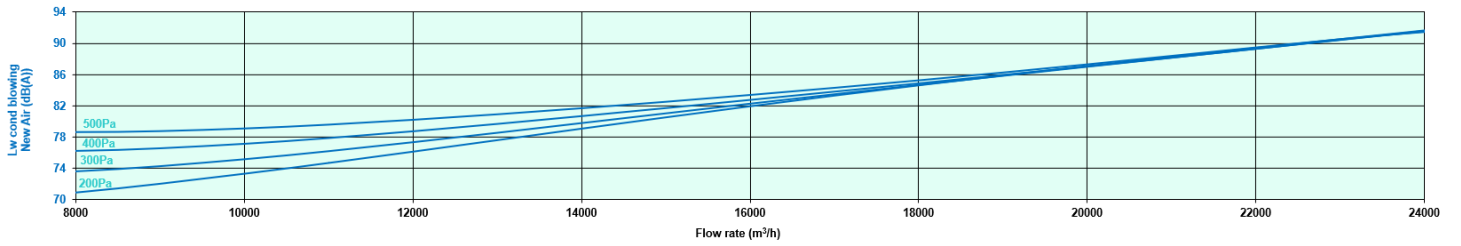
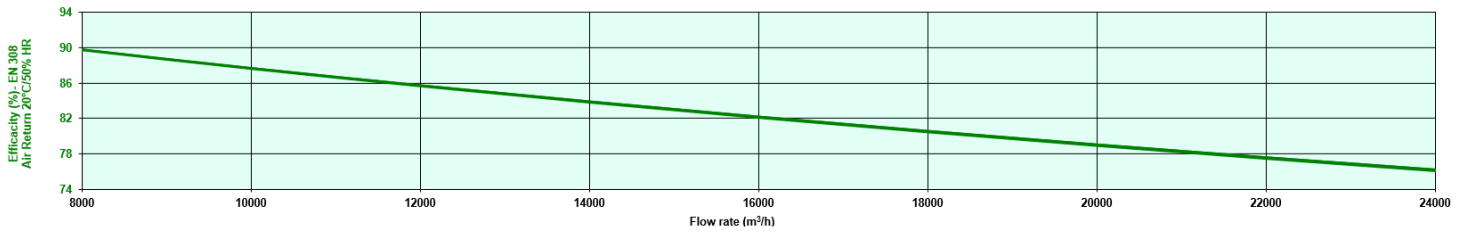
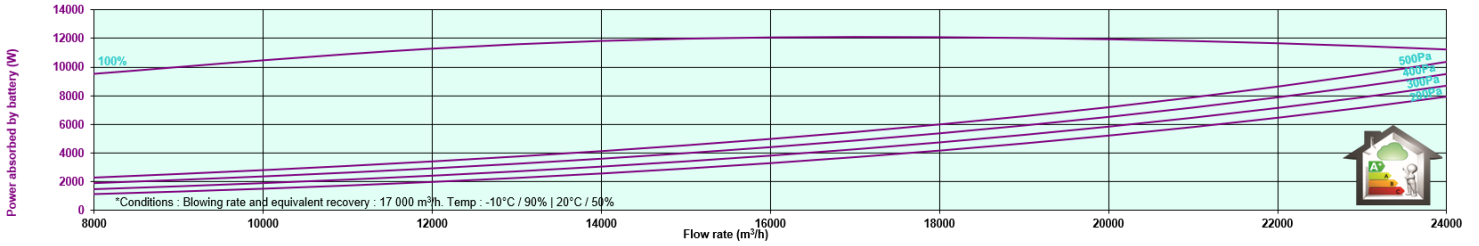
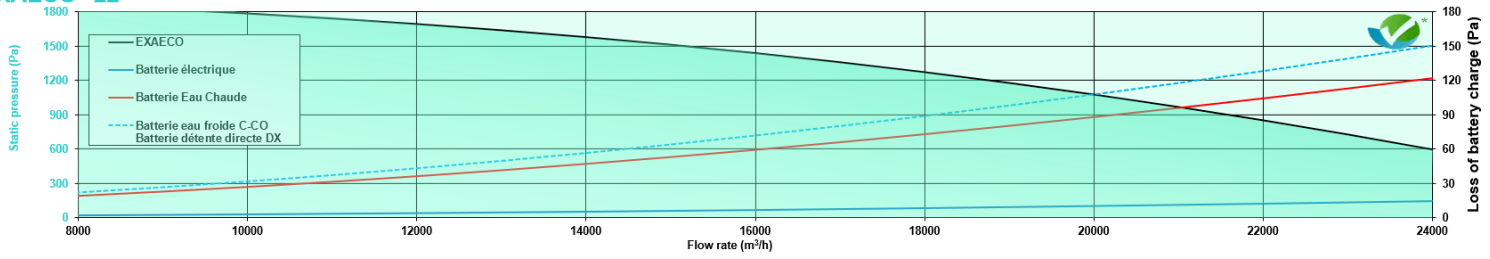

Air flow (m3/h)

# PERFORMANCE CHARACTERISTICS OF EXAECO 22 HEAT BATTERY

# EXAECO®



## H (ELITE)

## Electric battery

Water Air inlet temp. temp. (°C/°C) (°C)		Air flow (m³/h)	6000	10000	14000	18000	22000
<b>90/70</b>	11	Power (kW)/Air out T. (°C)	131/76,2	195/69,1	247/63,7	292/59,5	332/56
		Water flow (l/h)/DP water (kPa)	5770/4	8570/9	10900/12	12900/17	14600/21
<b>15</b>	11	Power (kW)/Air out T. (°C)	124/76,5	183/69,8	233/64,6	275/60,6	312/57,3
		Water flow (l/h)/DP water (kPa)	5450/5	8080/8	10300/11	12100/15	13700/19
<b>80/60</b>	11	Power (kW)/Air out T. (°C)	112/66,8	166/60,5	210/55,8	248/52,1	281/49,1
		Water flow (l/h)/DP water (kPa)	4920/5	7280/7	9220/11	10900/13	12300/16
<b>15</b>	11	Power (kW)/Air out T. (°C)	105/67,1	154/61,1	195/56,7	230/53,2	261/50,4
		Water flow (l/h)/DP water (kPa)	4590/4	6780/6	8580/9	10100/11	11500/14
<b>60/50</b>	11	Power (kW)/Air out T. (°C)	82,3/52	123/47,7	156/44,3	185/41,7	210/39,5
		Water flow (l/h)/DP water (kPa)	7190/7	10700/13	13700/20	16200/26	18400/32
<b>15</b>	11	Power (kW)/Air out T. (°C)	75/52,3	112/48,3	142/45,3	168/42,8	191/40,9
		Water flow (l/h)/DP water (kPa)	6550/6	9750/11	12400/17	14700/22	16700/27
<b>45/40</b>	11	Power (kW)/Air out T. (°C)	56,8/39,3	84,5/36,2	108/33,9	127/32,1	144/30,6
		Water flow (l/h)/DP water (kPa)	9870/7	14700/13	18700/20	22100/26	25100/32
<b>15</b>	11	Power (kW)/Air out T. (°C)	49,4/39,6	73,3/36,9	93,2/34,9	110/33,3	125/31,9
		Water flow (l/h)/DP water (kPa)	8600/5	12700/11	16200/15	19100/21	21700/25

## C-CO (ELITE)

## Cold and changeover battery

Water Inlet T temp. air (°C/°C) (°C-%HR)		Air flow (m³/h)	6000	10000	14000	18000	22000
<b>7/12</b>	32/40	Power(kW)/Air out T.(°C-%HR)	61,4/11,3-96	90,7/13,1-92,4	115/14,4-89,4	136/15,5-87	154/16,4-84,9
		Water flow (l/h)/DP water (kPa)	10500/9	15600/16	19700/25	23200/32	26300/40
<b>27/50</b>	32/40	Power(kW)/Air out T.(°C-%HR)	48/11,1-97,1	70/12,6-94,4	88,2/13,7-92,2	104/14,5-90,3	117/15,2-88,7
		Water flow (l/h)/DP water (kPa)	8230/7	12000/11	15100/17	17800/21	20100/26
<b>25/50</b>	32/40	Power(kW)/Air out T.(°C-%HR)	37,7/11,1-97,2	54,4/12,4-94,7	68,1/13,3-92,5	79,6/14-90,6	89,6/14,6-89
		Water flow (l/h)/DP water (kPa)	6460/4	9330/8	11700/11	13700/14	15400/17
<b>6/11</b>	32/40	Power(kW)/Air out T.(°C-%HR)	65,7/10,4-95,8	97,4/12,3-92,2	124/13,7-89,2	146/14,8-86,7	166/15,8-84,6
		Water flow (l/h)/DP water (kPa)	11300/10	16700/19	21200/29	25100/37	28400/46
<b>27/50</b>	32/40	Power(kW)/Air out T.(°C-%HR)	52,3/10,2-97	76,8/11,8-94,3	97/12,9-92	114/13,8-90,1	129/14,6-88,5
		Water flow (l/h)/DP water (kPa)	8970/8	13200/13	16600 /19	19600/25	22100/30
<b>25/50</b>	32/40	Power(kW)/Air out T.(°C-%HR)	42,2/10,1-97,1	61,4/11,5-94,5	77,1/12,5-92,3	90,2/13,3-90,4	102/13,9-88,8
		Water flow (l/h)/DP water (kPa)	7230/5	10500/9	13200/13	15470/16	17500/20
<b>45/40</b>	11	Power (kW)/Air out T. (°C)	59,1/40,4	89,3/37,7	115/35,5	137/33,7	156/32,2
		Water flow (l/h)/DP water (kPa)	10300/5	15500/8	19900/13	23800/17	27100/21
<b>15</b>	11	Power (kW)/Air out T. (°C)	51,5/40,7	77,6/38,2	99,5/36,2	118/34,6	135/33,3
		Water flow (l/h)/DP water (kPa)	8960/4	13500/8	17300/10	20600/14	23500/16

## DX-DXR with R410A (ELITE)

## Cold direct expansion battery alone and reversible

Evap. Inlet T Temp. air (°C) (°C-%HR)		Air flow (m³/h)	6000	10000	14000	18000	22000
<b>7</b>	32/40	Power (kW)	58,6	85,9	108	127	143
		Air out temp. (°C-%HR)	12,5-89,5	14,4-95,3	15,8-82,4	16,8-80,3	17,7-78,6
<b>27/50</b>	32/40	Power (kW)	47,2	68,7	86,5	101	115
		Air out temp. (°C-%HR)	11,7-92,2	13,3-89	14,4-86,8	15,2-85	15,9-83,6
<b>25/50</b>	32/40	Power (kW)	38,6	56,3	70,8	83,1	93,4
		Air out temp. (°C-%HR)	11,3-92,5	12,6-89,3	13,6-87,1	14,3-85,3	14,9-84
<b>5</b>	32/40	Power (kW)	65,7	96,3	121	142	160
		Air out temp. (°C-%HR)	11-88,9	13,1-84,7	14,7-81,9	15,9-79,7	16,8-78,1
<b>27/50</b>	32/40	Power (kW)	54,1	79,4	100	117	132
		Air out temp. (°C-%HR)	10,2-91,8	12-88,5	13,2-86,3	14,2-84,6	15-83,2
<b>25/50</b>	32/40	Power (kW)	45,7	66,8	84	98,6	111
		Air out temp. (°C-%HR)	9,7-92,1	11,3-88,8	12,4-86,6	13,3-84,9	14-83,5
<b>40</b>	11	Power (kW)	49,2	74,5	96,3	116	133
		Air out temp. (°C)	35,5	33,3	31,5	30,2	29
<b>15</b>	11	Power (kW)	42,3	64	82,7	99,2	114
		Air out temp. (°C)	36	34,1	32,6	31,5	30,5