



Smart and Sustainable Homes

Wiser Underfloor Heating Controller

INSTALLATION

Guide

Please keep this guide for future reference.

- ▶ Controller Heating/Cooling 230V



Phone: 0333 6000 622*

Website: wiser.draytoncontrols.co.uk

E-mail: customer.care@draytoncontrols.co.uk

@DraytonHome

/DraytonHome

*Please note that international call charges may apply to those calling from outside of the UK.

Installer Guide 06490300001 Iss B



01. Wiser Underfloor Heating Controller

Caution!

This device should be installed by a qualified and competent electrician according to the wiring diagram on the product or in this installer guide. Current safety measures should be observed. To achieve the demands of Protection Class II the relevant installation requirements should be applied.

This electronic device is used for controlling thermostats and valves in dry and closed spaces

The following items are needed to install a Wiser Underfloor Heating system:

- ▶ Wiser Underfloor Heating Controllers
- ▶ Wiser Hub*
- ▶ Wiser Room Thermostat
- ▶ Wiser Radiator Thermostat (optionally for mixed system)
- ▶ A smartphone with the installed Wiser Home app

NOTE: The system can be installed without connecting to a wi-fi router, see Point 1g

a) Application (intended use)

The Wiser UFH Controller should only be used with hydronic UFH systems. The device is a part of the Wiser control system. It works in conjunction with the Wiser Hub* and Wiser Room Thermostats, and it controls the temperature in individual rooms/zones.

With mixed systems (UFH and radiators) Wiser Radiator Thermostats can be added and in this way a complete hydronic heating system can be controlled. The system is simple to expand: 2 further Wiser UFH Controller (and optionally Wiser Radiator Thermostats) can be added.

- ▶ 1x UFH max. 6 zones
- ▶ 2x UFH max. 12 zones
- ▶ 3x UFH max. 16 zones



b) Wiser UFH Controller features

- ▶ 230V terminals to power the thermal actuators
- ▶ 6 channels/zones (each controlled by a Wiser Room Thermostat)
- ▶ Up to 14 normally-closed 230V thermal actuators
- ▶ Fuse to protect against any short circuits when connecting the thermal actuators
- ▶ Overload protection against switching all thermal actuators simultaneously (channels are switched one after the other with a delay)
- ▶ Pump protection (if the heating is not used for one week the pump will run briefly).

c) Wiser system features

- ▶ Individual control of up to 16 rooms/zones when using 3 Wiser UFH Controllers
- ▶ Control of mixed hydronic heating systems (radiators and UFH)
- ▶ Individual temperature schedule for each room/zone
- ▶ Manual and away modes
- ▶ Cloud features such as Eco Mode, Geofencing through IFTTT and voice activation with Amazon Alexa and the Google Assistant from anywhere in the world.

As the Wiser system is constantly being upgraded please look for further features on the Wiser website wiser.draytoncontrols.co.uk.

d) Installation

- ▶ The Wiser UFH Controller is installed using the supplied DIN-Rail. It can be clipped on and off using the green clips on the rear.
- ▶ To remove Push the green clip downwards using a screwdriver until it clicks
- ▶ To attached With a screwdriver push the green clip upwards until it clicks

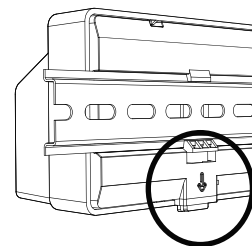

e) Electrical connection

⚠ The system can be tested with or without the app.
Attention: before installation isolate from mains

Open the cover:

Insert a screwdriver and push the cover to the left according to the symbols on the cover. The wiring diagram is shown on the device.

- ▶ Wiring must be carried out by a qualified and competent electrician
- ▶ The UFH Controller is only for fixed wiring
- ▶ For optimum cable retention remove 9mm of cable insulation
- ▶ Only use cables of the specification below
- ▶ All cables must be fully inserted in the connector blocks
- ▶ After wiring please ensure that the cables are:
 - correctly connected
 - fully inserted
 - firmly in position
 - not twisted or under tension

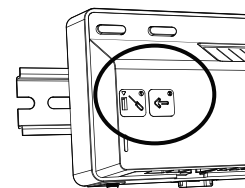

Close the cover:

Press the cover on the rear housing and then push to the right until it clicks.

Minimum cable characteristics:

Thermal actuators and mains supply: 0.75mm², 2-core, flat

Remote sensor: 0.25mm², 1-core (x2), Round

Dew sensor: 0.25mm², 1-core (x2), round

Heating / cooling, pump and boiler: 0.75mm², 2-core, round

NOTE: in larger rooms several UFH zones can be associated with a room thermostat. For example by connecting Channels 1 and 2 up to 8 thermal actuators can be used in one room.

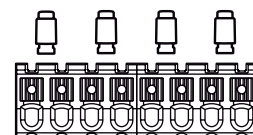

11 12 13 14 15 16 17 18

1. Thermal Actuator relays

Thermal actuators are connected to each zone. Polarity is not important.

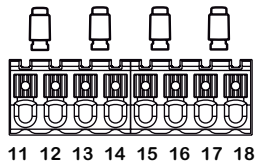

2. Power consumption

To supply the UFH Controller please connect as follows:
230Vac.
Internal 3.15A fuse



3. Pump contact

Connect as indicated below:

NOTE: The pump is activated when any valve is closed. The pump will run for 2 minutes after the last valve closes.

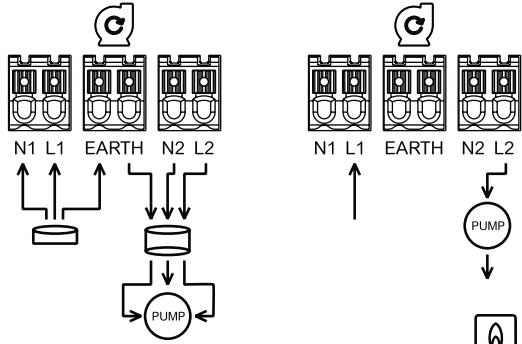

4. Boiler contact

The boiler will be switched off when all valves are closed. The relay is normally open and can be used volt-free (directly to the boiler) or switched live with 230Vac (to a zone valve).

Attention: May still be live even if mains is switched off.

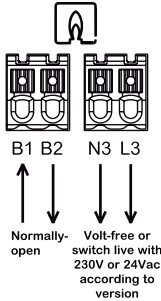

When several (max 3) Wisser UFH Controllers are used, please connect as per the diagram on the right.

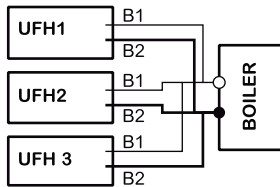

5. Heating/Cooling input

The system will switch to cooling mode when 230V is applied.

Note: when several (max 3) controllers are used only one heating/cooling input is required. The complete system will change to cooling mode.

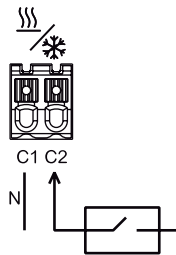

In the Wisser Home app rooms can be excluded from cooling if required (eg bathrooms). Note also that only rooms with UFH will cool when using cooling mode.

Wiring diagram

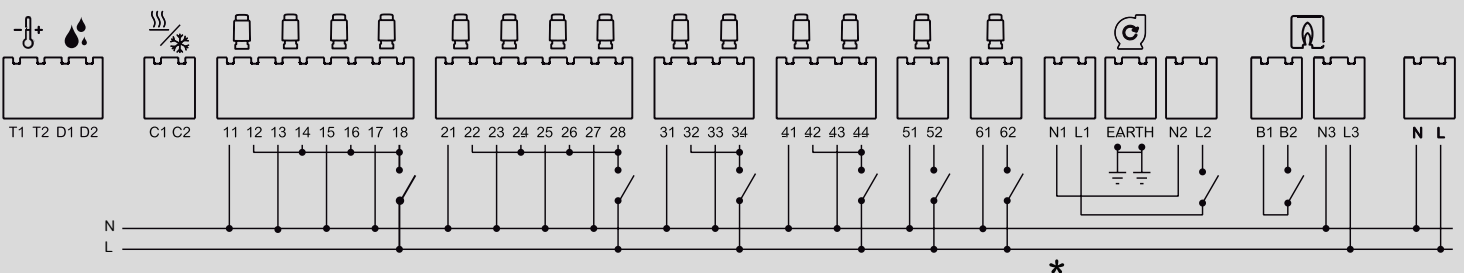

6. Dew sensor and remote sensor inputs

The following sensors should be connected:

Drayton dew sensor 193683

When in cooling mode the dew sensor can detect condensation and turn off the cooling. It can be attached to the manifold.



Drayton remote sensor 193720

The remote floor sensor can be used as a high or low limit to protect the floor. It works on one zone only.



f) External antenna

The supplied antenna must be used to ensure consistent communication with Wisser devices. The antenna is screwed to the connector underneath the Wisser UFH Controller.

To optimise signal strength the antenna should be mounted in a suitable position outside and away from the manifold cabinet (not on the metal frame of the manifold cabinet).

Use of supplied antenna with a third-party extension cable: In many applications an extension cable can be used to optimise the mounting position of the antenna. Please note that in this case the extension cable may reduce the signal, i.e. the signal range may be reduced (see table below).

Length (m)	Recommended type	Possible range loss (dB)
5m Low loss RG54 coaxial cable	SIRETTA ASMA500B058L13 Uk.farnell.com code: 2666850	(3dB) approx. 40% range loss
10m Low loss RG54 coaxial cable	SIRETTA ASMA1000B058L13 Uk.farnell.com code: 2666851	(6dB) approx. 50% range loss

*The estimated range loss applies to the cable types in the above table only. Alternative RG54 coaxial cables may give significantly different performance.

g) Wiring test / emergency operation

Wiring can be tested without connection to the Wisser system. This function can also be used in emergencies to open all or selected valves.

- Press and hold the channel select button ">" for >2 seconds
- Press this button again to select further channels. The selected channel LED will flash.
- When the required channel LED is flashing press and hold ">" for >2 seconds. This LED will be solid green and the next channel LED will flash. You can select any channel combination, e.g. channels 1, 3 and 5.

Channel testing

- Pressing ">" on channel 6 activates the selected channels. The relevant LEDs will flash green and the actuators open to allow water flow.
- After 4 hours the test stops. The test can also be stopped by pressing ">"

If multiple Wisser UFH Controllers are being used this test can be carried out on all controllers.

h) Please use the supplied label to mark the channel names (on the front cover)

If you are installing a system with only underfloor heating (no radiators) you can select in the Wisser Home app to control the boiler using the Wisser UFH Controller boiler output OR the heating output in the Hub*.

02. Adding a Wiser UFH Controller to the system

Adding Wiser UFH Controller and Room Thermostats

To continue the installation for our Wiser UFH Controller and Room Thermostats you will need to download and install the Wiser Home app on your smartphone.

Open the app and select
▶ "set up new system"



The app takes you through the installation and commissioning process. It associates the room thermostats with the appropriate UFH controllers and channels then connects the Hub[®] to your Wi-Fi router (to the internet).

During this process you will be asked to enter your email address and a password. When these are submitted an email will be sent to your email address. To continue registration please confirm the link and return to the app.

NOTE: to use the Wiser Home app you must accept our terms and conditions. There is a link in the app for this.

NOTE: if you do not receive this email please check your junk folder.

Once you have completed these steps and installed the Wiser UFH Controller and room thermostats you can operate your heating system via the Wiser Home app from anywhere.

The temperature of your rooms will now be controlled automatically according to the relevant schedules (these are preprogrammed). These can be adjusted via the app.

NOTE: if you would like to operate your Wiser system with other smartphones, the app needs to be installed and the same email address and password used.

Trademarks

- Apple[®], iTunes[®], App Store[®], iPhone[®], iPod[®], and Mac OS[®] are brand names or registered trademarks of Apple Inc.
- Google Play[™], Google Play Store[™] and Android[™] are brand names or registered trademarks of Google Inc.
- Wi-Fi[®] is registered trademark of the Wi-Fi Alliance.



Drayton
by Schneider Electric

03. Download the Wiser Home app

Commissioning UFH channels and rooms

Preparation:

All necessary Wiser UFH controllers should be connected to the Hub[®]. The select "Add device" under ⚙️ "Settings" and then "Devices"

- In ⚙️ Settings then Devices select the room name.
- In Type of Heating select UFH
- Select the relevant Wiser UFH Controller (there may be up to 3)
- Select the channels which should be associated with this room. Several channels can be selected (even with gaps, e.g. channels 1 and 6) (Please note that channels selected must correspond to the heating loops and actuators controlling these rooms)
- Select Ready

The app can now be tested

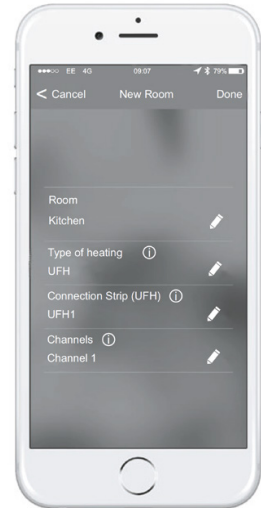

04. User actions and LED behaviour / overview

User action	LED	LED Status	Behaviour
	⏻ LED	Green	Mains power supplied
	Channel 1-6 LED	Off	Relay closed (no call for heat)
	Channel 1-6 LED	Green	Relay closed (call for heat)
	Channel 1-6 LED	Green, dimly lit	Delay on relay activation
	Channel 1-6 LED	Green, flashing	System test / emergency operation
	Setup LED ⚙️	Green	Connected to the Hub [®]
	Setup LED ⚙️	Amber, flashing	Attempting to pair with the Hub [®]
	Setup LED ⚙️	Amber	Not connected to the Hub [®] . To connect see 4.
	Setup LED ⚙️	LED flashing red	Floor temperature exceeded
Emergency operation / wiring test	Selected LEDs	Green, flashing slowly	Channels activated. See 1.g
Connect the UFH Controller with the Hub [®] Press ⚙️ and hold setup button for >2 secs	Setup LED ⚙️	Flashing amber/green	The Wiser UFH is attempting to pair with the Hub [®] . Follow the instructions in the app, see point 3 and 4
Reset the UFH Controller Press ⚙️ and hold setup button for >20 secs	Setup LED ⚙️	Red until all LEDs flash	Reset: the Wiser UFH will be removed from the system
Identify device from the app	All LEDs	All LEDs flash	To identify the Wiser UFH
	Heating/Cooling LED	Solid blue LED	In cooling mode
	Heating/Cooling LED	Flashing blue LED	Dew sensor activated
	Pump LED	Solid Green LED	Pump activated
	Boiler LED	Solid Green LED	Boiler activated

05. Wiser Room Thermostats

Intended use

The Wiser Room Thermostat measures the temperature in the room. The Hub[®] controls room temperature using this information.

NOTE: every room with a UFH channel must have an associated room thermostat.

A room thermostat also displays the current room temperature, the set temperature and the humidity level. The set temperature can be adjusted and a boost set.

The room thermostat receives the set temperature from the Hub[®] and this can be changed in the app. It follows the selected operation (automatic, manual, away, boost). These can be overridden here (in auto mode only until the next period).

06. Adding Wiser Radiator Thermostats

Wiser can be installed and used without internet access:

- ▶ On the app select “set up new system” but skip the last step “Now we will connect the Wiser Hub[®] to your Wi-Fi router”.

Wiser can also control missed systems.

Applications:

- Some rooms are heated by radiators and others by underfloor heating
- In the same room there may be underfloor heating and a radiator. In this case the room will need two room names, one for the radiator and the other for UFH, for example:
 - ▶ Lounge UFH
 - ▶ Lounge Radiator



Follow the instructions in the app to add rooms.

 Settings, then select Devices, then +

07. Removing devices from the system

Devices can be removed in various ways:

- Using by the app:** open the settings menu  the Devices. Search for the relevant device, press >, then “Remove from system”. This is the recommended way to remove devices. **Note:** if a removed device has no connection (e.g. dead batteries) then it must also be removed on the device itself, see below:
- On the Room Thermostat:** replace the dead batteries with new ones. When the green start screen is displayed press and hold the ⊕ and ⊖ buttons for 20 seconds until the screen “Join a network” appears. The Room Thermostat has now been removed from the system and can be added again.

- On the Radiator Thermostat:** turn the cap to ⊖ for >15 seconds until the red LED light flashes 8 times. When the cap is released all LEDs will flash. The valve will then open, the left and right LEDs will flash, and finally the middle LED will be solid amber (for 5 minutes).
- On the Wiser Hub[®]:** press and hold the setup button  for >20 seconds until all LEDs flash. The setup LED  will be amber.
- Reset the Hub[®]:** press the button for >20 seconds until the LED goes out and then goes amber followed by red. Release the button when the LED is red and it will shortly turn green. At this point the device is ready for pairing

NOTE: this will reset all other devices. To use these devices again they must be reset, see points 2, 3 and 4 above. The system can be set up again using the app.

Resetting the Hub[®] does not delete the account. To delete the account please contact Customer Support or set up a new account with a new email address.

08. Identify devices

Using the app  select Settings and then Devices.

- ▶ Click on “>”
- ▶ Click on “identify devices”
 - UFH Controller: All LEDs flash green
 - Room Thermostat: Identify is displayed*
 - Radiator Thermostat: Red, Green and Blue LEDs flash*

* this may take up to 60 seconds

To speed up the process:

Room Thermostat press ⊕ or ⊖
Radiator Thermostat Turn the cap to ⊕ or ⊖

09. Using Wiser without the internet

At home you can connect directly to Wiser. Remote access is then not possible.

10. Installation mode

Wiser can be installed and used without internet connection as follows:

- ▶ On the app select “Set up new system” and just skip the last step “Now we will connect your Wiser system”.

NOTE: your Wiser Hub[®] may not have the latest firmware. If you experience any problems during installation the Hub[®] can update itself over Wi-Fi. To connect the Hub[®] to the Wi-Fi please follow the instructions in the app. The upgrade will occur after a few hours.

11. Technical data

Version	Wiser UFH Controller Heating / Cooling 230V
Part number	WF762F1A0902
Power supply	230 V AC ± 10% 50Hz
Zones and devices per system	Max 6 devices per zone, max 16 zones per system, max 32 devices per system
Ambient temperature	Operating 0°C to 50°C. Storage -10°C to 55°C
Ambient humidity (non condensing)	Operating 25% to 85%. Storage 15% to 85%
Remote sensor temperature resolution	1°C
Without power	Relays normally open
Wireless	2.4GHz (Bi-directional, Mesh)
Signal range	30m Free space
Maximum signal strength	14dBm (25mW)
Dimensions	305 x 90 x 65mm (LxHxD)
Pollution class	2
Energy class	IV=2%
Software class	A
Fuse rating	3.15A approx.
Relays	Normally open 2(1)A
Number of 3W actuators per channel	Zones 1 and 2 – 4 actuators / Zones 3 and 4 – 2 actuators / Zones 5 and 6 – 1 actuator

Number of 3W actuators per device	14	
Rated surge voltage	4kV	
Terminals (green)	*Screwless for type Y 0.08 – 1.5 mm ² , AWG 16-28"	
Protection class	Class II	
Ingress protection	IP30	
Antenna	External antenna (supplied)	
Automatic function	Not applicable: the thermostat controls the temperature	
Method of earthing control	Device not earthed. Double insulated.	The device is not earthed. A terminal is provided for an external earth cable. Double insulated.

These individually installed electronic devices measure temperature in dry and enclosed spaces with normal conditions. The devices conform to EN60730.

12. Fault finding

	Behaviour	Explanation	Solution
Wiser UFH Controller	Orange LED  is flashing	No connection to Hub ^R	Please check: The Hub ^R LED is solid green. Signal strength can be seen in app. The external antenna is connected. The Wiser UFH Controller can be used without the Hub ^R to open and close the valves. See 1.g.
Wiser Hub^R	Red LED is flashing	No connection to the router	Please check: Is the router on and connected to the internet? Have you changed the Wi-Fi password? Do you have a new router? The Wiser UFH Controller will function for 10 minutes and then close all valves. The heating system can be operated in emergency mode.
	Solid red LED	No connection to the cloud	Wait for a short time, or activate installation mode to use the app.
Wise Radiator Thermostat	Middle LED flashes red for 1 sec (every hour)	Weak batteries	Replace batteries. Battery status can also be checked by turning the cap
	Middle LED flashes red for 5 seconds (every 5 minutes)	Very weak batteries	Replace batteries. Battery status can also be checked by turning the cap
	Middle LED, amber flashes (flashes for 5 secs)	After 2 mins if no network is found (the green LED was previously visible)	Repeat pairing
	Middle LED solid amber	Not connected to the Hub ^R	Repeat pairing
	Middle LED, red (slowly fades on/off)	Reset underway	
	Red or blue LEDs flash (after turning cap)	Poor signal strength	Distance to the Hub ^R is too big. Position Hub ^R nearer to devices (but not too far from the router). Or use a Wiser Plug as range extender
	Red and blue LEDs flash (middle LED when green indicates an active connection, amber indicates not active, the device should be paired again)	Ready to mount on the valve	Install device
Wiser Room Thermostat	Red LED flashes 4 times (under the boost button)	No signal	Distance to the Hub ^R is too big. Position Hub ^R nearer to devices (but not too far from the router). Or use a Wiser Plug as range extender
	Red symbol for signal strength	No signal	Distance to the Hub ^R is too big. Position Hub ^R nearer to devices (but not too far from the router). Or use a Wiser Plug as range extender
	Red LED flashes once (under the boost button)	Weak batteries	Replace batteries
Wiser Home App	"searching for Hub ^R " displayed	No connection to the Hub ^R	Is the Hub ^R LED flashing? See above

System Behaviour		
The room temperature does not meet expectation	a. Is the room thermostat correctly positioned?	Place the room thermostat where it can measure room temperature accurately
	b. Are the room thermostat and UFH channel correctly associated?	Using the app under  Settings the Devices ">" check the channels selected for each room thermostat
	c. Is the temperature schedule entered correctly?	Check schedules and association with rooms
	d. Are the devices connected to the Hub ^R ?	See 5"User actions and LED behaviour"
	e. Are there flashing LEDs on any of the devices?	See 5"User actions and LED behaviour"

Hereby Schneider Electric Controls UK Ltd, declares that these products are in compliance with the essential requirements and other provisions of RED 2014/53/EU. Declaration of conformity can be downloaded from: www.draytoncontrols.co.uk

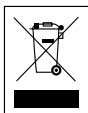

Recycling:
Batteries must not be disposed of in household refuse. They must be disposed of according to guidelines to protect the environment. Batteries can be returned to where they were purchased or taken to recycling centres. This product must not be disposed of in household waste. Please take to facilities for electronic waste. These are published by local authorities under Recycling. The coin-cell batteries on the circuit boards can only be removed at end of life by qualified professionals.

Schneider Electric Controls Ltd
401 Southway Drive
Plymouth
PL6 6QT

Schneider Electric Industries SAS
35 rue Joseph Monier
F-92500 Rueil-Malmaison
France