

Sentinel

Kinetic MVHR Range

Installation & Commissioning



Stock Ref. N°

438222	Kinetic B Right
438222L	Kinetic B Left
443319	Kinetic BH Right
443319L	Kinetic BH Left
408167	Kinetic FH Right
408169	Kinetic FH Left
443028	Kinetic Plus B Right
443028L	Kinetic Plus B Left
408449	Kinetic High Flow Right
408451	Kinetic High Flow Left

Vent-Axia®

PLEASE RETAIN THESE INSTRUCTIONS WITH THE PRODUCT.



IMPORTANT SAFETY INFORMATION



PLEASE READ THESE INSTRUCTIONS CAREFULLY BEFORE COMMENCING INSTALLATION.

1. Do not install this product in areas where the following may be present or occur:

- Excessive oil or a grease laden atmosphere.
- Corrosive or flammable gases, liquids or vapours.
- Subject to direct water spray from hoses.
- Ambient temperatures higher than 40°C and lower than -20°C.
- Possible obstructions that may hinder access to or removal of the unit.

2. All wiring must be in accordance with the current IEE wiring regulations BS7671, or appropriate standards of your country. Installation should be inspected and tested by a suitably qualified person after completion.

3. Ensure the mains supply (voltage, frequency and phase) complies with the rating label.

4. The unit should be provided with a local double pole fused spur fitted with a 3A fuse having a contact separation of at least 3mm.

5. These units must be earthed.

6. Precautions must be taken to avoid the back-flow of gases into the building from the open flue of gas or other fuel-burning appliances.

7. This appliance is not intended for use by persons (including children) with reduced physical, sensory or mental capabilities, or lack of experience and knowledge, unless they have been given supervision or instruction concerning use of the appliance by a person responsible for their safety.

8. Young children should be supervised to ensure that they do not play with the appliance.

INSTALLATION GUIDANCE

1. The installer is responsible for the installation and electrical connection of the sentinel system on site. It is the responsibility of the installer to ensure that the equipment is safely and securely installed and left only when mechanically and electrically safe.

2. All regulations and requirements must be strictly followed to prevent hazards to life and property, both during and after installation, and during any subsequent servicing and maintenance.

3. The unit's condensate drain must be connected to the building's wastewater drainage system.

4. Certain applications may require the installation of sound attenuation to achieve the sound levels required.

5. The unit must not be connected directly to a tumble drier.

6. The supply and exhaust valves must be fully opened prior to commissioning.

7. The supply air must be drawn from the exterior of the property.

8. The unit should be allowed to stabilise during commissioning for a minimum period of 5 minutes when changing between boost and normal speeds.

9. External grilles should be positioned in accordance with your local building regulations, however as a minimum we recommend that the inlet grille is kept 2m from any discharge grille or flue outlet.

10. This product and associated duct installation should be carried out in accordance with the domestic ventilation compliance guide.

Disposal



This product should not be disposed of with household waste. Please recycle where facilities exist. Check with your local authority for recycling advice.

About this Document

Contents

IMPORTANT SAFETY INFORMATION	2
INSTALLATION GUIDANCE	2

Product Description 4

Sentinel Kinetic, Sentinel Kinetic F, Sentinel Kinetic Plus & Sentinel Kinetic High Flow.....	4
---	---

Technical Data 6

Sentinel Kinetic Performance graph for Horizontal Discharge	9
Sentinel Kinetic F Performance graph for Vertical and Horizontal Discharge	10
Sentinel Kinetic Plus Performance graph for Vertical and Horizontal Discharge	11
Sentinel Kinetic High Flow Performance graph for Vertical and Horizontal Discharge	11
Installation	11
Before Installation of the Unit.....	12
Unit Installation.....	12
Electrical Installation.....	20
Powering Up the Unit.....	23
Control Unit Display.....	23
Start-up Screens.....	24

Commissioning 28

Overview	28
Control Unit Screens Summary	29
Commissioning Screens	30

Maintenance 40

Filter Maintenance	40
Periodic Maintenance	40
Spares.....	41

Troubleshooting 42

Diagnosing a Problem	42
----------------------------	----

Appendix One: Control Mode 02 Description 44

Overview	44
Terminal Connections and Functions.....	44
Airflow Mode Selection	45

Appendix Two: Options and Accessories 46

CO2 Sensor.....	46
Normal / Boost Switch	46
Humidistats.....	46
Connecting a System Cooker Hood.....	46
Connecting an Opto-coupler (447340).....	46
Wired Remote Control (443283)	47
Isolator Relay Controller (442030)	47
Remote LED Indicator	48

UK Building Regulations (Part F) Declaration of Conformance

The Sentinel Kinetic conforms to the 2010 Building Regulations (Part F - Means of Ventilation requirements) for installed performance of a ducted mechanical extract fan when installed in accordance with the instructions in this document.

Note:

Read in conjunction with the User Instruction Manual 442073

Product Description

Sentinel Kinetic, Sentinel Kinetic F, Sentinel Kinetic Plus & Sentinel Kinetic High Flow

The Vent-Axia **Sentinel Kinetic, Sentinel Kinetic F, Sentinel Kinetic Plus & Sentinel Kinetic High Flow Mechanical Ventilation/Heat Recovery (MVHR)** are heat recovery units designed for the energy efficient ventilation of houses and similar dwellings, conforming to the latest requirements of the Building Regulations document F 2010.

The units are designed for continuous 24 hour exhaust ventilation of stale moist air from bathrooms, toilets and kitchens. As the stale air is extracted, a heat exchanger within the unit transfers up to 90% of the heat into the supply air entering the bedrooms and lounge.

Units are available with the condensate drain on the right or left hand side.

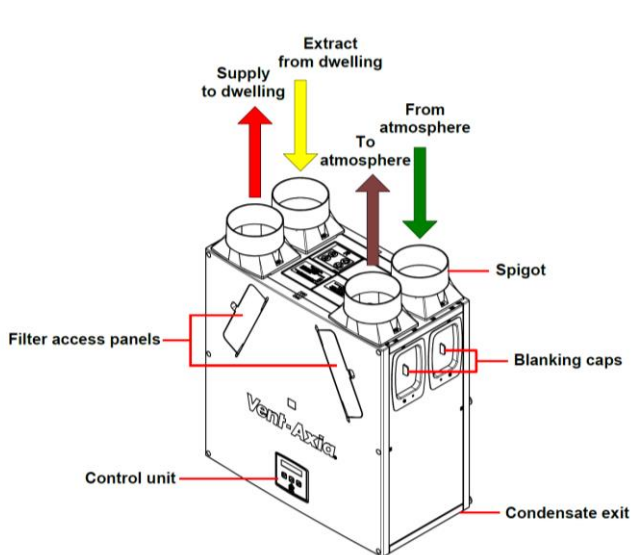

Fig 1: Sentinel Kinetic Right handed

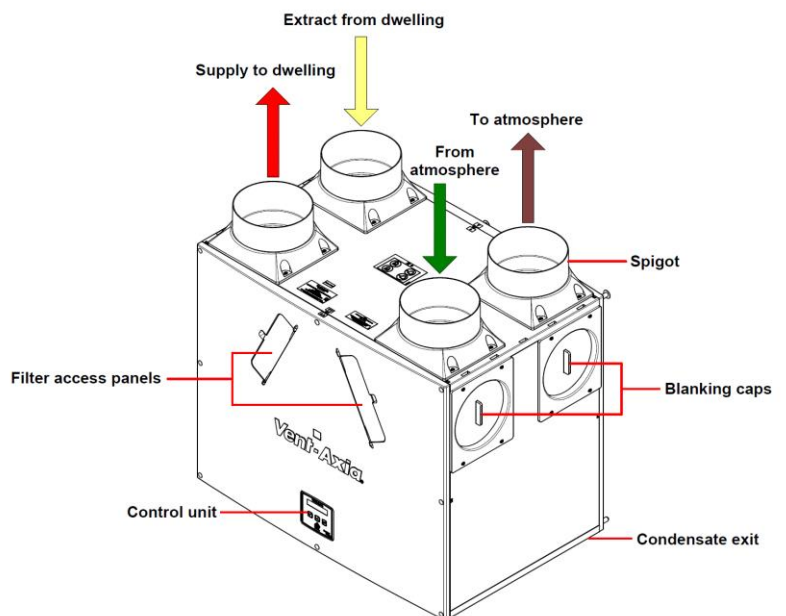

Fig 2: Sentinel Kinetic F, Sentinel Kinetic Plus and High Flow Right handed

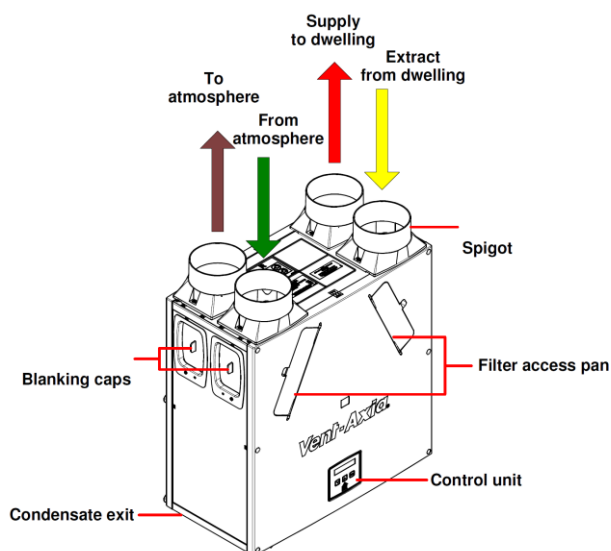

Fig 3: Sentinel Kinetic Left handed

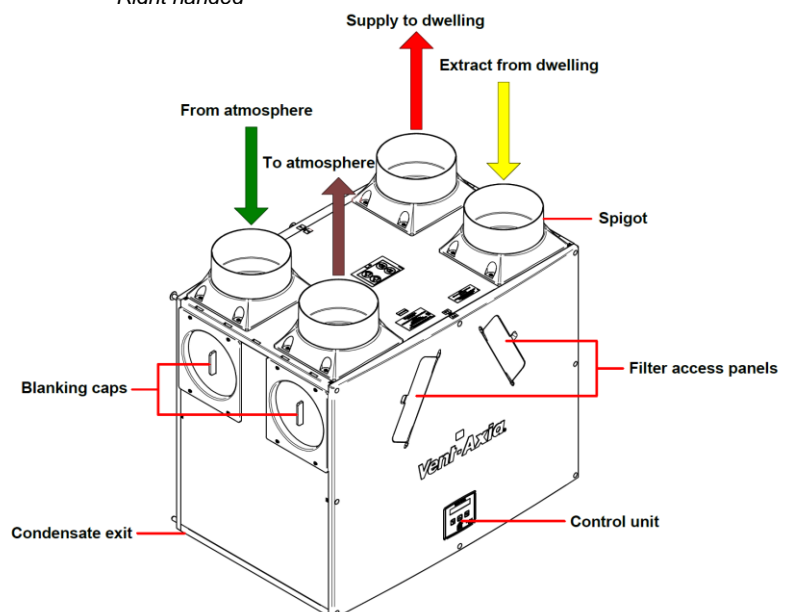

Fig 4: Sentinel Kinetic F, Sentinel Kinetic Plus and High Flow Left handed

Models

- **438222 - Sentinel Kinetic B Right**, right handed with summer bypass.
- **438222L - Sentinel Kinetic B Left**, left handed with summer bypass.
- **443319 - Sentinel Kinetic BH Right**, right handed with summer bypass and integral humidity sensor.
- **443319L - Sentinel Kinetic BH Left**, left handed with summer bypass and integral humidity sensor.
- **408167 - Sentinel Kinetic FH Right**, right handed with summer bypass and integral humidity sensor.
- **408169 - Sentinel Kinetic FH Left**, left handed with summer bypass and integral humidity sensor.
- **443028 - Sentinel Kinetic Plus B Right**, right handed with summer bypass and integral humidity sensor.
- **447938 - Sentinel Kinetic Plus B Left**, left handed with summer bypass and integral humidity sensor.
- **408449 - Sentinel Kinetic High Flow Right**, right handed with summer bypass and integral humidity sensor.
- **408451 - Sentinel Kinetic High Flow Left**, left handed with summer bypass and integral humidity sensor.

Accessories

- **441838 - Sentinel Kinetic Plug-in integral humidity sensor**
- **442367 - Monza System Cooker Hood 600mm wide**
- **442368 - Latina System Cooker Hood 900mm wide**
- **443283 - Wired Remote Control.**
- **447340 - Opto-Coupler**
- **409761 - Spigot Adaptor Kit 200mm – (High Flow)**
- **448356 - LED**

A range of sensors can be used to manage system demand and control the ventilation rate. These include an internal humidity sensor, humidity sensors for independent mounting in rooms, CO₂ sensor, Vent-Wise sensors, manual switches and pull cords. For these alternative control options, see www.vent-axia.com

Technical Data

Performance	Sentinel Kinetic	Sentinel Kinetic F	Sentinel Kinetic Plus	Sentinel Kinetic High Flow
Airflow	Maximum, FID, 290 m³/h Low default 20% Normal default 30% Boost default 50% Purge 100% (For commissioning graphs see page 10)	Maximum, FID, 335 m³/h Low default 20% Normal default 30% Boost default 50% Purge 100% (For commissioning graphs see page 11)	Maximum, FID, 500 m³/h Low default 20% Normal default 30% Boost default 50% Purge 100% (For commissioning graphs see page 12)	Maximum, FID, 650 m³/h Low default 20% Normal default 30% Boost default 50% Purge 100% (For commissioning graphs see page 12)
Power				
AC Voltage Input	220-240 V AC (single phase)			
AC Frequency Input	50 Hz nominal			
Supply Fuse	3 A (located in fused spur)			
Product Fuse	2 A (located on main PCB)			
Rated Power	150 W (max.)	180 W (max.)	190 W (max.)	360 W (max.)
Physical				
Height (excluding spigots)	550 mm	550mm	630 mm	630 mm
Width (excluding spigots)	550 mm	555mm	775 mm	775 mm
Depth	285 mm	350mm	524 mm including filter flap hinge protrusion	524 mm including filter flap hinge protrusion
Weight	15 kg	19 kg	24 kg	31 kg
Spigot diameter	125 mm	125 mm	150 mm	180 mm
Condensate pipe diameter	22 mm			
Environmental				
IP Rating	IP22			
Operating Temperature	-0°C to +45°C			
Air Intake Temperature	-20°C to +45°C			
Operating Humidity	0% to 95% RH			
Storage Temperature	-20°C to +45°C			
Storage Humidity	0% to 95% RH			
Software Version	V426			

For all other technical details, please see the Product Catalogue or our website at www.vent-axia.com

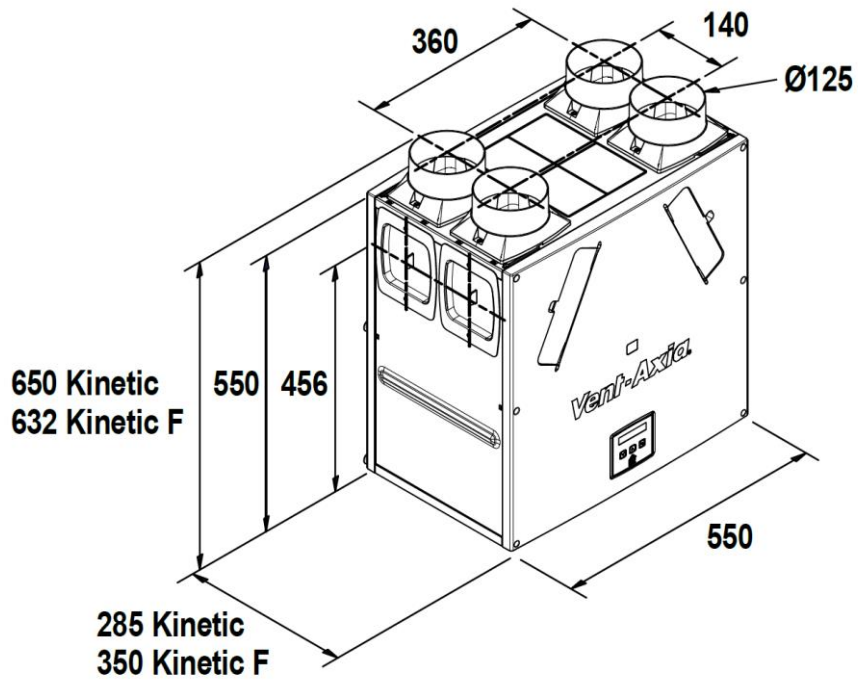

Figure 5: Sentinel Kinetic Dimensions

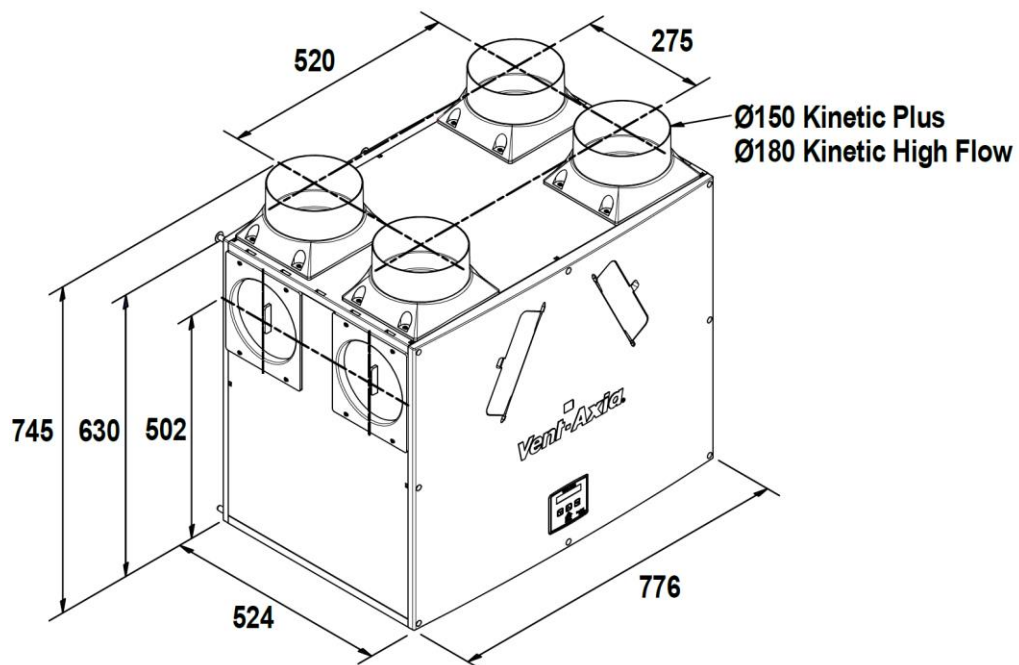
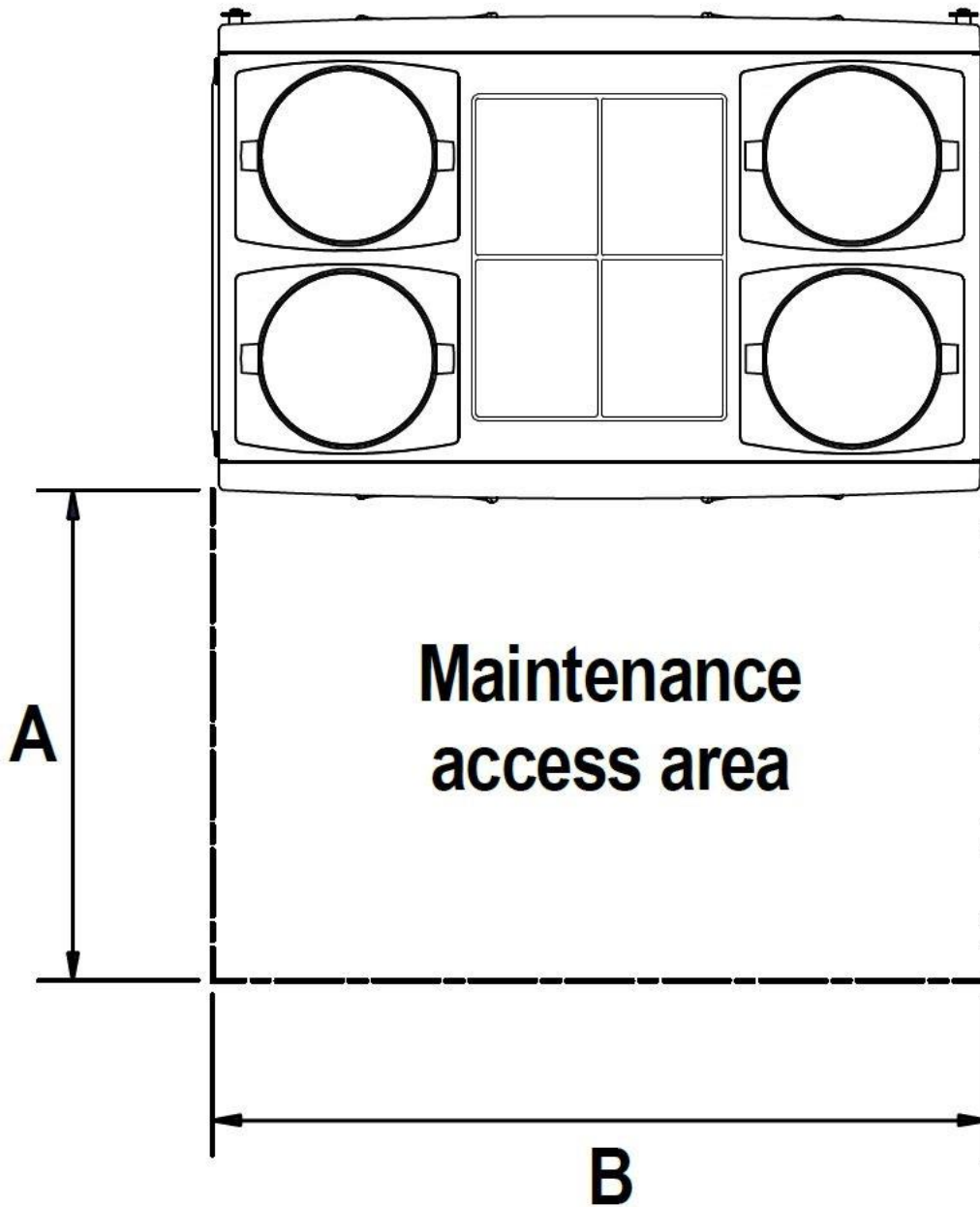

Figure 6: Sentinel Kinetic Plus and Sentinel Kinetic High Flow Dimensions



ACCESS AREA DIMENSIONS			
DIMENSION	KINETIC B/BH	KINETIC FH	KINETIC PLUS
A	300	360	540
B	560	560	780

Minimum maintenance access area required in front of kinetic units. (Kinetic Plus & High Flow dimensions the same).

Sentinel Kinetic Performance graph for Vertical Discharge

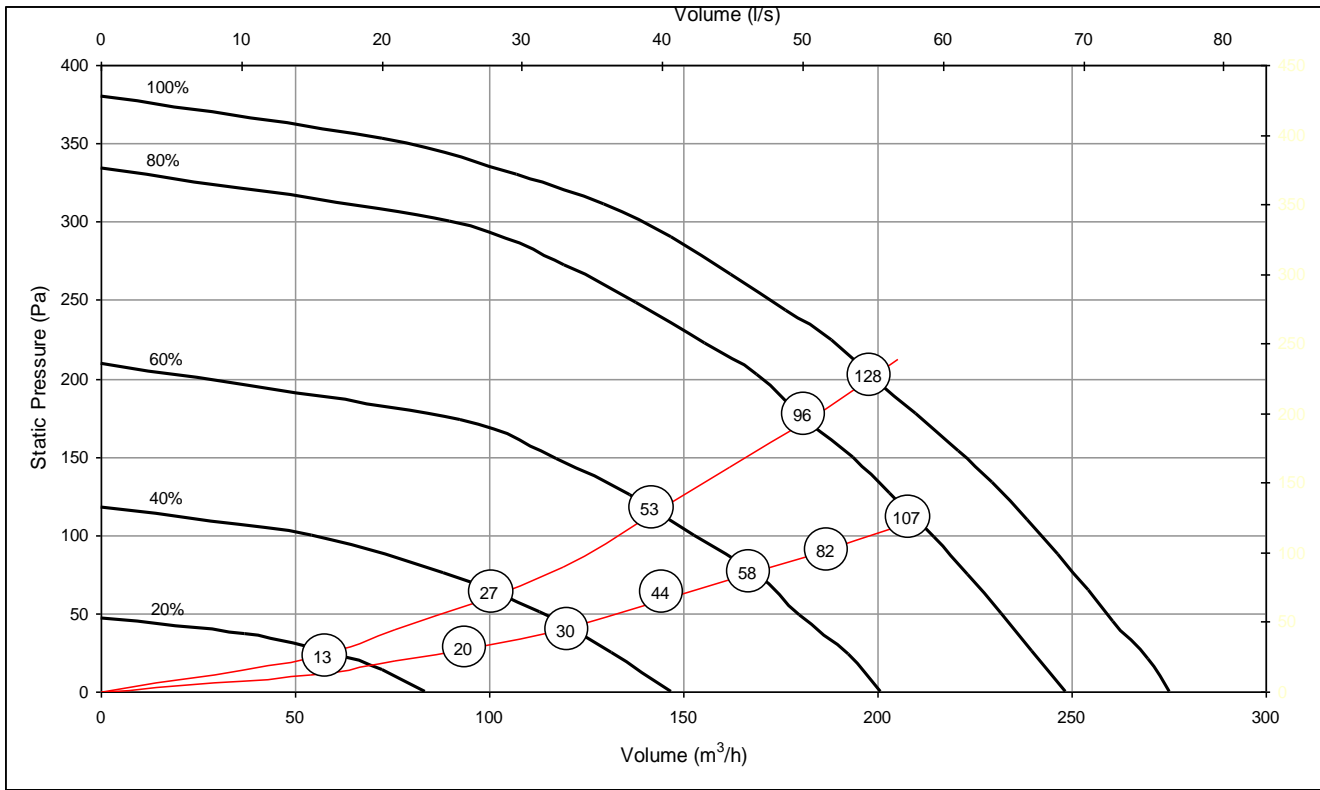

Sentinel Kinetic Performance graph for Horizontal Discharge

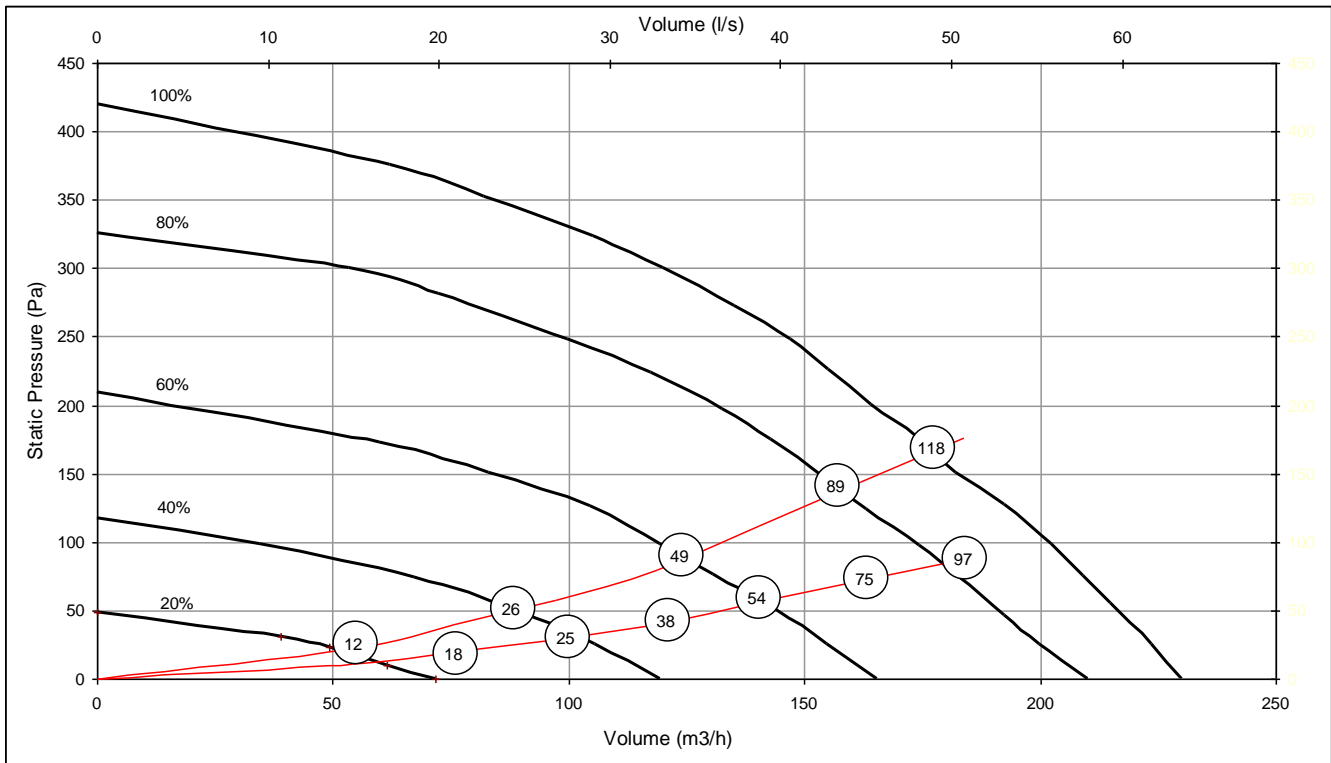

Note: Graphs show 2 typical system curves with total unit input power in Watts.

Sentinel Kinetic F Performance graph for Vertical and Horizontal Discharge

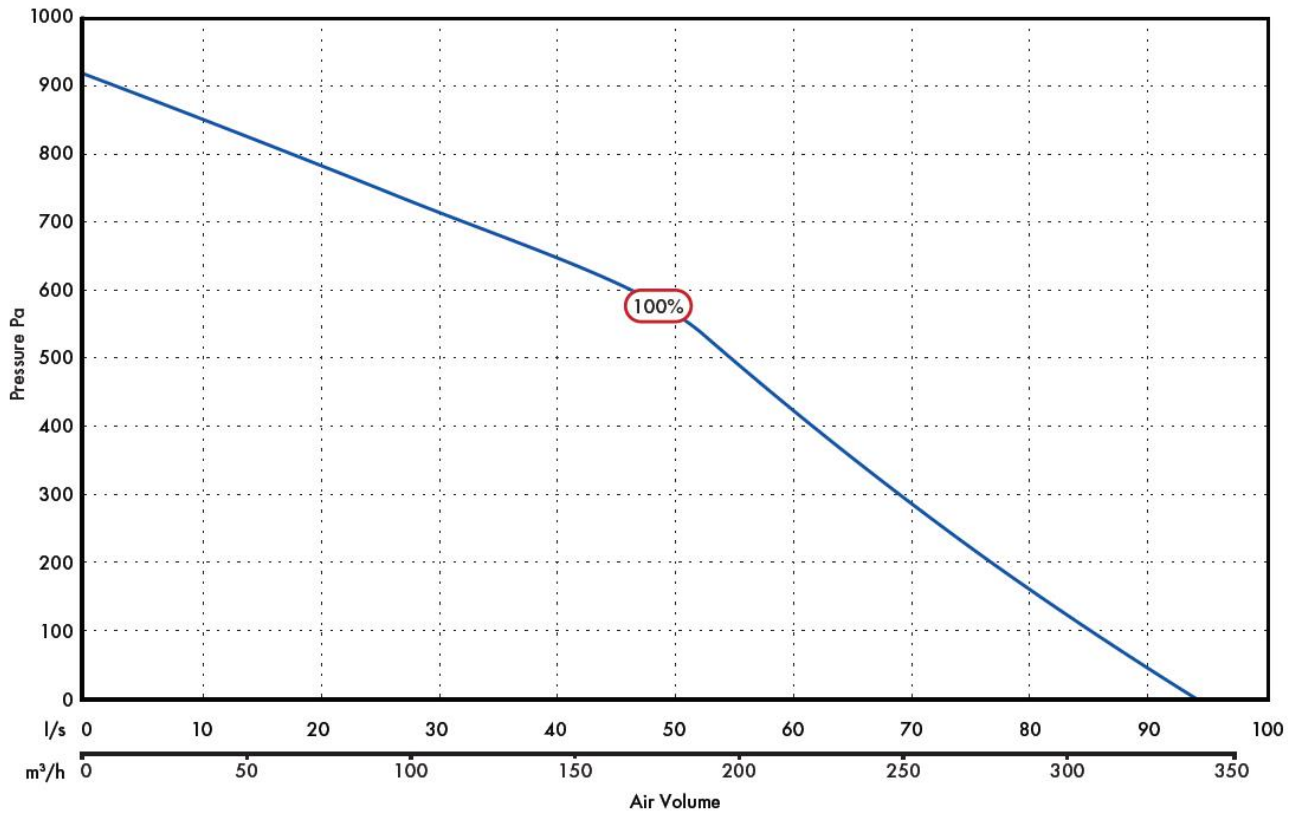

Sentinel Kinetic Plus Performance graph for Vertical and Horizontal Discharge

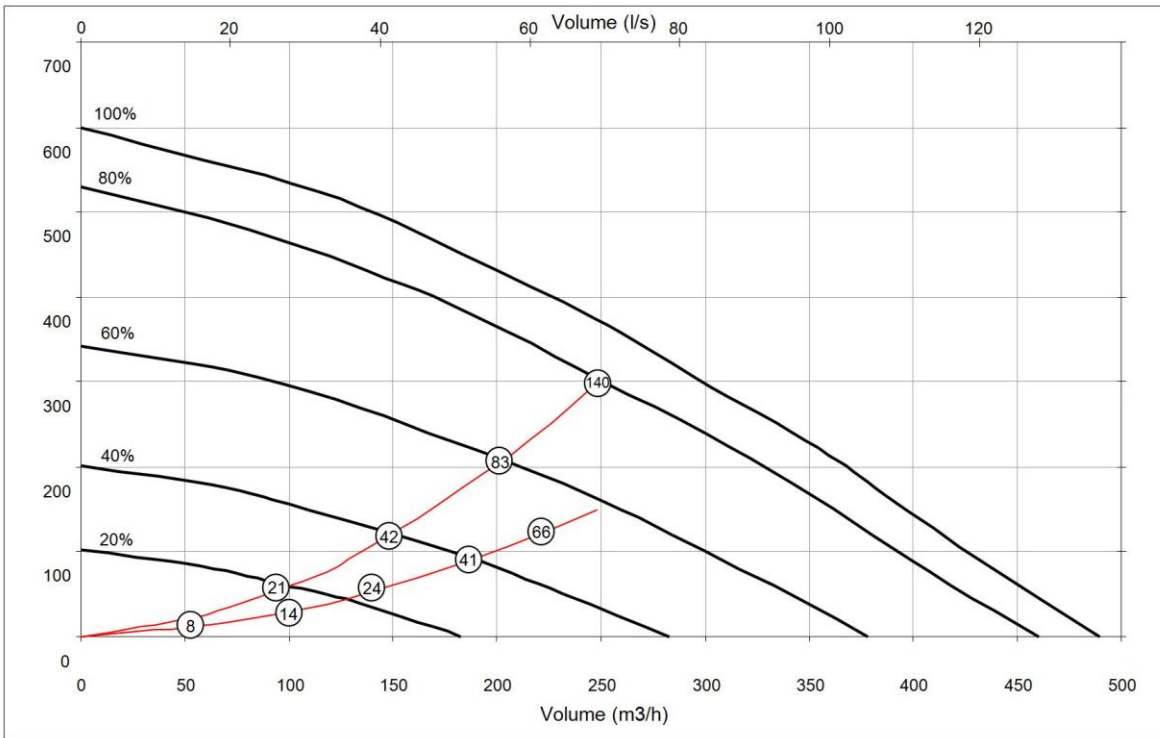

Note: Graph shows 2 typical system curves with total unit input power in Watts

Sentinel Kinetic High Flow Performance graph for Vertical and Horizontal Discharge

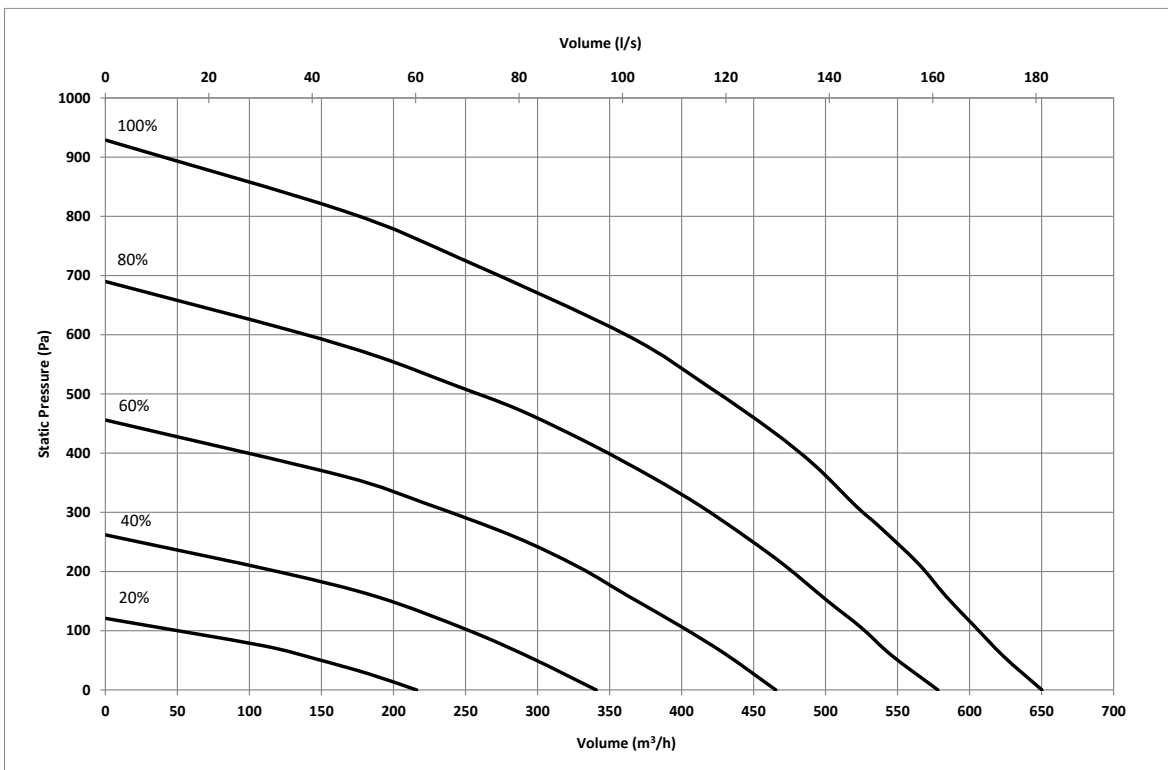

Installation

NOTE:

We advise installers to fix all mains and sensor wiring along with any internal accessories prior to fixing the MVHR unit in position, leaving approximately 500 mm tails to allow for internal routing.

If the orientation of the condensate exit (and the atmosphere spigots) would be better suited on the left of the unit, the front Control Unit and the rear Cable Inlet Plate can be swapped over to allow the unit to be installed in the opposite orientation.

Before Installation of the Unit

Inspect the Unit

When taking delivery of the unit, check the items delivered against the enclosed delivery note. Inspect the unit for damage in transit. If in doubt, contact Customer Services. Each box contains a Kinetic HR unit and an accessory pack containing wall bracket, condensate drain link pipe, pipe clips and product documentation.

Lift and Move the Unit Safely

On page 7 check the weight of the unit that you are installing. Always use appropriate lifting techniques and appliances when moving heavy equipment.

Check Site Requirements and Safety Notices

Check that the physical and environmental conditions for the site meet, or exceed, the requirements detailed in the *Technical Specification* on page 7.

Read and observe the safety notices listed in *Warnings and Safety Information* on page 2.

Unit Installation

The wall should have sufficient strength to support the unit.

Take into consideration the position of the electrical services and the condensate drain.

Ensure there is adequate access for installation, operation and maintenance.

It is recommended that a local disconnection mains and sensor terminal box is installed within 1m of the unit to facilitate future maintenance.

The unit **MUST** always be mounted vertically with ducting exiting vertically or horizontally. Do not use this unit as a support for any other equipment.

If installing in a cold void for optimum performance insulate the unit

Vertical Discharge Condensate Installation

Note

The 22 mm diameter condensate pipe is suitable for standard 22 mm plastic push-fit fittings and can be connected vertically underneath the unit or horizontally at the rear.

To install the vertical discharge condensate:

1. For vertical discharge, remove the rear cover and locate the condensate stub at the rear of the unit.



2. Remove the black Cap from the end of the condensate stub at the rear of the unit.



3. If not already fitted, fit the flexible condensate pipe and secure with worm drive clip

The condensate pipe can be attached with a worm drive clip to a 22 mm vertical pipe.

Fit a 'U' bend condensate drain having a minimum of a 60mm water seal or a HepVo valve to the building's foul water drainage system and ensure there is a minimum 3 degree fall to allow condensate drainage.

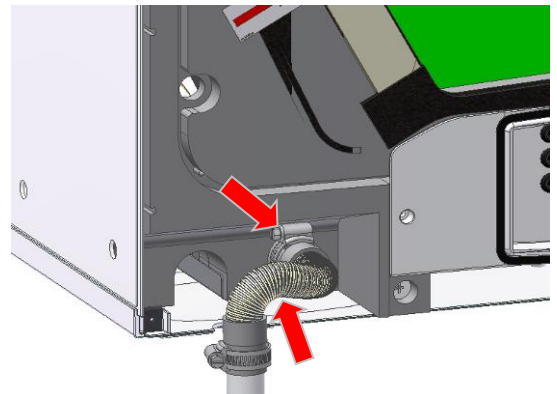

4. Go to Spigot Installation on page 17.

Horizontal Discharge Condensate Installation

To install the condensate horizontal discharge:

1. For horizontal discharge, remove the front cover and locate the condensate stub at the front of the unit.



2. Remove the Black Cap from end of condensate stub at the front of the unit.

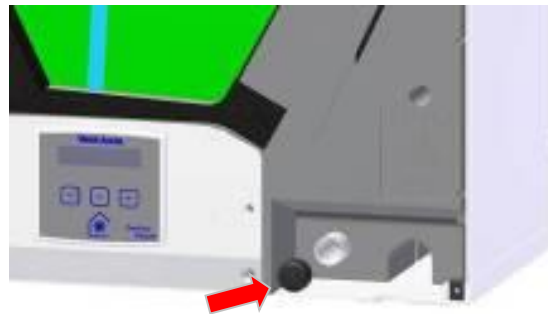

3. On the Kinetic drill a diameter 32 mm hole where shown, right.

On the Kinetic Plus drill a diameter 32 mm hole using the indent provided in the moulding as a guide.

The hole is a clearance hole for a diameter 22 mm pipe and so may vary a little from this guidance.

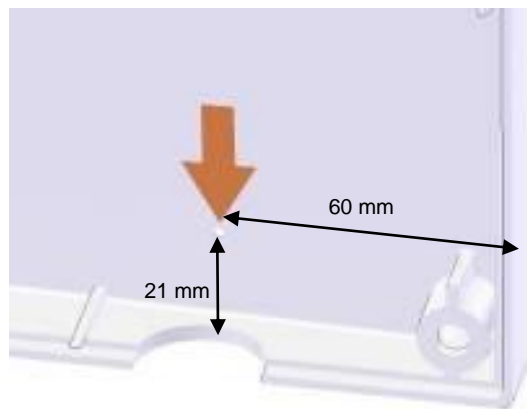

4. **N.B. SEE “WALL MOUNTING” on page 18 for information on marking out the wall for the position of the condensate drain and wall mounting brackets.**

Fit Vertical discharge 32mm waste pipe (fitted with 22 / 32mm reducer).

Fit a ‘U’ bend condensate drain having a minimum of a 60mm water seal or a HepVo valve to the building’s foul water drainage system and ensure there is a minimum 3 degree fall to allow condensate drainage.



5. Fit the flexible condensate pipe to a 22mm diameter x 280mm long condensate pipe with worm drive clip.

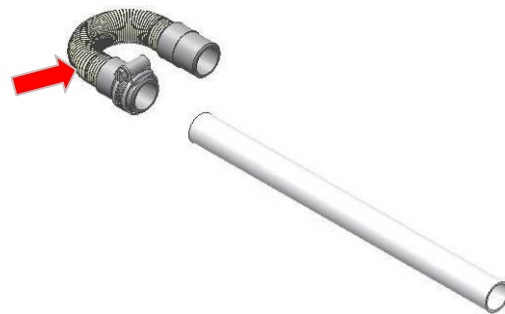

6. *Fit pipe assembly into waste pipe and secure to condensate spigot with worm drive clip.*



N.B. Always insulate condensate pipe if installing in a cold void

Spigot Installation

Air entry/exit spigots may be fitted on either the top or the side of the unit for vertical or horizontal entry or exit. Attach the spigots, depending on the space available for the ducting and orientation of the unit. Always fit the blanking caps to the entry or exit hole not in use to ensure the correct airflow into and out of the unit.

Note: Sentinel Kinetic Plus units have spigots suitable for either diameter 150mm ducting (UK model) or for diameter 180mm ducting (rest of EU model). The diameter 180mm spigots come complete with self-adhesive foam adaptors to enable it to be used with either diameter 180mm ducting or diameter 200mm ducting. These foam adaptors are to be fixed to the outside of the spigot for diameter 200mm ducting. High Flow units are supplied with 180mm spigots, an accessory pack of four self-adhesive foam adaptors part no. 409761 is available for use with 200mm ducting.

To move the spigots:

1. Remove the spigot by unscrewing the screw(s) securing it to the chassis. Then pull the spigot firmly from the entry/exit hole.
2. Remove the blanking cap by unscrewing the screw(s) securing it to the chassis. Then pull the blanking cap firmly from the entry/exit hole.
3. Swap over the spigot with the removed blanking cap.
4. Insert the spigot into the entry/exit hole and secure with the retaining screw(s).
5. Insert the blanking cap into the entry/exit hole and secure with the retaining screw(s).

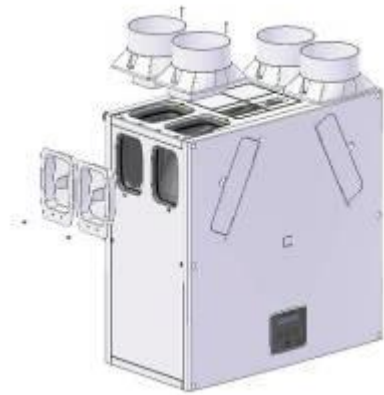

N.B. Before finally fixing the unit into position it may be more convenient to make the electrical connections; including the mains connections and any wiring for sensor(s) or switch(es).

Wall Mounting Sentinel Kinetic & Kinetic F

1. Refit the front and rear covers if they have been removed.
2. Ensure the two steel wall bushes are fitted to the rear cover, along the top row of screws.
3. Mark the condensate and wall bracket positions.
4. Fit the stand-off feet in place, supplied in the accessory bag.
5. Fit metal wall bracket (supplied) to the wall using appropriate fixings.
6. Lift unit and locate the steel wall bushes onto the wall bracket. The unit should now be physically installed in its intended operating location.
7. Ensure that the condensate drain is connected as described on page 15.

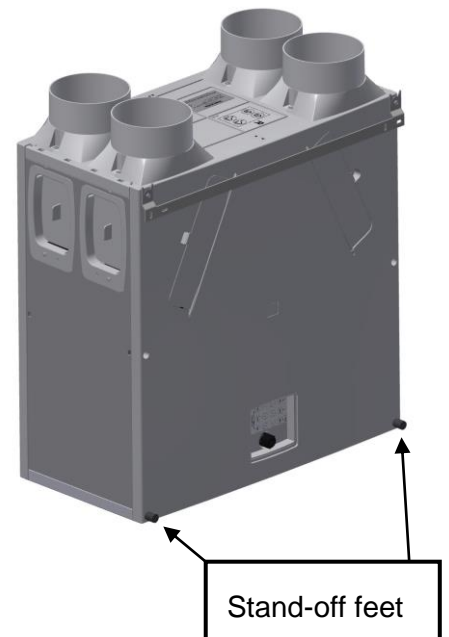

Installation

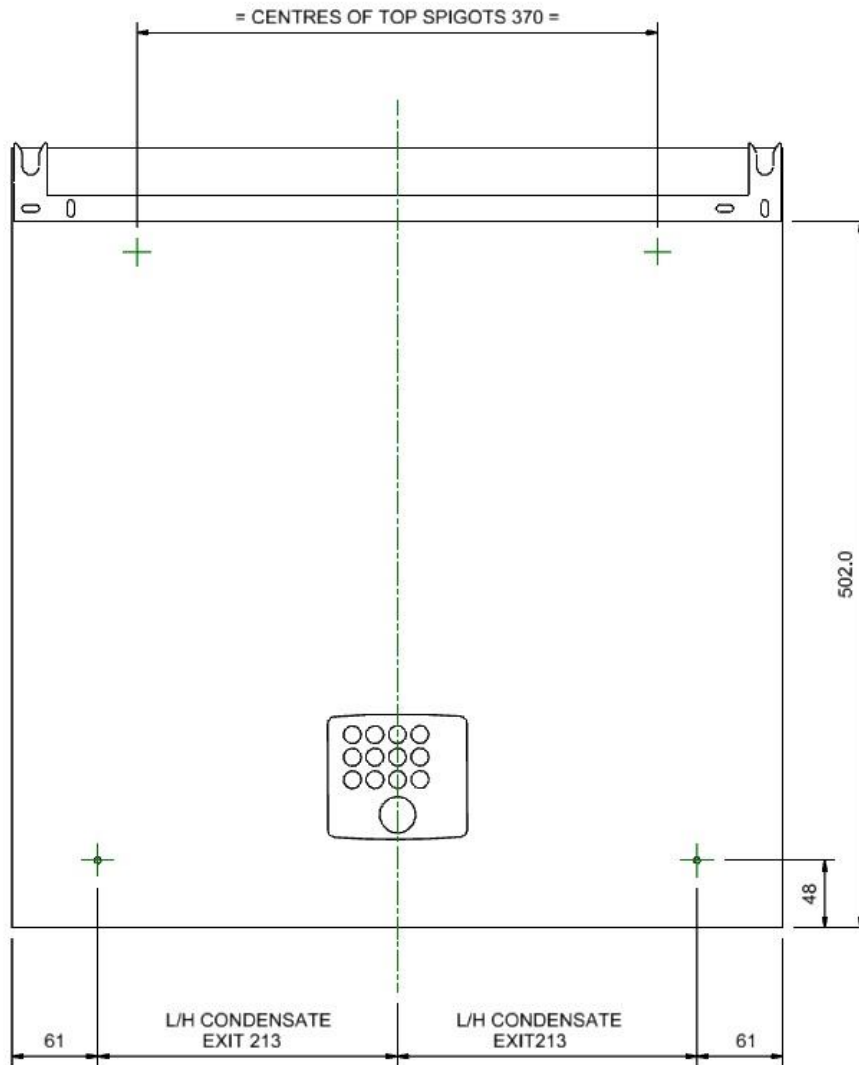

Installation

1. Refit the front and rear covers if they have been removed.
 2. Ensure the three steel wall bushes are fitted to the rear cover, along the top row of screws.
 3. Mark the condensate and wall bracket positions using the drawing below.
 4. Fit metal wall bracket (supplied) to the wall using appropriate fixings.
 5. Fit the stand-off feet in place, supplied in the accessory bag.
 6. Lift unit and locate the steel wall bushes onto the wall bracket.
- The unit should now be physically installed in its intended operating location.
7. Ensure that the condensate drain is connected as described on page 15.

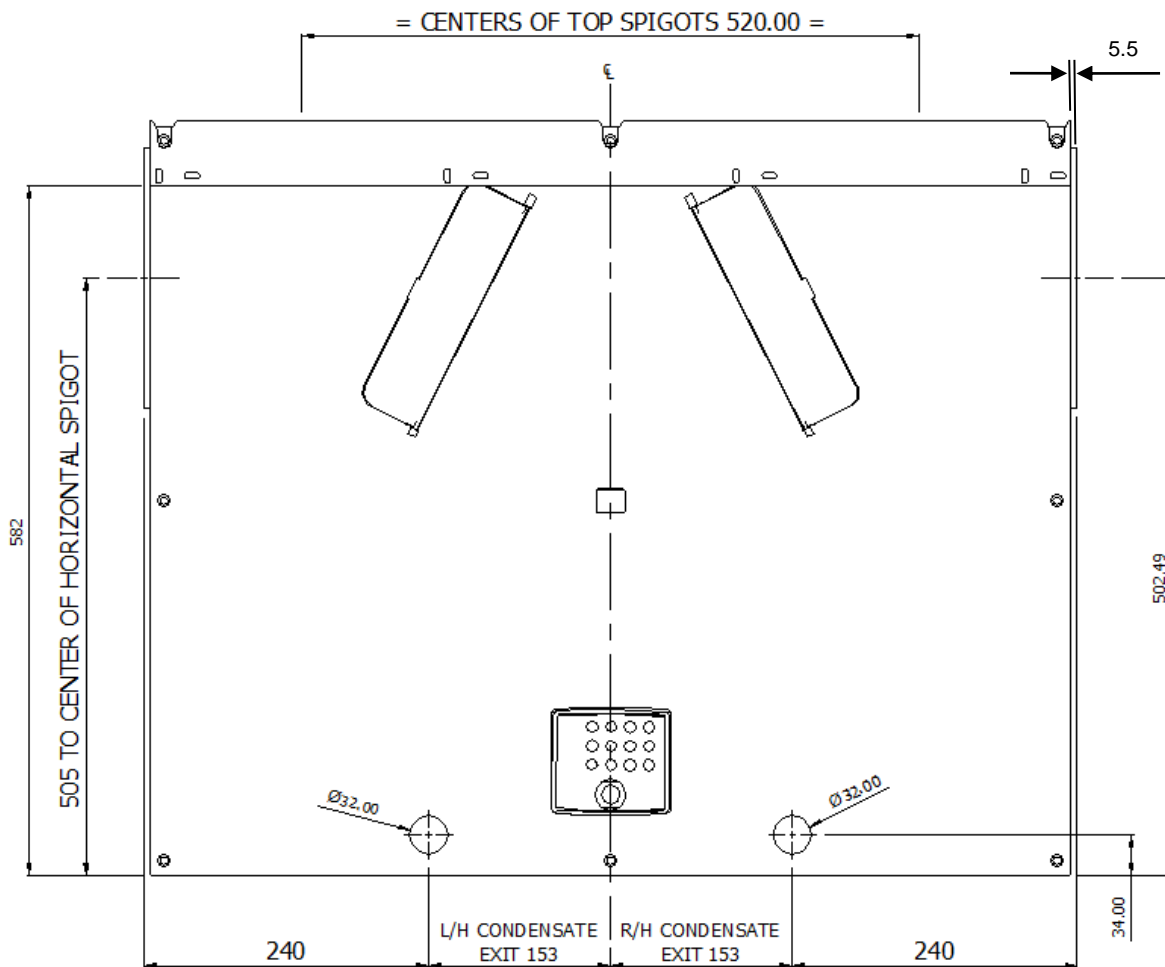
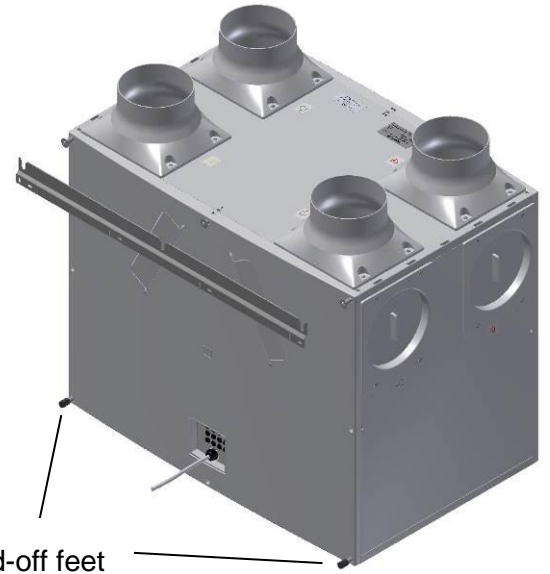

Wall Mounting Sentinel Kinetic Plus & Sentinel Kinetic High Flow

Floor Mounting Sentinel Kinetic Plus and Kinetic High Flow

1. Remove the front and rear covers.
2. Ensure that a secure, firm, flat and level surface is provided to place the Kinetic Plus unit on.
3. Screw down through the white plastic base plate of the unit to a board which may then be screwed to joists, flooring or equivalent.
4. The unit should now be physically installed in its intended operating location.

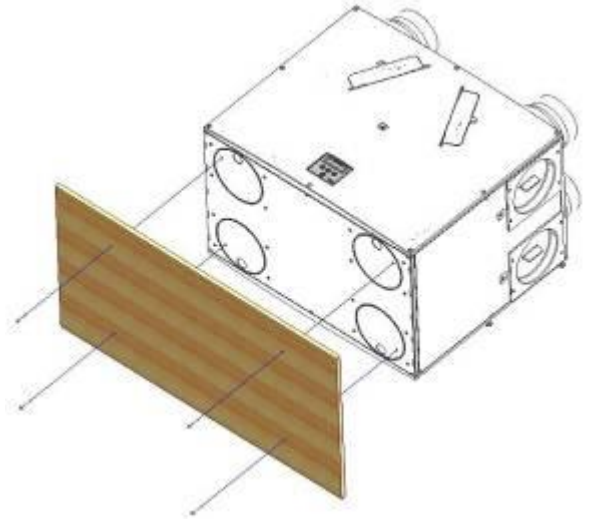

Attach the ducting:

1. Always use a short piece of flexible duct 100-150 mm long, extended to its full length when connecting to ductwork.
2. Securely connect this ducting to the spigots using worm-drive clips or cable ties.
3. Insulate all ducting running to and from atmosphere and any ducting that passes through an unheated space.

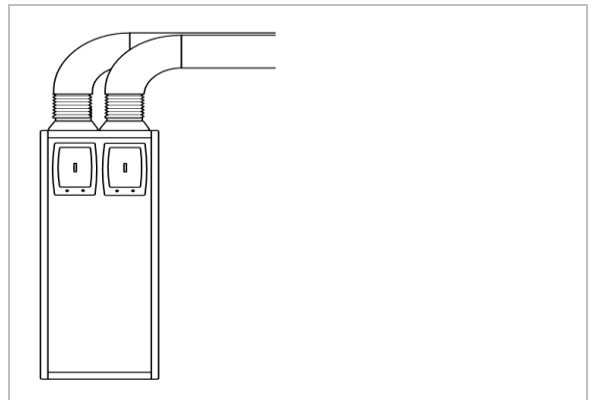

Electrical Installation

Connect Switches and Sensors

The unit can be switched to boost by a variety of methods:

- Applying 240 V to the LS input .
- Switching across 1 of 5 pairs of switch terminals.
- Applying between 0 and 10 V as a proportional input to two input terminals.

N.B Alternative functions are assigned to SW/1, SW/2, SW/3 & SW5 when Control Mode 02 is selected in the start-up screens see Appendix One for further details.

Terminal 4 can be used in conjunction with a momentary switch or switches.

Connect any switches or sensors required to control the unit by connecting to the terminal connectors at the bottom of the control unit as shown below and in Table 1. If necessary contact Vent-Axia regarding the wiring and fixing of accessories and sensors.

The cable entry back plate may have grommets or easy knock-out positions. If the knock-outs are used then ensure that you use a grommet or gland to protect against potential water ingress.

When fitting external controls the appropriate cord anchorage and glands, according to country requirements for cable size should be fitted, these glands should have a minimum water ingress protection of IPX2.

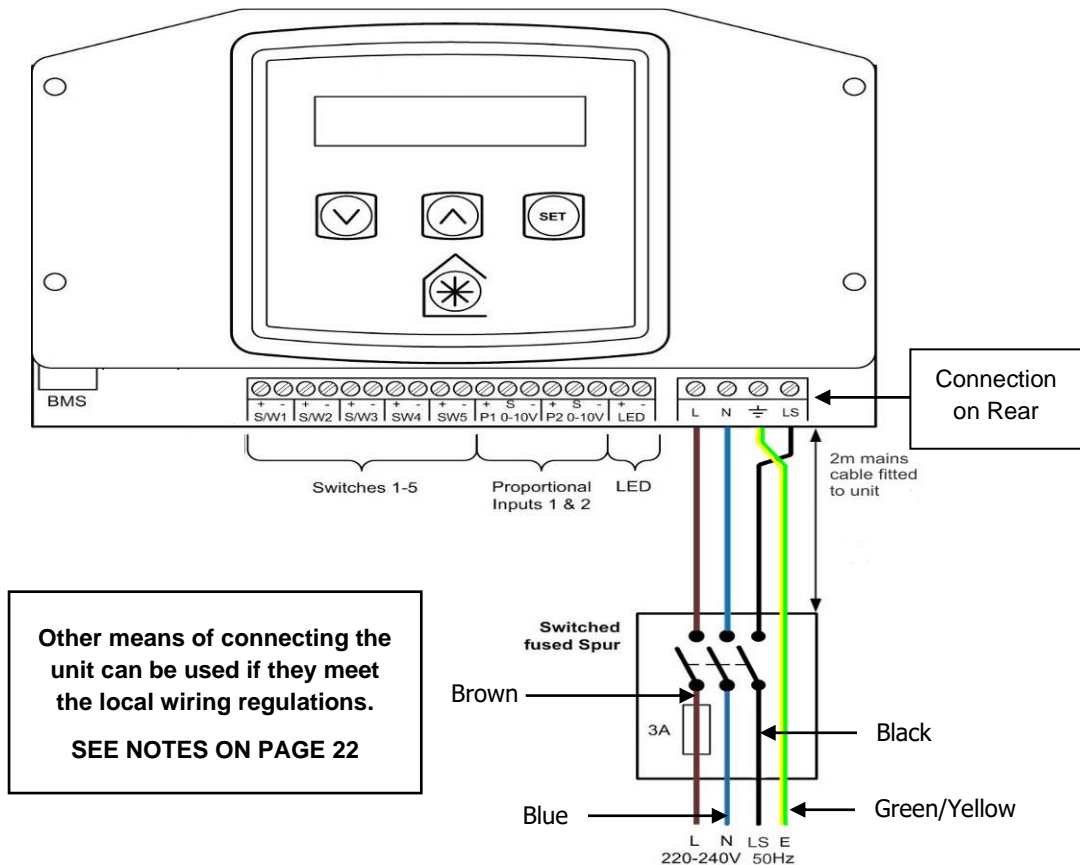

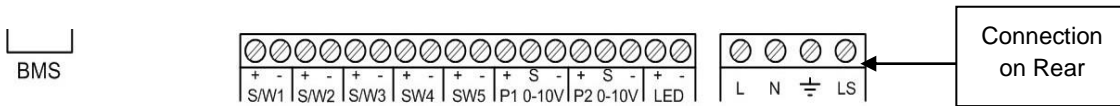

Table 1: Terminal Connections

Terminal No.	Name	Description (Control Mode 01)
S/W1	Switch 1	With link fitted on J4 - activates volt-free contact for sensor input between + and - terminals
S/W2	Switch 2	
S/W3	Switch 3	
SW4	Switch 4	Volt-free contact for sensor input between + and – terminals (Momentary if SW/4 if SW4 Commissioning Screen set On) With Vent-Wise PCB fitted to J4 - enables Vent-Wise momentary switch input
SW5	Switch 5	Volt-free contact for sensor input between + and - terminals
P1 0-10V	Proportional 1	A 24 V DC sensor supply is output between the + and - terminals. A 10 V proportional sensor input is received between S and - terminals
P2 0-10V	Proportional 2	A 24 V DC sensor supply is output between the + and - terminals. A 10 V proportional sensor input is received between S and - terminals
LED	Red Light Emitting Diode Output	A LED driving signal output between the + and – terminals that enables remote indication of a unit fault. See the Control Panel for fault code (see <i>Service/Fault Code Screens</i> on page 42). Also used for as connection to a BMS or similar.
L	Mains Live	220-240 V AC, 50 Hz input
N	Mains Neutral	220-240 V AC, 50 Hz input
EARTH	Mains Earth	Earthing connector
LS	Switched Live	220-240 V AC, 50 Hz input

N.B Alternative functions are assigned to SW/1, SW/2, SW/3 & SW/5 when Control Mode 02 is selected in the start-up screens see Appendix One for further details

Connect the Power Supply



WARNINGS

1. MAINS SUPPLY VOLTAGES (220-240 V AC) ARE PRESENT IN THIS EQUIPMENT WHICH MAY CAUSE DEATH OR SERIOUS INJURY BY ELECTRIC SHOCK. ONLY A QUALIFIED ELECTRICIAN OR INSTALLER SHOULD CONNECT THE POWER SUPPLY TO THIS UNIT.
2. THIS UNIT MUST BE CORRECTLY EARTHED.

This unit is designed for operation from a single-phase alternating current source (220-240 V AC). A 1.5 m cable is connected internally to the unit for connection to an isolator switch.

To connect the power supply:

Ensure the local AC power supply is switched off.

One end of the power cable supplied is already connected to the unit and routed through the Cable Inlet Plate via a suitable gland to ensure the IP rating of the unit is not affected.

Connect the other end of the cable to the switched fused spur.

Use cable clamps and clips to secure the cable, as appropriate.

Connecting a Boost (Light) Switch

A Switched Live (LS) may be used to boost the airflow when a light is turned on, for instance in a bathroom or kitchen. If the LS core of the mains cable is not used it should be terminated in an appropriate manner.

NOTES

Power supplied to the unit via a 3 pole isolating switch, such as Vent-Axia Part Number 563518, must be supplied via the same circuit as the LS connection. Alternatively an isolator relay controller, part number 442030, may be used. The live supply to the unit should be fused at 3A.

Example wiring diagrams are available via Vent-Axia Technical support, e.g. Drawing Number 448144.

Sentinel Kinetic Range Summer By Pass Models.

The Sentinel Kinetic B, BH, Plus B, Plus BS and S BH are fitted with a Summer By Pass (SBP) and will provide energy-free cooling when the house temperature and ambient temperature allows.

Note that the volume of air provided by this ventilation system is a fraction of that required for space heating or space cooling and will not in itself be sufficient to cool a room. It will however, provide a contribution and make a difference.

There are three operating modes, Normal, Evening Purge and Night-time purge.

Normal Mode.

Air flow rate is determined by sensors, boost and timing settings, otherwise is normal rate.

If the room is warmer than the set (shown as "indoor") temperature (i.e. you need the room to be cooler) and the outdoor air is cooler than the actual room temperature (i.e. the outdoor air could cool your room) then the SBP will open and the unit will supply cooler air to your room.

Note that the above only applies whilst the outdoor air temperature is above 14 C (adjustable) in order to prevent cold draughts.

The set ("indoor") temperature should be set 2 or 3 degrees higher than the central heating thermostat and 2 or 3 degrees below any air conditioning thermostat if fitted. This will prevent any clash between the separate systems.

Evening purge Mode.

Intended for use as the outdoor temperature cools in the evening, but reverts to normal control after a set time so that any increase in noise is avoided overnight.

Air flow rate is always at boost.

The bypass closes and the purge stops if the temperature conditions described in Standard Mode are no longer met or 5 hours after the bypass opened.

Night-time purge Mode.

Intended for use as the outdoor temperature cools in the evening and continues through the night when cooling is a higher priority than any increase of noise. Note that the air noise in your system is influenced by the ducting design and layout and the size and type of vents used in the rooms. If improvements are required speak to your installer.

Air flow rate is boost.

The bypass closes and the purge stops if the temperature conditions described in Standard Mode are no longer met.

Powering Up the Unit

Switching On

To switch the unit on:

1. Switch on the power at the mains supply isolator feeding the unit.
2. Following switch-on, the fan motors will start and the Control Unit will display a series of start-up screens, described below (see *Start-up Screens* on page 24).
3. **N.B. If you are intending to carry out work or maintenance inside the unit, switch off the power at the mains outlet supplying the unit before you remove the covers.**

Switching Off

To switch the unit off:

1. Turn the power off at the mains supply isolator.

Control Unit Display

The Control Unit is located at the front of the Sentinel Kinetic unit. The Control Unit provides the user interface for commissioning and monitoring purposes.



Display

The main display is a 16 character by 2-line liquid crystal display (LCD) with automatic backlight, which is turned off to automatically minimise power consumption.

Normal Airflow
30%

Buttons

Four buttons on the Control Unit provide the controls for configuring and monitoring the unit.

Button	Function
	Press to adjust settings and press to save settings.
	Press to go to the previous screen or to increase a parameter value. Press and hold for more than 2 seconds for fast scrolling.
	Press to go to the next screen or to decrease a parameter value. Press and hold for more than 2 seconds for fast scrolling.
	Press to activate Boost mode. See page 25 for options. Press and hold for 5 seconds to activate Purge mode. (Press and hold for 5 seconds to cancel Purge).

Start-up Screens

(Refer to Control Mode 01 unless otherwise indicated)

Sentinel Kinetic Version Screen

The Sentinel Kinetic Version screen displays the firmware version number for 3 seconds.

No adjustments are possible on this screen.

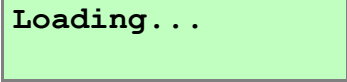

Loading...

Language Screen

The Language screen displays the language used for the screens. It is typically displayed for 5 seconds, or longer if changing the setting.

(To re select a new language disconnect and then reconnect to the mains supply).

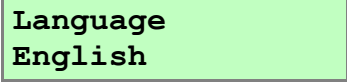

Language
English



Control Mode Screen

Selects between Control Mode 01 operation described herein and the alternative Control Mode 02 described in Appendix One.

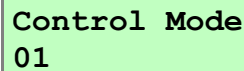

Control Mode
01

Airflow Units Screen

The Airflow Units is a percentage of the unit's maximum flow.

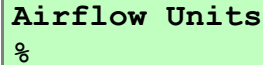

Airflow Units
%

Wireless Control Screen

The Wireless Control screen automatically displays whether the wireless boost control switch is fitted. It is typically displayed for 3 seconds.

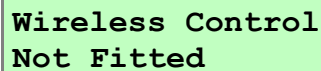

Wireless Control
Not Fitted

Humidity Sensor Screen

The Humidity Sensor screen displays whether the humidity sensor is fitted. It is typically displayed for 3 seconds.

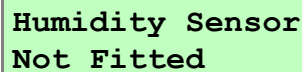

Humidity Sensor
Not Fitted

Low Airflow / Normal Airflow / Boost Airflow Screen

When the start-up screens are finished, the low or normal screen is displayed showing operating status (Low Airflow X % or Normal Airflow X % or Boost Airflow X %).

The Normal screen displays the rate of normal airflow (supply air) through the unit.

If the installation has proportional sensors or an internal humidity sensor fitted, and any of these are boosting the airflow, an α symbol will be displayed.

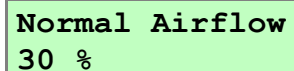

Normal Airflow
30 %

If Control Mode 02 has been selected then the Normal Airflow screen includes either “Auto” or “Manual” to indicate if the boost level has been triggered by the button on the controller or automatically via a sensor.



Normal Airflow
30% Auto

When the summer bypass is active, the normal screen top line will alternate (for 3 seconds) with Summer Bypass On.

Summer Bypass On
30 %

An interval can be set, see page 40, at which the unit reminds the user to check the filters. The normal screen top line will include Check Filter as a reminder to check and, if necessary, clean or replace the filters.

Check Filter
30 %

When this has been done, press and hold the  and  buttons for 5 seconds to reset the automatic message.

Pressing the  button activates the boost airflow mode when extra ventilation is required.

Boost Airflow
50 %

No. of presses	Boost action (Control Mode 01)
1	Boosts for 30 minutes
2	Boosts for 60 minutes
3	Boosts continuously
4	Back to Normal flow rate

N.B Additional airflow modes are available from the  button when Control Mode 02 is selected in the start-up screens see Appendix One for further details.

If the wireless boost option is fitted, this can be triggered from the wireless transmitter/boost switch.



If the installation has switch sensors, is wired to the lighting, has Vent-Wise sensors, Vent-Wise momentary switch or if the internal time switch is set for periodic operation, operation will change from normal to boost automatically. Pressing the  button will reveal a code to show which device has activated boost.

- s1 = Switch S/W1
- s2 = Switch S/W2
- s3 = Switch S/W3
- s4 = Switch SW4
- s5 = Switch SW5
- ls = Switched live (LS)
- c1-3 = Internal Time switch

If running on boost due to pressing the  button, another device may ‘take over’ the boost. Flow will return to normal when that device switches off. If a number of different devices are calling for boost flow, the unit will run at boost until the last one has reverted to normal.

N.B Alternative functions are assigned to S/W1, S/W2, S/W3 & SW5 when Control Mode 02 is selected in the start-up screens see Appendix One for further details.

Purge Screen

Pressing and holding the  button for approximately 5 seconds activates purge mode when you want to purge air from the building. The unit will revert to normal flow by pressing and holding the  button again for 5 seconds. If the wireless boost option is fitted, purge can be triggered from the wireless transmitter/boost switch.

Purge mode runs the fans at full speed for 2 hours (120 minutes). The Purge screen displays a countdown of the time remaining.



Purge 120m
100 %

Cooker Hood Boost Screen

Cooker Hood mode is activated when the J12, LS input is activated, see page 34 for details.

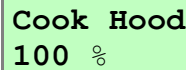

Cook Hood
100 %

Low Airflow Screen

Low Airflow mode is activated when the Normal Airflow is set to **Off**, (see page 33 for set up details).

The Normal Airflow mode can be set to run during the daytime i.e. from 6am to 11pm, the Low Airflow mode will then run during the night from 11pm to 6pm.

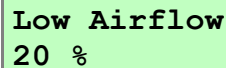

Low Airflow
20 %

Set Clock Screen

From the Normal Airflow screen, simply press the  button once to access the Set Clock screen.

The Set Clock Control screen enables you to change the clock settings. The clock retains its settings for approximately two weeks without mains power, after which it will need resetting when power is reconnected. Values are **DDD HH:MM**.

Return to the normal display by pressing the  button or leave to timeout and return automatically after 2 minutes.

The unit will not automatically switch for daylight saving time.

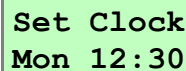

Set Clock
Mon 12:30



Summer Bypass Screen

From the Normal Airflow screen, simply press the  button twice to access the Summer Bypass screen.

If the unit is a summer bypass model, the Summer Bypass screen enables you to switch the summer bypass control on or off. This screen is only displayed when the bypass is fitted. See Page 9 for a description of this function.

Options available are **Normal** (default), **Evening Purge**, **Night time purge** and **Off**.

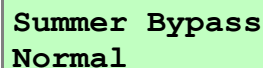

Summer Bypass
Normal



Indoor Temp Screen

From the Normal Airflow screen, simply press the  button until the Indoor Temp screen is displayed.

The Indoor Temp screen enables you to choose the target room temperature in degrees Centigrade – only displayed when the bypass is fitted.

Selectable range is **16-40 (25 default)**.

Return to the normal display by pressing the  button or leave to timeout and return automatically after 2 minutes.

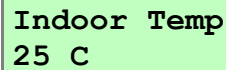

This function will only work when the Summer Bypass is set to on.



Indoor Temp
25 C



Outdoor Temp Screen

From the Normal Airflow screen, simply press the  button until the Indoor Temp is displayed. Press  button to choose the required temperature and then press  button again to confirm the entry and this will call up Outdoor Temp.

The Outdoor Temp screen enables you to choose the minimum outdoor temperature at which the bypass will operate in degrees Centigrade – only displayed when the bypass is fitted.

Use this to prevent cold draughts being introduced.

Selectable range is **5C – 20C (14C default)**.

Return to the normal display by pressing the  button or leave to timeout and return automatically after 2 minutes.

This function will only work when the Summer Bypass is set to on.

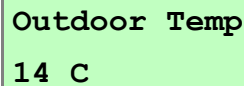

Outdoor Temp
14 C



Return to the normal display by pressing the  button or leave to timeout and return automatically after 2 minutes

Commissioning

Overview

The instructions in this section are intended to provide configuration and operation information for setting up the equipment. In the event of problems, see *Troubleshooting* on page 45

Follow good practice when commissioning the unit. Ensure that the system is installed according to the system designers intent incorporating any acoustic ducting, that all joints are air tight, ducting is well supported, bends are avoided close to vents, and that the vent valves are fully open at the start of the commissioning process.

The following is attached to the unit and should be used as a checklist prior to setting the air flows.













Vent-Axia

MVHR Installation Checklist

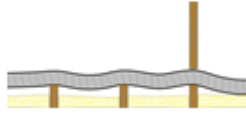
REQUIRED TO BE COMPLETE TO COMPLY WITH CONDITIONS OF WARRANTY,
but does not affect statutory rights.

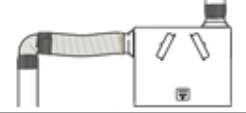
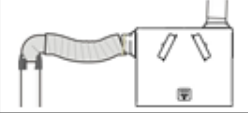
This is a short check list of good practice do's and don'ts that may affect the safety or functionality of the installation. It is not a complete list of what is required. They must be complied with in order to ensure that the installation performs as expected.

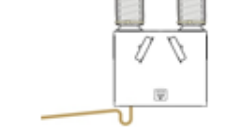
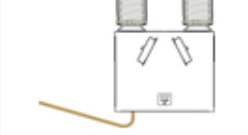
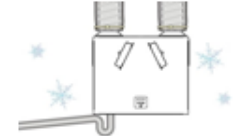
Unit Serial number: _____ Installer's name: _____

Check			Date and initials
1. Is the unit stable and horizontal with room around it to allow maintenance?			
2. Is any flexible ducting pulled taut to prevent moisture collection and avoids airflow issues?			
3. Is any flexible ducting crushed which will cause airflow issues?			
4. Are all joints in the ductwork sealed to prevent air leakage?			
5. Is the ducting insulated to prevent condensation and cooling or heating of the air?			
6. Does the condensate drain a) have the correct slope to ensure water runs away and b) is fitted with a trap to prevent smells coming back into unit?			
7. If the condensate drain passes through a cold space is it insulated to prevent freezing?			

See the Installation Guide and Checklist at: http://www.vent-axia.com/files/domestic_mvhr_installation_compliance_guide_2010.pdf

4440128

0512

Control Unit Screens Summary

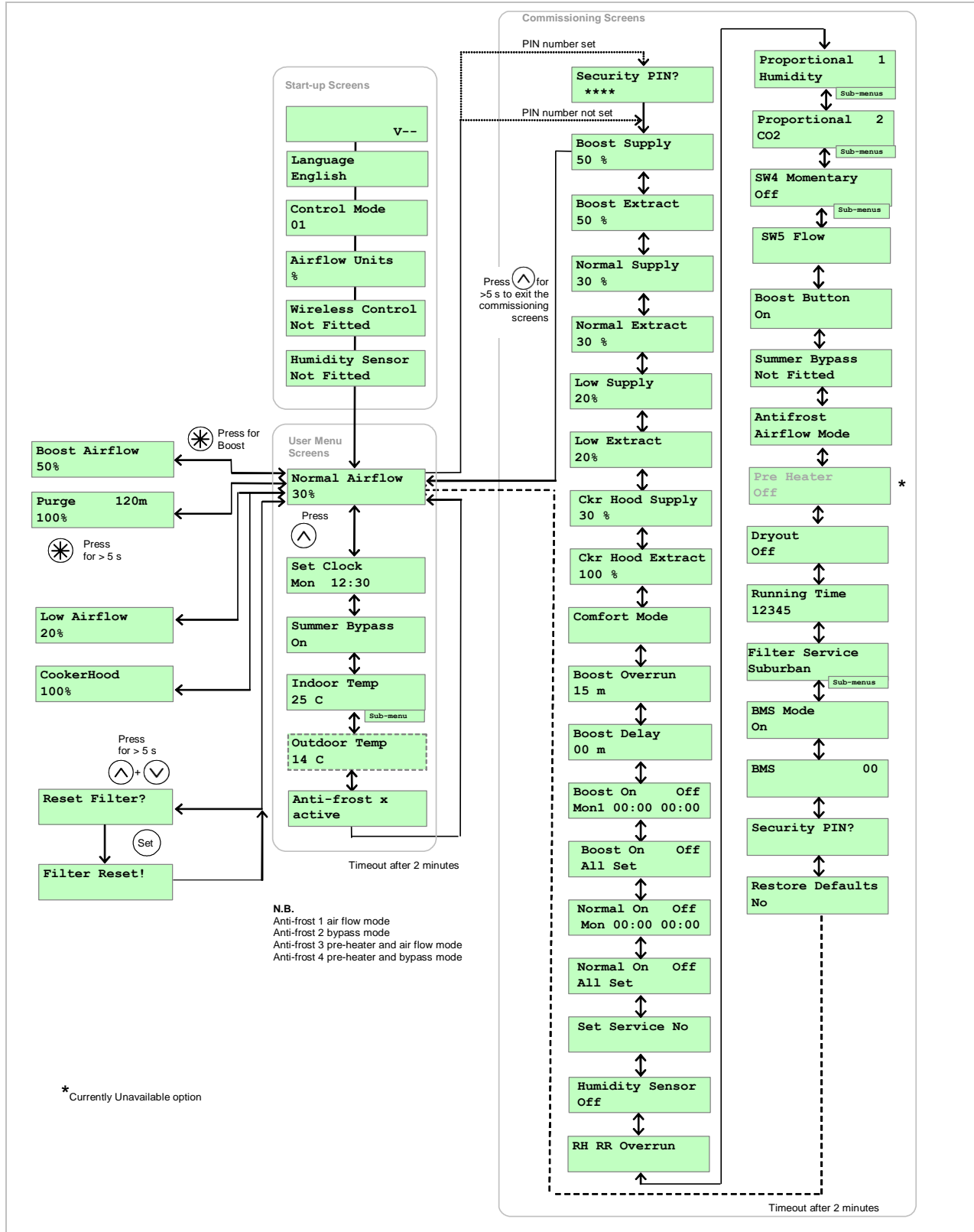

When the unit is switched on (see *Powering up the Unit* on page 24, the following Control Unit screens are available for monitoring and configuring the unit.





Commissioning Screens

The commissioning screens enable you to configure the operational settings of the unit. Settings are stored in a non-volatile memory and will be retained irrespective of mains supply breaks.

Note: Access to the commissioning screens is prevented if the display shows **Antifrost Active**, **Room Too Cold** or a **Fault Code**. In this event, switch the unit off and on again and enter the commissioning screens within one minute. If you are within the commissioning screens the Antifrost and Room Too Cold Failures modes will not operate allowing the flow rates to be adjusted even in a property which is below 5C. For further information see *Troubleshooting* on page 42.

To access the commissioning screens: Press and hold the  button immediately followed by the   buttons together; continue to hold down all three buttons for 5 seconds.

To scroll through the Commissioning Screens use the   buttons.

To return to the normal screen, either press and hold the  button to reach the first menu item and then hold for a further 5 seconds. Alternatively, the normal display will resume if no buttons are pressed for two minutes.

Security PIN Screen

If a security PIN code has been previously set, this screen will display ****.

Enter the PIN using ,  and  buttons.

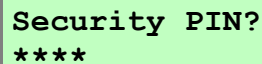

Security PIN?

Note 1

Whilst displaying the Low, Normal, Boost Supply, Low, Normal, Boost Extract screens the fans will run at the displayed % flow and the bypass will remain shut. The two minute automatic return to normal display time is extended to four hours to allow time for measurements or adjustments.

Boost Supply Screen

The Boost Supply screen enables you to set the Boost airflow speed for the Supply fan in order to balance out any differences in ductwork or other installation features.

Default Boost speed = 50%. See graph on page 10,11 or 12 for setting the Supply airflow.

The Boost speed cannot be set above the Cooker Hood speed or below Normal speed setting.

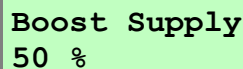

Boost Supply
50 %



Boost Extract Screen

The Boost Extract screen enables you to set the Extract airflow speed for the Extract fan in order to balance out any differences in ductwork or other installation features. Default Boost speed = 50%. See graph on page 10, 11 or 12 for setting the Extract airflow.

The Boost speed cannot be set above the Cooker Hood speed or below Normal speed setting.

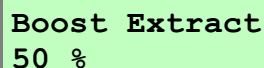

Boost Extract
50 %



Normal Supply Screen

The Normal Supply screen enables you to set the Normal airflow speed for the Supply fan in order to balance out any differences in ductwork or other installation features.

Default Normal speed = 30%

See graph on either page 10, 11 or 12 for setting the Supply airflow.

The Normal speed cannot be set below Low speed or above Boost speed setting.

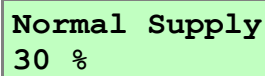

Normal Supply
30 %



Normal Extract Screen

The Normal Extract screen enables you to set the Normal airflow speed for the Extract fan in order to balance out any differences in ductwork or other installation features.

Default Normal speed = 30%

See graph on either page 10, 11 or 12 for setting the Extract airflow.

The Normal speed cannot be set below Low speed or above Boost speed setting.

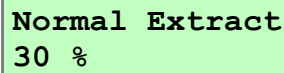

Normal Extract
30 %



Low Supply Screen

The Low Supply screen enables you to set the Low airflow speed for the Supply fan in order to balance out any differences in ductwork or other installation features.

Default Low speed = 20%

See graph on either page 10, 11 or 12 for setting the Supply airflow.

The Low speed cannot be set below 1% or above Normal speed setting.

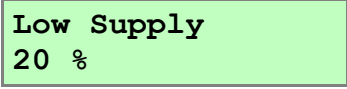

Low Supply
20 %



Low Extract Screen

The Low Extract screen enables you to set the Low airflow speed for the Extract fan in order to balance out any differences in ductwork or other installation features.

Default Low speed = 20%.

See graph on either page 10, 11 or 12 for setting the Extract airflow.

The Low speed cannot be set below 1% or above Normal speed setting.

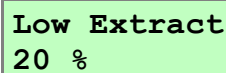

Low Extract
20 %



Cooker Hood Supply Screen

The Cooker Hood Supply screen enables you to set the Boost speed for the Supply fan.

supply speed = 30%

Ckr Hood Supply
100 %



Cooker Hood Extract Screen

The Cooker Hood Extract screen enables you to set the Boost speed for the Extract fan.

Default Cooker Hood speed = 100%

Cooker Hood extract speed cannot be set below Boost speed.

Ckr Hood Extract
100 %



Comfort Mode

This feature delays the LS input boost operation for a maximum of 20 minutes to reduce noise and cold drafts while bathing.

With Comfort Mode enabled, activation of the LS boost is as follows:

1. If the LS input is deactivated within 3 minutes no boost will occur
2. If the LS input is deactivated between 3-20 minutes, an LS boost will be triggered with duration of [Boost Overrun] + [Time LS was active] minutes.
3. If the LS input is active for over [Boost Delay] minutes, an LS boost will activate; when LS is eventually deactivated, the boost will overrun for [Boost Overrun] + [Boost Delay] minutes.

Comfort mode
on



Boost Overrun Screen

The Boost Overrun screen enables you to set a time period for the fans to boost airflow (in minutes) after the light switch (LS input) is turned off. It will then return to normal airflow.

Selectable range: minimum = **00**, maximum = **30**, default = **15**.

Boost Overrun screen does not function for inputs

S/W1 to S/W3 and SW4, SW5

Boost Overrun
15 m



Boost Delay Screen

The Boost Delay screen enables you to set the time delay (in minutes) from the light switch (LS input) being switched on to the airflow boost being activated. This is used to prevent the unit from boosting unnecessarily when the light switch is switched on for short periods.

Selectable range: min. = **00**, max. = **10**, default = **00**.

Boost Delay
00 m



Boost On/Off Screen

The Boost On/Off screen enables you to set a time for boost to be activated for each day of the week.

You can set up to three **On/Off** times per day, shown as **Day1**, **Day2** and **Day3**. If **On** and **Off** times are the same, the unit will not change speed.

On time cannot be set earlier than a previous off time, Likewise, **Off** time cannot be set earlier than a previous **On** time.

To set a weekly schedule:

Setting starts at **Mon1** and uses **SET** to show, by flashing, which item is available for adjustment with the **▲** and **▼** buttons (a → b → c → d → e → **Mon2** and so on).

Mon1 10:01 11:11

↑ ↑ ↑ ↑ ↑
a b c d e

When **Day** flashes, pressing ***** (> 2 sec) will copy yesterday's times to today.

Setting finishes when the last off minutes for **Sun3** are accepted, at which point the screen will now show

All Set or holding the **SET** button for 3 seconds.

Boost On Off
Mon1 00:00 00:00

SET (Day)

▲ ▼

SET (Day)

SET (On)

▲ ▼

SET (On)

Repeat for **Off**
Repeat for each **Day**.

Note: if same times are used on subsequent days, ***** will copy times found.

Boost On Off
All Set

Normal On/Off Screen

The **Normal Airflow** mode can be set to run during the daytime i.e. from 6am to 11pm, the **Low Airflow** mode will then run during the night from 11pm to 6pm.

The Normal On/Off screen enables you to set a time for Normal to be activated for each day of the week.

You can set up to one **On/Off** time per day, If **On** and **Off** times are the same, the unit will not change speed.

On time cannot be set earlier than a previous off time, Likewise, **Off** time cannot be set earlier than a previous **On** time.

To set a weekly schedule:

Setting starts at **Mon** and uses **SET** to show, by flashing, which item is available for adjustment with the **▲** and **▼** buttons (a → b → c → d → e → **Mon** and so on).

Mon 10:01 11:11

↑ ↑ ↑ ↑ ↑
a b c d e

When **Day** flashes, pressing ***** (> 2 sec) will copy yesterday's times to today.

Setting finishes when the last off minutes for **Sun** are accepted, at which point the screen will now show

All Set or holding the **SET** button for 3 seconds.

Normal On Off
Mon 00:00 00:00

SET (Day)

▲ ▼

SET (Day)

SET (On)

▲ ▼

SET (On)

Repeat for **Off**
Repeat for each **Day**.

Note: if same times are used on subsequent days, ***** will copy times found.

Set Service No Screen

The Set Service No screen enables you to enter the telephone number that should be called for service in the event the unit fault.

Initially the screen is blank. Press **SET** to get a **0**. Use **▲** and **▼** buttons to change between **0** and **9** (or blank). Repeat until the number is entered. Finally, select a blank and press **SET** to finish. Maximum **16** digits.

Press and hold ***** for more than 2 seconds to clear service number.

Set Service No

SET

▲ ▼

SET

Internal Humidity Sensor Screen (if fitted)

The Humidity Sensor screen enables you to switch the Sensor **On** and adjust the trigger point between 50% and 90%. (default setting 70%).

Humidity Sensor
Off

SET

▲ ▼

SET

Humidity Rapid-Rise (RH RR) Overrun

The Sentinel kinetic does not just look for relative humidity levels above a set point, which can be unreliable in products that extract from multiple rooms, but it also looks for rapid increase in relative humidity typically generated by such activities as showering or cooking. This feature allows an overrun of up to 60 minutes from a "Rapid rise" of humidity.

RH RR Overrun

SET

▲ ▼

SET

Proportional 1 Screen

The Proportional 1 screen enables the conditions of the proportional sensors to be set.

The unit can receive a 0-10 V proportional signal from either a humidity, CO₂ or temperature external sensor, when connected to terminals P1.

By default, the Proportion 1 input is set for a humidity sensor operation.

When you have selected the sensor type, screens for the appropriate boost and normal limits are displayed.

Press **SET** and use the **▲** and **▼** buttons to change the selection (**Humidity**-default, **CO₂**, **Temperature**, **Pure 0-10V**).

When the input signal is below the 'Normal Limit', the unit runs at low / normal airflow. When the signal is above the 'Boost Limit', the unit runs at boost airflow. Between these limits the unit runs at a proportional airflow.

For a humidity sensor, a percentage value must be entered for boost and normal settings. For range and default values, see *Table 2* below.

For a CO₂ sensor, a figure (in ppm) must be entered for boost and normal settings. For range and default values, see *Table 2* below.

For a Temperature sensor, a figure (in degrees C) must be entered for boost and normal settings. For range and default values, see *Table 2* below.

For a pure 0V to 10V input, anything below 0.1V will be no proportional boost, >9.9V for full boost

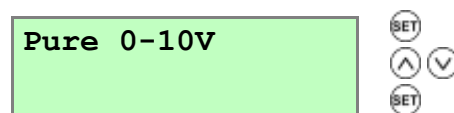
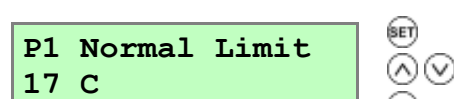
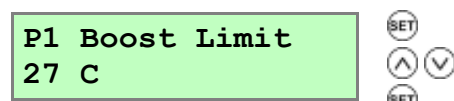
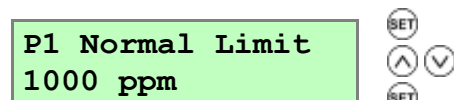
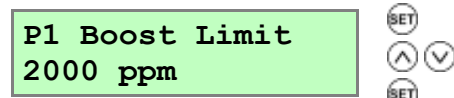
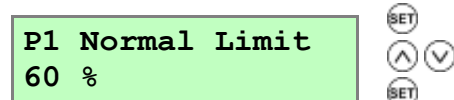
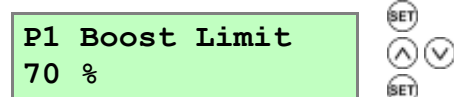
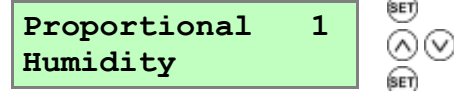

Table 2: Boost & Normal Limits – Defaults and Adjustment Range

Sensor	Humidity		CO ₂		Temperature		Pure 0-10V
	Default (%)	Range (%)	Default (ppm)	Range (ppm)	Default (°C)	Range (°C)	Range (V)
Boost limit	70	25-90	2000	200-2000	27	10-35	9.9
Normal limit	60	25-90	1000	200-2000	17	10-35	0.1

Proportional 2 Screen

By default, the Proportional 2 input is set to CO₂ sensor operation.

See *Proportion 1 Screen* for a description.

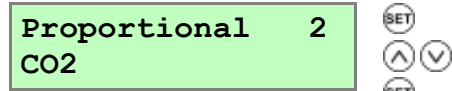

SW5 Screen

To select between boost or low flow

Default = Boost



Boost Button

The Boost Button screen allows the boost button on the front of the unit and on a remote control, if fitted, to be disabled by setting to **Off**. When set to **Off** this also disables the Purge function.

Available options = **On** (default) and **Off**.

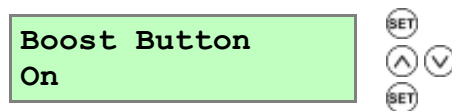

CVP Control (Currently unavailable option)

This screen by default displays CV mode. The unit can operate by choosing Constant Volume or Constant Pressure, or can be set to Off to run on fan curve. Default for standard unit is Off and for CVP unit is CV.

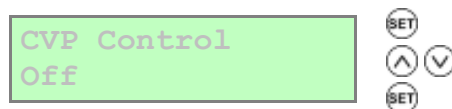

Summer Bypass Screen

The Summer Bypass screen is factory set if one has been fitted. It will only need resetting if a replacement control board has been fitted.

Available options = **Not fitted** (default) and **Fitted**.

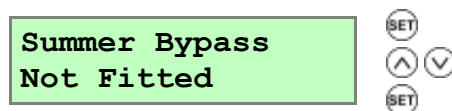

Antifrost Screen

The Antifrost screen is only displayed if a summer bypass is fitted. In installations where a negative pressure is not permitted such as where an open flue fireplace or appliance is fitted, set this to bypass mode.

Standard available options are **Airflow Mode** (default) and **Bypass Mode**.

An additional option is **Anti Frost with Heater Mode** which should be selected if a pre heater is fitted. See the next screen, below. (Currently unavailable option).

Airflow Mode - When the supply air temperature is between 0° and -20°C, antifrost will automatically activate. This will reduce the supply airflow rate and increase the extract airflow rate to prevent frost forming on the heat exchanger. During antifrost operation the supply motor can stop for 15 minutes per hour and run for 45, depending on the temperature below 0°C. If the supply air temperature is -20°C or below the supply fan switches off and the extract fan continues to run at reduced rate to prevent frost forming on the heat exchanger.

Bypass Mode - While the supply air temperature is below 0°C, the antifrost mode will automatically activate. This mode will open the bypass to prevent frost forming on the heat exchanger.

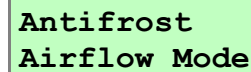

Antifrost
Airflow Mode



Pre Heater Screen (Currently unavailable option)

If an electrical pre heater is being used in conjunction with the anti-frost system to prevent freezing of the heat recovery cell then this is set to **On**. The pre heater control must be wired up according to its instructions. See Appendix 2, options and Accessories, 407198, Anti-Frost Heater Controller.

Otherwise leave set to **Off**.

Note that if any sensor or other input requires the supply fan to stop, then the heater is switched off first and the supply fan runs on for 60 seconds before it is switched off in order to ensure that the heater is cooled.

Available options: **Off** (default) and **On**.



Pre Heater
Off



Dryout Screen

The Dryout screen enables the fans to be run at max speed for a week before returning to normal operation. This feature can help to dry out fresh plaster and paint enabling building work to be completed more quickly.

Filters may become fouled during this time and should be cleaned or replaced afterwards.

Available options: **Off** (default) and **On**.

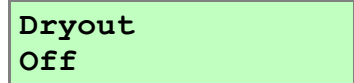

Dryout
Off



Running Time Screen

The Running Time screen displays the total running time of the unit (in hours).

No changes may be made to this screen. In the event of power failure total time will be retained.

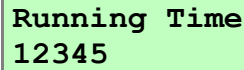

Running Time
12345

Filter Service

Press **SET** and then use the **▲** and **▼** push-buttons to select the time between Filter Services. The options are Urban (6 months), Suburban (default: 12 months) or Rural (18 months).

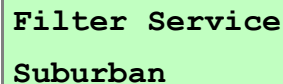

Filter Service
Suburban

B
B
B

BMS screen

On for BMS (default) or **Off** for Wired Remote Control, automatically set up by BMS signal or Wired Remote Control when either is plugged into BMS socket.

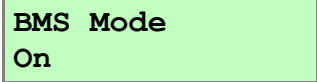

BMS Mode
On

The BMS screen displays byte count and first 16 bytes from the Building Management System (BMS) system. The output may be controlled by a BMS system to switch the unit on or off for example in conjunction with a smoke alarm.



BMS 00

No changes may be made to this screen.

Security PIN Screen

The Security PIN screen enables you to set a four-digit personal identification number (PIN) to access the commissioning screens. This screen will show blank if security is disabled and no PIN is used.

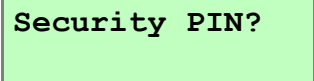

Security PIN?

Press **SET** to reveal **0000** with the first **0** flashing and use the **▲** and **▼** buttons to change the selection (**0-9**). Press **SET** again to accept the digit and move to the next. Repeat until all four digits are specified.

Press and hold ***** for more than 2 seconds to clear security PIN.

Restore Defaults Screen

The Restore Defaults screen enables you to restore the default settings for all screens.

Available options: **No** (default) and **Yes**.

The default commissioning settings are present when the unit is switched on and can be restored by setting the Restore Defaults screen to **Yes**



Restore Defaults
No



Table 3: Default Settings

Parameters	Settings
Start-up Screens	
Sentinel Kinetic	Sentinel Kinetic
Language	English.
Control Mode	01
Airflow Units	%.
Commissioning Screens	
Security PIN	Not set
Boost Supply/Extract	50 %
Normal Supply/ Extract	30 %
Low Supply/Extract	20%
Cooker Hood supply / extract	30% / 100%
Comfort Mode	off
Boost Overrun	15
Boost Delay	00
Boost On/Off	All days set to 0:00 (on), 00:00 (off) – inactive
Normal On Off	All days set to 0:00 (on). 00:00 (off) – inactive
Set Service No	Not set
Humidity	70%
Proportional 1	Humidity – Boost, Normal (60 %) CO ₂ – Boost (2000 ppm), Normal (1000 ppm) Temperature – Boost (27 C, Normal (17 C)
Proportional 2	CO ₂ – Boost (2000 ppm), Normal (1000 ppm) Temperature – Boost (27 C, Normal (17 C) Humidity – Boost, Normal (60 %)
SW4	Off
SW5	Boost
Boost Button	On
Summer Bypass	Not Fitted
Antifrost	Airflow Mode
Dryout	Off
Running Time	-
Filter Service	Suburban (default) 12 months, or can be set to Urban and Rural
BMS	On
Restore Defaults	Off
User Screens	
Set Clock	-
Summer Bypass	Summer Bypass On
Indoor Temp	25 C
Outdoor Temp	14 C

Maintenance

Heat recovery units, by their very nature, require regular maintenance. The Sentinel Kinetic has been designed to facilitate access to enable maintenance to be carried out easily.



WARNING
THE FAN AND ANCILLARY CONTROL EQUIPMENT MUST BE ISOLATED FROM THE POWER SUPPLY DURING MAINTENANCE.

Filter Maintenance

Item	Action
Fan Filters	<p>When the unit displays “Check filters”. This is a reminder to ensure that the filters are not so dirty that they are blocking the airflow or allowing dirt to pass through. The rate at which the filters become dirty will vary hugely depending on the environment and the activity within the property.</p> <ol style="list-style-type: none"> 1. Open the filter flaps and remove the 2 filters. 2. Clean gently by tapping or carefully using a vacuum cleaner if necessary. 3. Replace the filters 4. Close the filter flaps. 5. To Reset the filter service time:- <ol style="list-style-type: none"> i) press and hold the and buttons for 5 seconds until “Reset Filter?” is shown. ii) Press to confirm reset “Filter Reset” will be shown.

Periodic Maintenance

Item	Action
Fan Filters (Interval to suit environment)	<p>Change the Fan Filters depending on which environment the unit has been installed; urban, suburban or rural.</p> <ol style="list-style-type: none"> 1. Open the filter flaps and remove the 2 filters. 2. Insert the replacement filters. 3. Close the filter flaps. 4. To Reset the filter service time:- <ol style="list-style-type: none"> i) press and hold the and buttons for 5 seconds until “Reset Filter?” is shown. ii) Press to confirm reset “Filter Reset” will be shown.
Unit & Heat Exchanger Cell	<p>Inspect and clean the unit</p> <ol style="list-style-type: none"> 1. Isolate the mains power supply. 2. Remove front cover from the unit. 3. Remove the 2 filters. 4. Slide out the heat exchanger. 5. Wash the outer cover and heat exchanger in warm water using a mild detergent and dry thoroughly. <p>NOTE: Keep water away from all electrical components and wiring within the unit.</p>
Motors	<p>Inspect the motors for build-up of dust and dirt on the impeller blades, which could cause imbalance and increased noise levels. Vacuum or clean if necessary.</p>
Condensate Drain	<p>Check the condensate drain tube is secure and clear of debris. Clean if necessary.</p>
Fastenings	<p>Check that all unit and wall-mount fastenings are sufficiently tight and have not become loose. Re-tighten if necessary.</p>

Spares

The following spares may be ordered from Vent-Axia:

Part No	Description
497808	Control PCBA & Patch Cable Kit
497814	Sensor Leads & Patch Cable Kit
SENTINEL KINETIC B/BH SPARES	
442356	G3 Filters, 2 per pack (438222 & 438242)
444199	M5 Single Filter (438222 & 438242)
441764	Heat Recovery Cell (bypass version 438222)
441996	Heat Recovery Cell (non-bypass version 438242)
497812	Supply Motor & Cable Kit
497810	Extract Motor & Cable Kit
441776	Summer Bypass
438378	Spigot, one per pack
SENTINEL KINETIC F SPARES	
409764	G3 Filters, 2 per pack
472153	M5 Single Filter
409766	Heat Recovery Cell
497816	Motor Assembly & Patch Cable Kit
409772	Summer Bypass
409774	Spigot, one per pack
SENTINEL KINETIC PLUS SPARES	
403702	G3 Filters, 2 per pack
444201	M5 Single Filter
443352	Heat Recovery Cell
497818	Motor Assembly & Patch Cable Kit
443355	Summer Bypass
444057	Spigot diameter 150 mm, one per pack
446523	Spigot diameter 180 mm, one per pack, complete with foam adaptor to make 200mm spigot.
SENTINEL KINETIC HIGH FLOW SPARES	
403702	G3 Filters, 2 per pack
444201	M5 Single Filter
443352	Heat Recovery Cell
497820	Motor Assembly & Patch Cable Kit
443355	Summer Bypass
446523	Spigot diameter 180 mm, one per pack, complete with foam adaptor to make 200mm spigot.

Troubleshooting

Diagnosing a Problem

In the event of a problem, always troubleshoot the unit according to:

- **Fault code** displayed on the Control Unit.
- **Fault LED** if connected.

If no indications are displayed, then troubleshoot problem according to the fault symptom as described in the following tables.

Service/Fault Code Screens

The Service screen is displayed, alternating with the Fault Code screen, when a fault has caused the unit to switch off and you must phone the telephone number displayed on the screen for assistance.

Service Phone
01293nnnnnn

The Fault Code screen is displayed, alternating with the Service screen, when a fault has occurred. Take note of the fault code when reporting a fault.

Fault Code
01

For assistance contact the service provider and quote the fault code number.

Note that the fault code is not displayed until the fault has been present for 3 minutes.

The following fault codes numbers may be displayed.

Code numbers are added together if more than one fault is detected.

For example: Code 03 indicates that both supply and extract fans are not running.

Table 4: Fault Codes

Code	Problem
01	Supply Fan not running
02	Extract Fan not running
08	Temperature sensor T1 (supply) faulty
16	Temperature sensor T2 (extract) faulty
32	Wired Remote Control failure

Room Too Cold Screen

The Room Too Cold screen displays the status of the fan. If the heating system in the building fails or is switched off and the internal temperature drops below 5°C, the unit will stop running so as to not bring cold air into an already cold house. The unit will start up every hour and will run for a short time to measure the temperature of the property. When the temperature rises, e.g. the heating system is switched back on, the unit will restart and continue normal operation.

Bottom line of display may be (**Fan Off, Fan Restarting**).

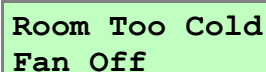

Room Too Cold
Fan Off

Note: Access to the commissioning screens is prevented if the display shows **Antifrost Active, Room Too Cold** or a **Fault Code**. In this event, switch the unit off and on again and enter the commissioning screens within one minute. If you are within the commissioning screens the Antifrost and Room Too Cold Failures modes will not operate allowing the flow rates to be adjusted even in a property which is below 5C.

Appendix One: Control Mode 02 Description

Overview

The functional differences described in this Appendix are available when Control Mode 02 is selected from the start-up screens. Control Mode 02 assigns alternative functions to certain wiring Terminal Connections and allows additional airflow settings to be accessed via the  button on the front of the Kinetic unit or remote control.

N.B.1. If control mode 02 is selected then SW5 must have a link connecting the + and – terminals or a normally closed device such as a fire system.

N.B.2. Accessories will not function if Control Mode 2 is selected.

Terminal Connections and Functions

The following switching Functions are available with Control Mode 02:

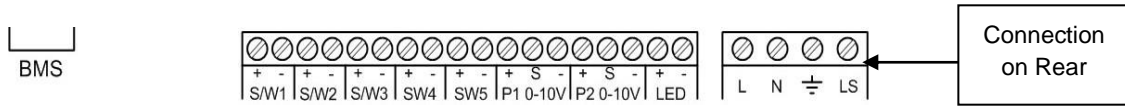

Terminal No.	Name	Description (Control Mode 02)
S/W1	Switch 1	With link fitted to J4 – Volt- free switch – Low Mode
S/W2	Switch 2	With link fitted to J4 – Volt- free switch – Normal Mode
S/W3	Switch 3	With link fitted to J4 – Volt- free switch – Boost Mode
S/W4	Switch 4	Volt-free contact for sensor input between + and – terminals (Momentary if SW/4 if SW4 Commissioning Screen set On)
S/W5	Switch 5	Fire System or SW/5 open Stop
P1 0-10V	Proportional 1	A 24 V DC sensor supply is output between the + and - terminals. A 10 V proportional sensor input is received between S and - terminals
P2 0-10V	Proportional 2	A 24 V DC sensor supply is output between the + and - terminals. A 10 V proportional sensor input is received between S and - terminals
LED	Red Light Emitting Diode Output	A LED driving signal output between the + and – terminals that enables remote indication of a unit fault. See the Control Panel for fault code (see <i>Service/Fault Code Screens</i> on page 42).
L	Mains Live	220-240 V AC, 50 Hz input
N	Mains Neutral	220-240 V AC, 50 Hz input
EARTH	Mains Earth	Earthing connector
LS	Switched Live	220-240 V AC, 50 Hz input

Airflow Mode Selection

The following switching Functions are available via the  button with Control Mode 02:

No. of presses	Airflow Mode (Control Mode 02)
1	Low
2	Normal
3	Boosts 30 minutes
4	Boosts 60 minutes
5	Boosts continuously
6	Cancel

Press  10 seconds after last press to cancel and return to normal operation.

If the wireless boost option is fitted, this can be triggered from the wireless transmitter/boost switch.

If the installation has switch sensors, is wired to the lighting, or if the internal time switch is set for periodic operation, then operation will change from normal to boost automatically. Pressing the  button will reveal a code to show which device has activated boost.

s4 = Switch SW4

v1 = S/W1

v2 = S/W2

v3 = S/W3

ls = Switched live (LS)

c1-3 = Internal Time switch

If running on boost due to pressing the  button, another device may 'take over' the boost. Flow will return to normal when that device switches off. If a number of different devices are calling for boost flow, the unit will run at boost until the last one has reverted to normal.

Appendix Two: Options and Accessories

CO2 Sensor

An optional wall-mounted CO₂ Sensor (433257) may be used to control airflow. The CO₂ sensor measures the CO₂ level in ppm (parts per million) and the unit adjusts the fan speed accordingly. When the CO₂ level is below the lower threshold (adjustable), the fan will run at Normal speed. When the CO₂ level is above the upper threshold (also adjustable), the fan will run at Boost speed. If the CO₂ level is between the lower and upper thresholds, the fan will run at a speed between Normal and Boost proportional to the difference between the CO₂ level and the thresholds.

Normal / Boost Switch

An optional Normal/Boost Switch (455213) may be used to control airflow. Connecting a switch will enable a manual control to be used in conjunction with other boost controls.

Humidistats

An internal Relative Humidity Sensor PCB (495976) may be used to control airflow. The unit adjusts the fan speed proportionally depending on the temperature and relative humidity levels in the extracted air whilst avoiding nuisance tripping at night time when temperatures drop and relative humidity naturally rises. The unit does not just look for relative humidity levels above a set point, which can be unreliable in products that extract from multiple rooms, but it also looks for rapid increase in relative humidity typically generated by such activities as showering or cooking.

Connecting a System Cooker Hood

A system cooker hood that has a Switched Live output to trigger the unit from normal to cooker hood boost can be connected as follows. The cooker hood must be double insulated.

1. Remove a blind grommet from the Cable Inlet plate and insert the 3 core cable from Cooker hood.
2. Connect the 3 wires to the terminal block marked J12
 - Brown = L
 - Grey = N
 - Black = LS

Connecting an Opto-coupler (447340)

The LED terminals are intended to drive a remote LED to indicate that a fault has occurred. They provide a LED driving signal output between the + and – terminals that enables remote indication of a unit fault. See the Control Panel for fault code (Refer to installation and commissioning guide listed above). This signal could also be used by a BMS system so that it is informed that a fault has occurred. If a volt-free contact is required then use this opto-coupler to provide electrical separation.

Connect the flying leads of the opto-coupler pcb into the LED terminals, + to + and - to -
Connect the pair of leads from the BMS to the terminal block of the opto-coupler pcb.

Wired Remote Control (443283)



1. The Wired Remote Control uses 15 metre long cable and has the same functionality as the control mounted on the unit, it can be permanently mounted in a living space for the end user or used for commissioning the unit.
2. To fit the Wired Remote Control remove the Front, Rear and Electrical covers, using the cable assembly supplied insert the plug into the socket marked BMS and feed the remaining cable through cable inlet plate, refit all covers.

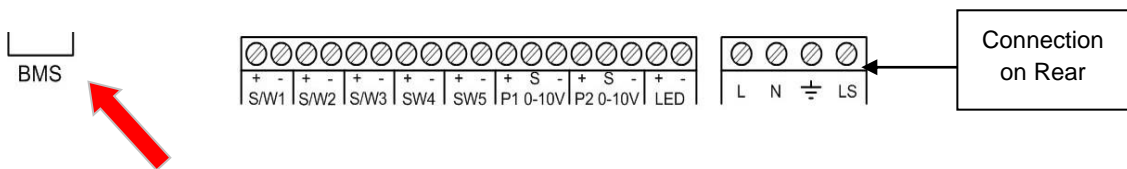

3. Connect the cable assembly (4 wires numbered 1 to 4) to the Remote Control terminal block and mount onto a single gang recessed wall box with the 2 screws provided. The Wired Remote Control will automatically be detected.



Isolator Relay Controller (442030)

The isolating relay controller allows several LS signals to be combined from independent circuits. For instance, from lighting circuits on different floor levels.

Remote LED Indicator (448347)



The LED terminals are intended to drive a remote LED to indicate that there is a message in the control display.

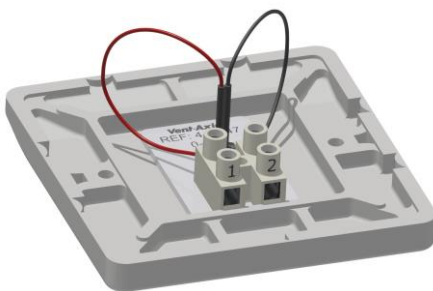

They provide a LED driving signal output between the + and – terminals that enables remote indication of filter check or unit fault. See the Control Panel for message (See page 45 for fault codes).

Connect the 2 core flying lead from the Remote LED indicator terminal block. Terminal 1 on the Remote LED is + and terminal 2 is -

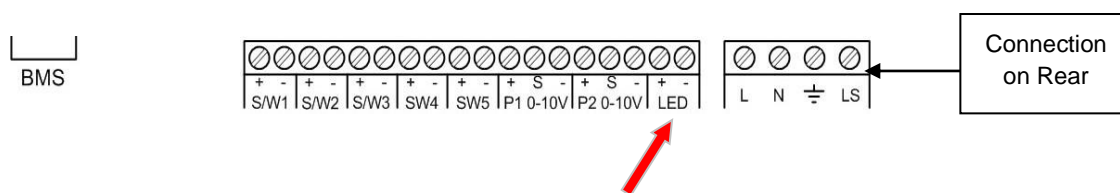

Connect the other end of the lead to the LED + &- terminals on the Kinetic unit PCB. Please ensure that the + goes to + and the – goes to -.

PRODUCT FICHE

For Residential Ventilation Units (Complying Commission Delegated Regulation (EU) No 1254/2014)

Name:	Vent-Axia	Vent-Axia	Vent-Axia
Model ID (Stock Ref.) :	Kinetic B / L - 438222/ L	Kinetic BH /L- 443319/ L	Kinetic Plus B - 443028/L
SEC Class	A	A	A+
SEC Value ('Average')	-41.41	-41.41	-43.81
SEC Value ('Warm')	-16.49	-16.49	-18.55
SEC Value ('Cold')	-85.69	-85.69	-88.70
Label Required? (Yes/No=Out of scope)	Yes	Yes	Yes
Declared as: RVU or NRVU/UVU or BVU	RVU/BVU	RVU/BVU	RVU/BVU
Speed Drive	Variable Speed	Variable Speed	Variable Speed
Type HRS (Recuperative, Regenerative, None)	Recuperative	Recuperative	Recuperative
Thermal Eff: [(%), NA(if none)]	87.00	87.00	90.00
Max. Flow Rate (m3/h)	237.60	237.60	432.00
Max. Power Input (W): (@Max.Flow Rate)	128.00	128.00	173.00
LWA: Sound Power Level (dB)	52.13	52.13	52.23
Ref. Flow Rate (m3/s)	0.04620	0.04620	0.08400
Ref. Pressure Diff. (Pa)	50.00	50.00	50.00
SPI [W/(m3/h)]	0.34	0.34	0.20
Control Factor & Control Typology: (CTRL/ Typology)			
Control Factor; CTRL	0.65	0.65	0.65
Control Typology	Local Demand Control	Local Demand Control	Local Demand Control
Declared: -Max Internal & External Leakage Rates(%) for BVUs or carry over (for regenerative heat exchangers only), -&Ext. Leakage Rates (%) for Ducted UVUs;	<5% Internal, <5% External	<5% Internal, <5% External	<5% Internal, <5% External
Mixing Rate of Non-Ducted BVUs not intended to be equipped with one duct connection on either supply or extract air side;	N/A	N/A	N/A
Position and description of visual filter warning for RVUs intended for use with filters, including text pointing out the importance of regular filter changes for performance and energy efficiency of the unit	Refer to User Instructions	Refer to User Instructions	Refer to User Instructions
For UVUs (Instructions Install Regulated Supply/Extract Grilles Façade)	N/A	N/A	N/A
Internet Address (for Disassembly Instructions)	www.vent-axia.com	www.vent-axia.com	www.vent-axia.com
Sensitivity p. Variation@+20/-20 Pa: (for Non-Ducted VUs)	N./A	N./A	N./A
Air Tightness-ID/OD-(m3/h) (for Non-Ducted VUs)	N./A	N./A	N./A
Annual Electricity Consumption: AEC (kWh/a) Per. 100m ²	2.23	2.23	1.52
Annual Heating Saved: AHS (kWh/a) Per. 100m ²			
AHS: Average	46.31	46.31	46.93
AHS: Warm	20.94	20.94	21.22
AHS: Cold	90.60	90.60	91.82

PRODUCT FICHE

For Residential Ventilation Units (Complying Commission Delegated Regulation (EU) No 1254/2014)

Name:	Vent-Axia
Model ID (Stock Ref.) :	Kinetic High Flow / L - 408449 / 408451
SEC Class	A
SEC Value ('Average')	-40.98
SEC Value ('Warm')	-15.72
SEC Value ('Cold')	-85.86
Label Required? (Yes/No=Out of scope)	Yes
Declared as: RVU or NRVU/UVU or BVU	RVU/BVU
Speed Drive	Variable Speed
Type HRS (Recuperative, Regenerative, None)	Recuperative
Thermal Eff: [(%), NA(if none)]	90.00
Max. Flow Rate (m3/h)	666.00
Max. Power Input (W): (@Max.Flow Rate)	360.00
LWA: Sound Power Level (dB)	61.03
Ref. Flow Rate (m3/s)	0.12950
Ref. Pressure Diff. (Pa)	50.00
SPI [W/(m3/h)]	0.42
Control Factor & Control Typology: (CTRL/ Typology)	
Control Factor; CTRL	0.65
Control Typology	Local Demand Control
Declared: -Max Internal & External Leakage Rates(%) for BVUs or carry over (for regenerative heat exchangers only), -&Ext. Leakage Rates (%) for Ducted UVUs;	<5% Internal, <5% External
Mixing Rate of Non-Ducted BVUs not intended to be equipped with one duct connection on either supply or extract air side;	N/A
Position and description of visual filter warning for RVUs intended for use with filters, including text pointing out the importance of regular filter changes for performance and energy efficiency of the unit	Refer to User Instructions
For UVUs (Instructions Install Regulated Supply/Extract Grilles Façade)	N/A
Internet Address (for Disassembly Instructions)	www.vent-axia.com
Sensitivity p. Variation@+20/-20 Pa: (for Non-Ducted VUs)	N/A
Air Tightness-ID/OD-(m3/h) (for Non-Ducted VUs)	N/A
Annual Electricity Consumption: AEC (kWh/a) Per. 100m ²	2.65
Annual Heating Saved: AHS (kWh/a) Per. 100m ²	
AHS: Average	46.93
AHS: Warm	21.22
AHS: Cold	91.82

PRODUCT FICHE

For Residential Ventilation Units (Complying Commission Delegated Regulation (EU) No 1254/2014)

Name:	Vent-Axia
Model ID (Stock Ref.) :	Kinetic FH – 408167 /FHL 408169
SEC Class	A+
SEC Value ('Average')	-42.51
SEC Value ('Warm')	-17.25
SEC Value ('Cold')	-87.39
Label Required? (Yes/No=Out of scope)	Yes
Declared as: RVU or NRVU/UVU or BVU	RVU/BVU
Speed Drive	Variable Speed
Type HRS (Recuperative, Regenerative, None)	Recuperative
Thermal Eff: [(%), NA(if none)]	90
Max. Flow Rate (m3/h)	331.2
Max. Power Input (W): (@Max.Flow Rate)	168
LWA: Sound Power Level (dB)	61.03
Ref. Flow Rate (m3/s)	0.064
Ref. Pressure Diff. (Pa)	50
SPI [W/(m3/h)]	0.30
Control Factor & Control Typology: (CTRL/ Typology)	
Control Factor; CTRL	0.65
Control Typology	Local Demand Control
Declared: -Max Internal & External Leakage Rates(%) for BVUs or carry over (for regenerative heat exchangers only), -&Ext. Leakage Rates (%) for Ducted UVUs;	<5% Internal, <5% External
Mixing Rate of Non-Ducted BVUs not intended to be equipped with one duct connection on either supply or extract air side;	N/A
Position and description of visual filter warning for RVUs intended for use with filters, including text pointing out the importance of regular filter changes for performance and energy efficiency of the unit	Refer to User Instructions
For UVUs (Instructions Install Regulated Supply/Extract Grilles Façade)	N/A
Internet Address (for Disassembly Instructions)	www.vent-axia.com
Sensitivity p. Variation@+20/-20 Pa: (for Non-Ducted VUs)	N/A
Air Tightness-ID/OD-(m3/h) (for Non-Ducted VUs)	N/A
Annual Electricity Consumption: AEC (kWh/a) Per. 100m ²	2.04
Annual Heating Saved: AHS (kWh/a) Per. 100m ²	
AHS: Average	46.93
AHS: Warm	21.22
AHS: Cold	91.82

The **Vent-Axia** Guarantee

Applicable only to products installed and used in the United Kingdom. For details of guarantee outside the United Kingdom contact your local supplier.

Vent-Axia guarantees its products for two years from date of purchase against faulty material or workmanship. In the event of any part being found to be defective, the product will be repaired, or at the Company's option replaced, without charge, provided that the product:-

- Has been installed and used in accordance with the instructions given with each unit.
- Has not been connected to an unsuitable electricity supply. (The correct electricity supply voltage is shown on the product rating label attached to the unit).
- Has not been subjected to misuse, neglect or damage.
- Has not been modified or repaired by any person not authorised by the company.

IF CLAIMING UNDER TERMS OF GUARANTEE

Please return the complete product, carriage paid to your original supplier or nearest Vent-Axia Centre, by post or personal visit. Please ensure that it is adequately packed and accompanied by a letter clearly marked "Guarantee Claim" stating the nature of the fault and providing evidence of date and source of purchase.

The guarantee is offered to you as an extra benefit, and does not effect your legal rights

Vent-Axia

Head Office: Fleming Way, Crawley, West Sussex, RH10 9YX.

EU Authorised Representative: Vent-Axia Sigarenmaker 5 - 5521DJ Eersel Nederland authorisedrep@vent-axia.nl

UK NATIONAL CALL CENTRE, Newton Road, Crawley, West Sussex, RH10 9JA

SALES ENQUIRIES: Tel: 0344 856 0590

TECHNICAL SUPPORT Tel: 0344 856 0594

For details of the warranty and returns procedure please refer to www.vent-axia or write to Vent-Axia Ltd, Fleming Way, Crawley, RH10 9YX